

Common Structural Rules for Bulk Carriers and Oil Tankers

Urgent Rule Change Notice 1 to 01 JAN 2014 version

Copyright in these Common Structural Rules is owned by each IACS Member as at 1st January 2014.
Copyright © IACS 2014.

The IACS members, their affiliates and subsidiaries and their respective officers, employees or agents (on behalf of whom this disclaimer is given) are, individually and collectively, referred to in this disclaimer as the "IACS Members". The IACS Members assume no responsibility and shall not be liable whether in contract or in tort (including negligence) or otherwise to any person for any liability, or any direct, indirect or consequential loss, damage or expense caused by or arising from the use and/or availability of the information expressly or impliedly given in this document, howsoever provided, including for any inaccuracy or omission in it. For the avoidance of any doubt, this document and the material contained in it are provided as information only and not as advice to be relied upon by any person.

Any dispute concerning the provision of this document or the information contained in it is subject to the exclusive jurisdiction of the English courts and will be governed by English law.

COMMON STRUCTURAL RULES FOR BULK CARRIERS AND OIL TANKERS

URGENT RULE CHANGE NOTICE 1

This proposal contains amendments within the following Parts and chapters of the Common Structural Rules for Bulk Carriers and Oil Tankers, 1 January 2014. The amendments are effective on 1 July 2015.

For technical background for Rule Changes in this present document, reference is made to separate document Technical Background for this Rule Change Proposal.

PART 1

CHAPTER 4 LOADS

SECTION 4 HULL GIRDER LOADS

3.4.1

The wave torsional moment at any longitudinal position with respect to the ship baseline, in kNm, is to be taken as:

$$M_{wt} = f_p (M_{wt1} + M_{wt2})$$

where:

$$M_{wt1} = 0.4 f_{t1} C_w \sqrt{\frac{L}{T_{LC}}} B^2 DC_B$$

$$M_{wt2} = 0.22 f_{t2} C_w LB^2 C_B$$

f_{t1}, f_{t2} : Distribution factors, taken as:

$$\begin{aligned} f_{t1} &= 0 && \text{for } x < 0 \\ f_{t1} &= \left| \sin\left(\frac{2\pi x}{L}\right) \right| && \text{for } 0 \leq x \leq L \\ f_{t1} &= 0 && \text{for } x > L \\ f_{t2} &= 0 && \text{for } x < 0 \\ f_{t2} &= \sin^2\left(\frac{\pi x}{L}\right) && \text{for } 0 \leq x \leq L \\ f_{t2} &= 0 && \text{for } x > L \end{aligned}$$

f_p : Coefficient to be taken as:

$$f_p = f_{ps} \quad \text{for strength assessment.}$$

~~$$f_p = 0.9[0.24 + (6f_T - 5)B \times 10^{-4}] \quad \text{for fatigue assessment.}$$~~

$$f_p = 0.9[0.2 + (5f_T - 4.25)B \times 10^{-4}] \quad \text{for fatigue assessment}$$

CHAPTER 5 HULL GIRDER STRENGTH

1.2.9 Definitions of openings

The following definitions of opening are to be applied:

- a) Large openings are:
 - Elliptical openings exceeding 2.5 m in length or 1.2 m in breadth.
 - Circular openings exceeding 0.9 m in diameter.
- b) Small openings (i.e. ~~manholes~~, lightening holes, etc) are openings that are not large ones.
- c) Manholes
- d) Isolated openings are openings spaced not less than 1 m apart in the ship's transverse/vertical direction.

1.2.10 Large openings, manholes and nearby small openings

Large openings and manholes are to be deducted from the sectional area used in hull girder moment of inertia and section modulus. When small openings are spaced less than 1 m apart in the ship's transverse/vertical direction to large openings or manholes, the total breadth of them is to be deducted from the sectional area.

Additionally, isolated small openings which do not comply with the arrangement requirements given in Ch 3, Sec 6, [6.3.2] are to be deducted from the sectional areas included in the hull girder transverse sections.

CHAPTER 7 DIRECT STRENGTH ANALYSIS

SECTION 2 CARGO HOLD STRUCTURAL STRENGTH ANALYSIS

2.4.9 Openings

Methods of representing openings **and manholes** in webs of primary supporting members are to be in accordance with Table 1. Regardless of size, manholes are to be modelled by removing the appropriate elements. ~~except for manholes which are to be modelled by removing the adequate elements.~~

Table 1 : Representation of openings in primary supporting member webs
(Partial table shown)

Criteria	Modelling decision	Analysis
$h_o/h < 0.5$ and $g_o < 2.0$	Openings do not need to be modelled	<u>To be evaluated by the screening procedure as given in Ch 7, Sec 3, 3.1.1</u>
manholes	<u>The geometry of the opening is to be modelled by removing the adequate elements</u>	<u>To be evaluated by the screening procedure as given in Ch 7, Sec 3, 3.1.1</u>
$h_o/h \geq 0.5$ or $g_o \geq 2.0$	The geometry of the opening is to be modelled	<u>To be evaluated by fine mesh as given in Ch 7, Sec 3, 2.1.1</u>

SECTION 3 SCREENING PROCEDURE

2 LOCAL AREAS TO BE ASSESSED BY FINE MESH ANALYSIS

2.1 List of mandatory structural details

2.1.1 List of structural details

In the midship cargo hold region, the following structural details are to be assessed according to the fine mesh analysis procedure defined in [1.1.3]:

- Hopper knuckles for ship with double side as given in [2.1.2],
- Side frame end brackets and lower hopper knuckle for single side bulk carrier as given in [2.1.3],
- Large openings as given in [2.1.4],
- Connections of deck and double bottom longitudinal stiffeners to transverse bulkhead as given in [2.1.5],
- Connections of corrugated bulkhead to adjoining structure as given in [2.1.6].

For each above mentioned structural detail, one fine mesh model is required within all the cargo hold models covering the midship cargo hold region. The selection of the location of this fine mesh model is to be based on requirements given from [2.1.2] to [2.1.6] from all cargo hold analyses in the midship cargo hold region.

3 SCREENING PROCEDURE

3.2 List of structural details

3.2.1 Cargo hold region

The following structural details and areas in the cargo hold region are to be evaluated by screening:

- a) Openings which do not require modelling and manholes, see Ch 7, Sec 2, [2.4.9] in way of web of primary supporting members, such as transverse web frame as indicated in Table 1 and Table 2, horizontal stringers as indicated in Table 3, floors and longitudinal girders in double bottom.

(Partial list shown)

Table 1: Screening areas of transverse web frame in oil tanker

(Partial table shown)



	Bracket toes	
	Openings and manholes (shaded regions)	
	Other-Openings and manholes (unshaded regions)	Screening check to be performed for openings except if: $h_o/h < 0.35$ and $g_o < 1.2$, and, each end of the opening forms a semi circle arc (i.e. radius of opening equal to $b/2$). This criterion does not apply to manholes which are to be evaluated by screening irrespective of size. h_o , h and g_o is defined in Ch 7, Sec 2, [2.4.9], b is the smallest of the length and breadth of the opening.

Table 2 : Screening areas for transverse web frame in bulk carrier

(Partial table shown)







	Bracket toes	
	Openings and manholes (shaded regions)	
	Other-Openings and manholes (unshaded regions)	Screening check to be performed for openings except if: $h_o/h < 0.35$ and $g_o < 1.2$, and, each end of the opening forms a semi circle arc (i.e. radius of opening equal to $b/2$). This criterion does not apply to manholes which are to be evaluated by screening irrespective of size. h_o , h and g_o is defined in Ch 7, Sec 2, [2.4.9], b is the smallest of the length and breadth of the opening.

Table 3 : Screening areas for horizontal stringer and transverse bulkhead to double bottom connections in oil tanker
(Partial table shown)

	Bracket toes	
	Openings and manholes (shaded regions)	
	Other-Openings and manholes (unshaded regions)	Screening check to be performed for openings except if: $h_o/h < 0.35$ and $g_o < 1.2$, and, each end of the opening forms a semi circle arc (i.e. radius of opening equal to $b/2$). This criterion does not apply to manholes which are to be evaluated by screening irrespective of size. h_o , h and g_o is defined in Ch 7, Sec 2, [2.4.9], b is the smallest of the length and breadth of the opening.

3.2.2 Outside midship cargo hold region

The following structural details outside midship cargo hold region are to be evaluated by screening:

- a) Hopper knuckle, as defined in [2.1.2] and [2.1.3],
- b) Side frame end bracket, as defined in [2.1.3],
- c) Large openings, as defined in [2.1.4],
- d) Connections of corrugation to adjoining structure, as defined in [2.1.6],

The ~~above mentioned structural details~~ **connections of corrugation to adjoining structure** to be screened are to be similar in its geometry, its proportion and its relative location to the corresponding detail modelled in fine mesh in the midship cargo hold region.

When the ~~above mentioned structural details~~ **connections of corrugation to adjoining structure** outside the midship cargo hold region are different from the corresponding detail modelled in fine mesh in the midship cargo hold region, a fine mesh analysis is to be performed for the detail located where the yield utilisation factor, λ_y , is maximum for structural details having the same geometry and the same relative location,

When it is deemed necessary, the Society may request a fine mesh analysis to be performed according to [1.1.3].

3.3 Screening criteria

3.3.1 Screening factors and permissible screening factors

The screening factors, λ_{sc} , and the permissible screening factors, λ_{scperm} , are given in Table 4 for the screening areas defined in [3.1].

Table 4 : Screening factors and permissible screening factors

Type of Details	Screening factors, λ_{sc}	Permissible screening factors, λ_{scperm}	
		S+D	S
Within the whole cargo hold region		S+D	S
Openings for which their geometry is not required to be represented in the cargo hold model in accordance with Ch 7, Sec 2, [2.4.9] in way of webs of primary supporting members, such as transverse web frame as indicated in Table 1 and Table 2, horizontal stringers as indicated in Table 3, floors and longitudinal girders in double bottom.	Table 5	1.70	1.36
Manholes ⁽²⁾	λ_y	0.85 λ_{yperm}	
Bracket toes on transverse web frames as indicated in Table 1 and Table 2, horizontal stringers and transverse plane bulkhead to double bottom connection or buttress structure specified in Table 3.	Table 6	1.50	1.20
Heels of transverse bulkhead horizontal stringers specified in Table 3.	Table 7	1.50	1.20
Connections of transverse lower stool to double bottom girders and longitudinal lower stool to double bottom floors as indicated in Figure 5. The connection of lower hopper to transverse lower stool structure as indicated in Figure 5. The connection of topside tank to inner side as indicated in Figure 6. The connection of corrugation and upper supporting structure to upper stool as indicated in Figure 7.	λ_y	0.75 λ_{yperm}	
Hatch corner area.	λ_y	0.95 λ_{yperm}	
Outside midship cargo hold region			
Hopper knuckle	λ_y	0.65 λ_{yperm}	
Side frame end bracket ⁽²⁾		0.85 λ_{yperm}	
Large openings ⁽²⁾		0.85 λ_{yperm}	
Hopper knuckle	$\lambda_{sc} = \frac{K_{sc} \cdot \sigma_c}{R_Y}$ (1)	1.50 f_f	1.20 f_f
Side frame end bracket⁽²⁾		1.50 f_f	1.20 f_f
Large openings		1.70 f_f	1.36 f_f
Connections of corrugation to adjoining structure		1.50 f_f	1.20 f_f
where:			
λ_y	: Coarse mesh yield utilisation factor, as defined in Ch 7, Sec 2, [5.2.4].		
λ_{yperm}	: Coarse mesh permissible yield utilisation factor, as defined in Ch 7, Sec 2, [5.2.4].		
K_{sc}	: Screening stress concentration factor, taken as:		
	$K_{sc} = \frac{\sigma_{FM}}{\sigma_{CM}}$		
σ_{FM}	: Von Mises fine mesh stress, in N/mm ² , for the considered detail calculated in the midship cargo hold region according to [2].		
σ_{CM}	: Von Mises coarse mesh stress, in N/mm ² , for the considered detail calculated in the midship cargo hold region according to Ch 7, Sec 2.		
σ_c	: Von Mises coarse mesh stress, in N/mm ² , for the area in way of considered detail.		
f_f	: Fatigue factor defined in [6.2.1].		
(1)	For each screened detail, σ_{FM} and σ_{CM} are to be taken from the corresponding elements in the same plane position.		
(2)	For the side frame end brackets of single side bulk carrier, σ_{FM} and σ_{CM} are to be taken at the corresponding elements representing the flange of the end brackets. The representative element which has maximum yield utilisation factor around the manhole and the large opening is to be verified against criterion.		

Table 6 : Screening factor for bracket toes of primary supporting members

λ_{sc}	: Screening factor taken as: $\lambda_{sc} = C_a \left(\frac{0.75}{0.68} \left(\frac{b_2}{b_1} \right)^{0.5} \sigma_{vm} + \frac{0.55}{0.50} \left(\frac{A_{beam-n50}}{b_1 t_{n50}} \right)^{0.5} \sigma_{beam} \right) \frac{k}{235}$
C_a	: Coefficient taken as: $C_a = 1.0 - 0.2 \left(\frac{R_a}{1400} \right)^2$
b_1, b_2	: Height of shell element in way of bracket toe in cargo hold FE model, in mm.
$A_{beam-n50}$: Sectional area of beam or rod element in cargo hold FE model representing the face plate of bracket, in mm ² .
σ_{beam}	: Beam or rod element axial stress determined from cargo hold FE analysis, in N/mm ² .
σ_{vm}	: Von Mises stress of shell element in way of bracket toe determined from cargo hold FE analysis, in N/mm ² .
t_{n50}	: Net thickness of shell element in way of bracket toe, in mm.
R_a	: Leg length, in mm, not to be taken as greater than 1400 mm.

(Partial table shown)

Table 7 : Screening factor for heels of transverse bulkhead horizontal stringers

λ_{sc}	: Screening factor taken as: <ul style="list-style-type: none"> For heels at side horizontal girder and transverse bulkhead horizontal stringer, at the locations 1, 2 and 3 in figure below. $\lambda_{sc} = \frac{3.0}{1.67} \sigma_{vm} \frac{k}{235}$ For heel at longitudinal bulkhead horizontal stringer, at the location 4 in figure below. $\lambda_{sc} = \frac{5.2}{3.2} \sigma_x \frac{k}{235}$
σ_x	: Axial stress in element x direction determined from cargo hold FE analysis in accordance with the coordinate system shown, in N/mm ² .
σ_{vm}	: Von Mises stress of shell element in way of heel determined from cargo hold FE analysis, in N/mm ² .

(Partial table shown)

4.8.4

Diaphragm webs, brackets inside the lower stool and ~~vertical~~ all stiffeners on the stool ~~side plate and diaphragm~~ are to be modelled at their actual positions within the extent of the local model. Shell elements are to be used for modelling of diaphragm, ~~bracket and stiffener webs.~~ Shell elements are to be used to represent the flange of stiffeners web and flange of vertically orientated stiffeners. and brackets in the fine mesh zone.

4.8.5

~~Stiffeners on the lower stool plate are to be represented by beam elements.~~ Horizontally orientated stiffeners within the fine mesh zone are to be represented by either shell or beam elements.

CHAPTER 9 FATIGUE

SECTION 3 FATIGUE EVALUATION

3.1.2 Welded joints

For welded joints, the fatigue stress range $\Delta\sigma_{FS,i(j)}$, in N/mm², corrected for mean stress effect, thickness effect and warping effect, is taken as:

- For simplified stress analysis:

$$\Delta\sigma_{FS,i(j)} = f_{mean, i(j)} \cdot f_{thick} \cdot f_{warp} \cdot \Delta\sigma_{HS, i(j)}$$

- For FE analysis:
 - For web-stiffened cruciform joints:

~~$$\Delta\sigma_{FS,i(j)} = \max(\Delta\sigma_{FS1,i(j)}, \Delta\sigma_{FS2,i(j)})$$~~

...

~~$$\Delta\sigma_{FS,i(j)} = f_w \cdot f_s \cdot \max(\Delta\sigma_{FS1,i(j)}, \Delta\sigma_{FS2,i(j)})$$~~

where:

~~f_w : correction factor for the effect of stress gradient along weld line given as 0.96~~

~~f_s : correction factor for the effect of supporting member given as 0.95~~

...

f_{warp} : Correction factor due to warping effect, taken as:

- $f_{warp} = 1.07$ for the deck longitudinal stiffener of bulk carrier, the closest to the longitudinal hatch coaming in way of the hatch corner as shown in Figure 1, except $f_{warp}=1.0$ when OST is not the dominant load case for all loading conditions
- $f_{warp} = 1.04$ for following deck longitudinal stiffeners of bulk carrier, except $f_{warp}=1.0$ when OST is not the dominant load case for all loading conditions:
 - The closest stiffener to the longitudinal hatch coaming at one web frame away from the hatch corner, in way of the hatch opening as shown in Figure 1,
 - The second closest stiffener away from the longitudinal hatch coaming in way of the hatch corner as shown in Figure 1,
- $f_{warp} = 1.0$ for the other cases.

4.1.5 Corrosive environment

The basic design curves for corrosive environment shown in Figure 4 are represented by linear relationships between $\log(\Delta\sigma)$ and $\log(N)$ as follows:

$$\log(N) = \log(K_2) - m \cdot \log(\Delta\sigma)$$

N : Predicted number of cycles to failure under stress range $\Delta\sigma$.

K_2 : Constant related to design S-N curve as given in Table 3.

Table 3 : Basic S-N curve data, corrosive environment

Class	K_2	m	Design stress range at 2×10^6 cycles, N/mm^2
B_{corr}	2.246E12	3.0	103.9
C_{corr}	1.267E12	3.0	85.9
D_{corr}	7.600E11	3.0	72.4

Class	K_2	m	Design stress range at 2×10^6 cycles, N/mm^2
B_{corr}	<u>5.05×10^{14}</u>	<u>4.0</u>	<u>126.1</u>
C_{corr}	<u>2.12×10^{13}</u>	<u>3.5</u>	<u>101.6</u>
D_{corr}	7.60×10^{11}	3.0	72.4

Figure 4 : Basic design S-N curves, corrosive environment

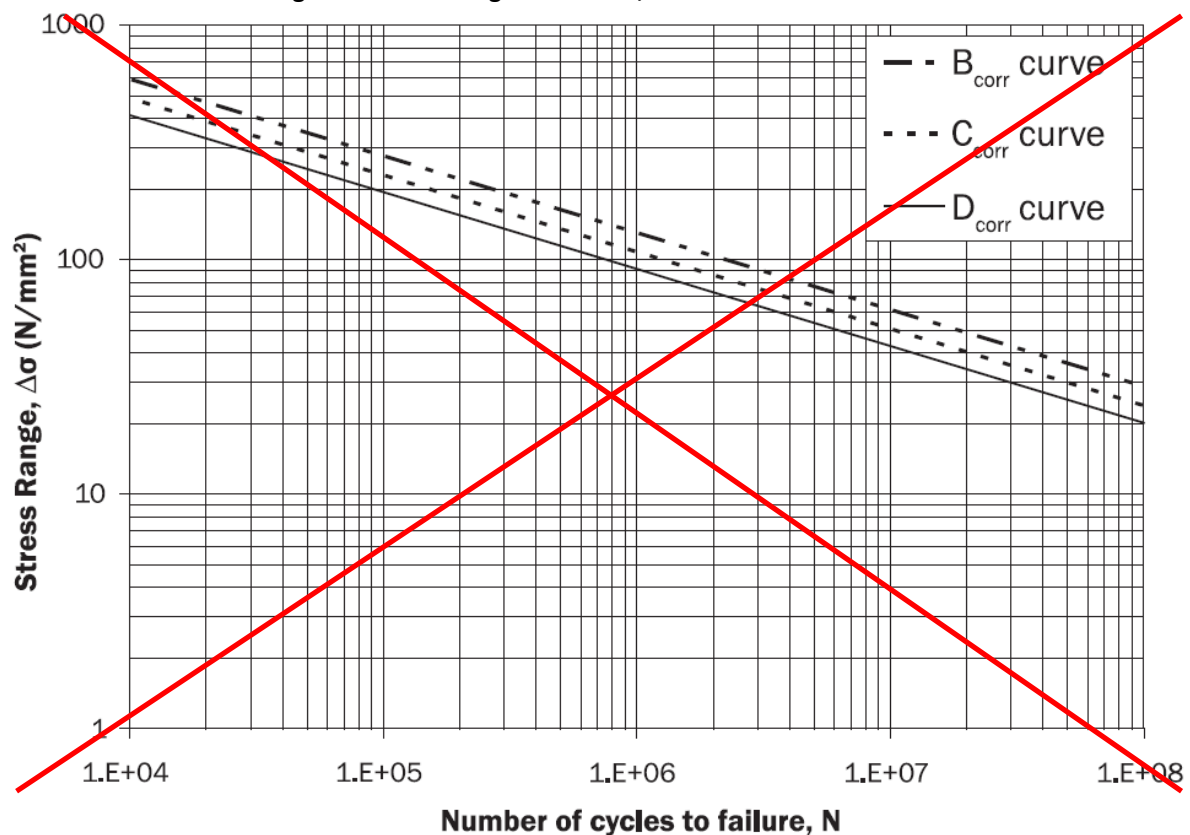

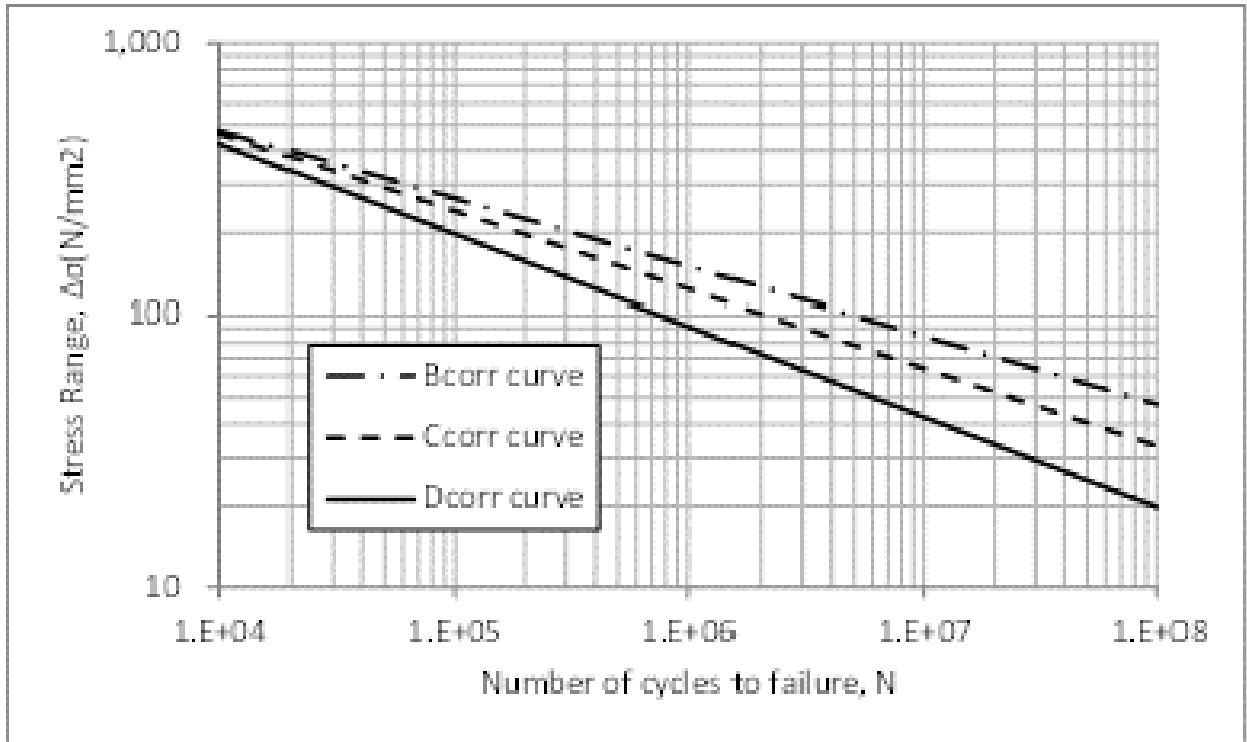

4.2.3 Surface finishing factor

The S-N curve C is applicable to most of non-welded locations taking into account the likelihood of some notching from corrosion, wear and tear in service with surface finishing factor as given in Table 4.

Higher surface finishing quality may be applied in using S-N curve B as given in Table 4, provided adequate protective measures are taken against wear, tear and corrosion [and finite element analysis according Sec 5, \[2\] is carried out.](#)

Table 4 : Non-welded joints: thickness exponent and surface finishing factor

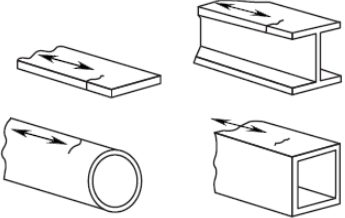
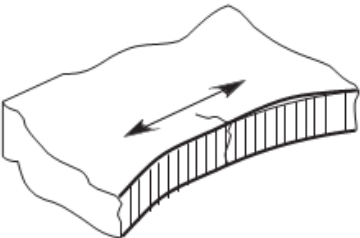
Joint configuration, fatigue crack location and stress direction		Edge cutting process	Edge treatment	Surface finishing	n	K_{sf}	S-N curve
1	<p>Rolled or extruded plates and sections as well as seamless pipes, no surface or rolling defects</p> 	N/A	N/A	No surface nor roll defect	0	0.94	B
2	<p>Cut edges</p> 	Machine-cutting e.g. by a thermal process. Sheared edge cutting.	Edges machined or ground	Smooth surface free of cracks and notches	0.1	1.07	B
			No edge treatment	Surface free of cracks and severe notches (inspection procedure)	0.1	1.0	C
		Manually thermally cut e.g. by flame cutting	Surface free of cracks and severe notches (inspection procedure)	0.1	1.24	C	

Note 1: Stress increase due to geometry of cut-outs to be considered.

Table 4 : Non-welded joints: thickness exponent and surface finishing factor

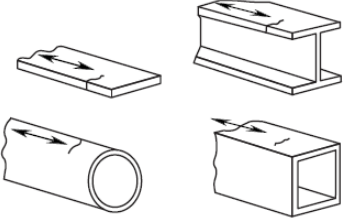
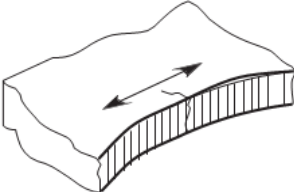
Joint configuration, fatigue crack location and stress direction	Edge cutting process	Edge treatment	Surface finishing	n	K_{sf}	S-N curve
<p>1</p> <p>Rolled or extruded plates and sections as well as seamless pipes, no surface or rolling defects</p> 	N/A	N/A	No surface nor roll defect ^{(1),(2)}	0	0.94	B
<p>2</p> <p>Cut edges</p> 	<p>Machine-cutting e.g. by a thermal process - or sheared edge cutting.</p>	<p><u>Cutting edges chamfered or rounded by means of smooth grinding, groove direction parallel to the loading direction.</u></p>	<p><u>Smooth surface free of cracks and notches.</u> ^{(1),(2)}</p>	<u>0.1</u>	<u>1.00</u>	<u>B</u>
		<p><u>Cutting edges broken or rounded.</u></p>	<p>Smooth surface free of cracks and notches ^{(1),(2)}</p>	0.1	1.07	B
		<p>No edge treatment</p>	<p>Surface free of cracks and severe notches (inspection procedure) ^{(1),(2)}</p>	0.1	1.0	C
	<p>Manually thermally cut e.g. by flame cutting</p>	<p>No edge treatment</p>	<p>Surface free of cracks and severe notches (inspection procedure) ^{(1),(2)}</p>	0.1	1.24	C
<p>Note 1: Stress increase due to geometry of cut-outs to be considered.</p> <p>Note 2: <u>Fine mesh FE analysis according to Sec 5. [2].</u></p>						

SECTION 4 SIMPLIFIED STRESS ANALYSIS

4.1.1 Stress due to dynamic pressure

The hot spot stress, in N/mm², due to local dynamic pressure in load case *i1* and *i2* for loading condition (*j*) is obtained from the following formula:

$$\sigma_{LD, ik(j)} = \frac{K_b K_n S \ell_{bdg}^2 (\eta_W f_{NL} P_{W, ik(j)} + \eta_{ld} P_{ld, ik(j)} + \eta_{bd} P_{bd, ik(j)}) \left(1 - \frac{6x_e}{\ell_{bdg}} + \frac{6x_e^2}{\ell_{bdg}^2}\right)}{12 Z_{eff-n50}}$$

where:

$P_{W, ik(j)}$: Dynamic wave pressure, at the mid span, in kN/m², specified in Ch 4, Sec 5, [1.4], in load case *i1* and *i2* for loading condition (*j*).

$P_{ld, ik(j)}$: Dynamic liquid tank pressure, at the mid span, in kN/m², as specified in Ch 4, Sec 6, [1.1.1], in load case *i1* and *i2* for loading condition (*j*).

Pressure acting on both sides of the stiffener, i.e. applied on the attached plate on stiffener side or on opposite side to the stiffener, could be simultaneously considered if relevant in the loading condition.

For the deck longitudinal stiffeners of bulk carriers, no internal pressure from the topside tank is considered.

(Partial table shown)

Table 4 : Stress concentration factors

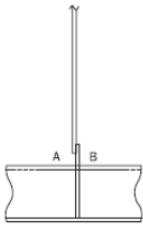
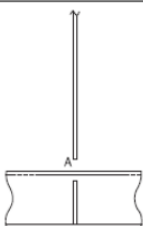
ID	Connection type ⁽²⁾⁽³⁾	Point 'A'		Point 'B'	
		K_a	K_b	K_a	K_b
31 ⁽⁴⁾		1.34 <u>1.13</u>	1.47 <u>1.20</u>	1.34 <u>1.13</u>	1.47 <u>1.20</u>
32 ⁽⁴⁾⁽⁵⁾⁽⁶⁾		1.34 <u>1.13</u>	1.14	N/A	N/A

(2) Where the longitudinal stiffener is a flat bar and there is a web stiffener/bracket welded to the flat bar stiffener, the stress concentration factor listed in the table is to be multiplied by a factor of 1.12 when the thickness of attachment is thicker than the 0.7 times thickness of flat bar stiffener. This also applies to unsymmetrical profiles where there is less than 8 mm clearance between the edge of the stiffener flange and the attachment, e.g. bulb or angle profiles where the clearance of 8 mm cannot be achieved.

5.3 Alternative design

5.3.1

Upon agreement by the Society, the geometrical stress concentration factors for alternative designs are to be calculated by a very fine mesh FE analysis according to the requirements given in Ch 9, Sec 5. Additional requirements for derivation of geometrical stress concentration factors for stiffener end connections using very fine mesh FE analysis are given below:

...

d) FE mesh density: At the location of the hot spots under consideration, the element size is to be in the order of the thickness of the stiffener flange or 10mm depending on the type of stiffener. In the remaining part of the model, the element size is to be in the order of $s/10$, where s is the stiffener spacing.

**Figure 10 : Fine mesh finite element model for derivation of geometrical stress concentration factor
(example of stiffener with flange)**

SECTION 5 FINITE ELEMENT STRESS ANALYSIS

4.2 Calculation of hot spot stress at the flange

4.2.1

For hot spot at the flange of web-stiffened cruciform joints, the surface principal stress is to be read out from a point shifted away from the intersection line between the considered member and abutting member to the position of the actual weld toe and multiplied by 1.12. The intersection line is taken at the mid-thickness of the cruciform joint assuming a median alignment.

The hot spot stress, in N/mm², is to be obtained as:

$$\sigma_{HS} = 1.12 \sigma_{shift}$$

where:

σ_{shift} : Surface principal stress, in N/mm², at shifted stress read out position.

The stress read out point shifted away from the intersection line is obtained as:

$$x_{shift} = \frac{t_{1-n50}}{2} + x_{wt}$$

where:

t_{1-n50} : Net plate thickness of the plate number 1, in mm, as shown in Figure 18

x_{wt} : Extended fillet weld leg length, in mm, as defined in Figure 18, ~~not taken larger than $t_{1-n50}/2$.~~
not taken larger than t_{1-n50}

PART 2 SHIP TYPES

CHAPTER 1 BULK CARRIERS

SECTION 2 STRUCTURAL DESIGN PRINCIPLES

3 STRUCTURAL DETAIL PRINCIPLES

3.3 Deck Structures

3.3.4 Openings in strength deck - Corner of hatchways

a) Within the cargo hold region

For hatchways located within the cargo hold region, insert plates, whose thicknesses are to be determined according to the formula given after, are to be fitted in way of corners where the plating cut-out has a circular profile.

The radius of circular corners is not to be less than 5% of the hatch width, where a continuous longitudinal deck girder is fitted below the hatch coaming.

Corner radius, in the case of the arrangement of two or more hatchways athwartship, is considered by the Society on a case-by-case basis.

For hatchways located within the cargo hold region, insert plates are, in general, not required in way of corners where the plating cut-out has an elliptical or parabolic profile and the half axes of elliptical openings, or the half lengths of the parabolic arch, are not less than:

- 1/20 of the hatchway width or 600 mm, whichever is the lesser, in the transverse direction.
- Twice the transverse dimension, in the fore and aft direction.

Where insert plates are required, their net thickness is to be obtained, in mm, from the following formula:

without being taken less than t_{off} or greater than $1.6 t_{off}$.

$$t_{INS} = \left(0.8 + 0.4 \frac{b}{l} \right) t_{off}$$

where:

- l : Width, in m, in way of the corner considered, of the cross deck strip between two consecutive hatchways, measured in the longitudinal direction, see Pt 1, Ch 3, Sec 6, Figure 15.
- b : Width, in m, of the hatchway considered, measured in the transverse direction, see Pt 1, Ch 3, Sec 6, Figure 15.
- t_{off} : Offered net thickness, in mm, of the deck at the side of the hatchways.

For the extreme corners of end hatchways, insert plates are required. The net thickness of these insert plates is to be 60% greater than the net offered thickness of the adjacent deck plating. A lower thickness may be accepted by the Society on the basis of calculations showing that stresses at hatch corners are lower than permissible values.

Where insert plates are required, the arrangement is shown in Pt 1, Ch 9, Sec 6, Table 15, in which d_1 , d_2 , d_3 and d_4 are to be greater than the stiffener spacing.

For ships having length L of 150 m or above, the corner radius, the thickness and the extent of insert plate may be determined by the results of a direct strength assessment according to Pt 1, Ch 7, including buckling check and fatigue strength assessment of hatch corners according to Pt 1, Ch 8 and Pt 1, Ch 9 respectively. For such type of ships it is recommended to arrange circular hatch corners.

b) Outside the cargo hold region

For hatchways located outside the cargo hold region, a reduction in the thickness of the insert plates in way of corners may be considered by the Society on a case-by-case basis.