

Common Structural Rules for Bulk Carriers and Oil Tankers

Corrigenda 1 to 01 January 2015 version

Note: This Corrigenda enters into force on **1st July 2015**.

Copyright in these Common Structural Rules is owned by each IACS Member as at 1st January 2014.
Copyright © IACS 2014.

The IACS members, their affiliates and subsidiaries and their respective officers, employees or agents (on behalf of whom this disclaimer is given) are, individually and collectively, referred to in this disclaimer as the "IACS Members". The IACS Members assume no responsibility and shall not be liable whether in contract or in tort (including negligence) or otherwise to any person for any liability, or any direct, indirect or consequential loss, damage or expense caused by or arising from the use and/or availability of the information expressly or impliedly given in this document, howsoever provided, including for any inaccuracy or omission in it. For the avoidance of any doubt, this document and the material contained in it are provided as information only and not as advice to be relied upon by any person.

Any dispute concerning the provision of this document or the information contained in it is subject to the exclusive jurisdiction of the English courts and will be governed by English law.

COMMON STRUCTURAL RULES FOR BULK CARRIERS AND OIL TANKERS

CORRIGENDA 1

This document contains editorial amendments or clarifications within the following Parts and Chapters of the Common Structural Rules for Bulk Carriers and Oil Tankers, 01 January 2015. The amendments are effective on 1st July 2015.

The technical background document containing explanation for the editorial amendments in this document can be found in "Technical Background for Corrigenda 1 to 01 January 2015 version".

PART 1

GENERAL HULL REQUIREMENTS

CHAPTER 3

STRUCTURAL DESIGN PRINCIPLES

SECTION 5

LIMIT STATES

3 STRENGTH CHECK AGAINST IMPACT LOADS

3.1 General

3.1.1

Structural response against impact loads such as forward bottom slamming, bow ~~flare slamming~~ impact and grab chocks depends on the loaded area, magnitude of loads and structural grillage.

SECTION 6

STRUCTURAL DETAIL PRINCIPLES

2 GENERAL PRINCIPLES

2.2 Local reinforcements

2.2.1 Reinforcements at knuckles

- a) Knuckles are in general to be stiffened to achieve out-of-plane stiffness by fitting ordinary stiffeners or equivalent means in line with the knuckle.
- b) Whenever a knuckle in a main member (shell, longitudinal bulkhead etc) is arranged, stiffening in the form of webs, brackets or profiles is to be connected to the members to which they are to transfer the load (in shear). See example of reinforcement at upper hopper knuckle in Figure 1.
- c) For longitudinal shallow knuckles, closely spaced carlings are to be fitted across the knuckle, between longitudinal members above and below the knuckle. Carlings or other types of reinforcement need not be fitted in way of shallow knuckles that are not subject to high lateral loads and/or high in-plane loads across the knuckle, such as deck camber knuckles.
- d) Generally, the distance between the knuckle and the support stiffening in line with the knuckle is not to be greater than 50 mm. Otherwise, fatigue analysis according to Ch 9 is to be submitted by the designer.

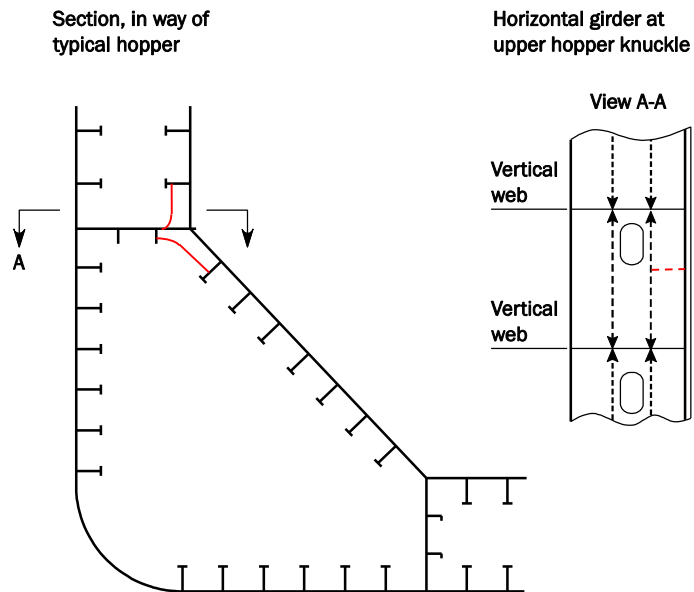
Figure 1 : Example of reinforcement at knuckles

3 STIFFENERS

3.1 GENERAL

3.1.2

Where the angle between the web plate of the stiffener and the attached plating is less than 50 deg as shown on Figure 2, a tripping bracket is to be fitted. If the angle between the web plate of an unsymmetrical stiffener and the attached plating is less than 50 deg, the face plate of the stiffener is to be fitted on the side of open angle.

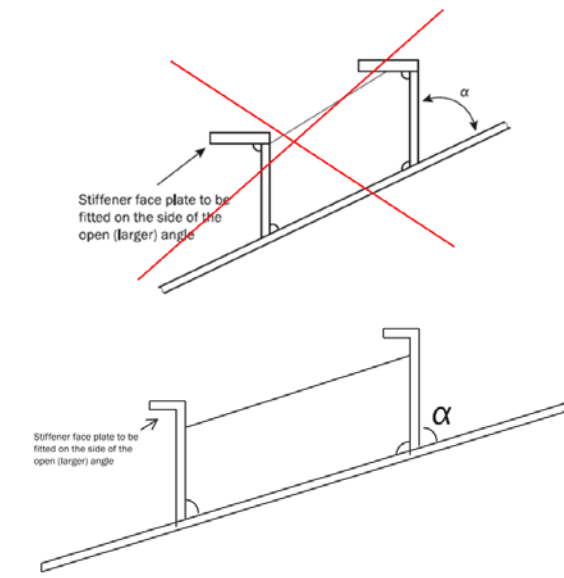
Figure 2 : Stiffener on attached plating with an angle less than 50 deg

3.2 Bracketed end connections of non-continuous stiffeners

3.2.5 Brackets at the ends of non-continuous stiffeners

For connections similar to items (c) and (d) in Figure 3 where the smaller stiffener is connected to a primary supporting member or bulkhead, the bracket arm length is not to be less than **two times of** h_{stf} .

5 INTERSECTION OF STIFFENERS AND PRIMARY SUPPORTING MEMBERS

5.1 Cut-outs

5.1.3

Cut-outs in way of cross tie ends and floors under bulkhead stools or in high stress areas are to be fitted with full collar plates, see Figure 7.

Figure 8 : Symmetric and asymmetric cut-outs

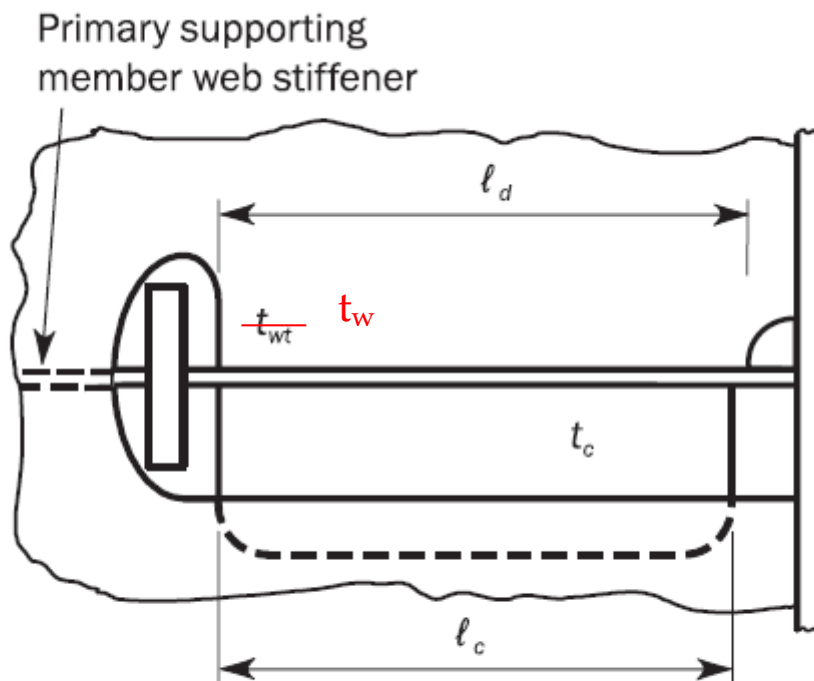

(e) lug or collar plate and direct connection

(part of figure shown only)

Figure 9 : Primary supporting member web stiffener details

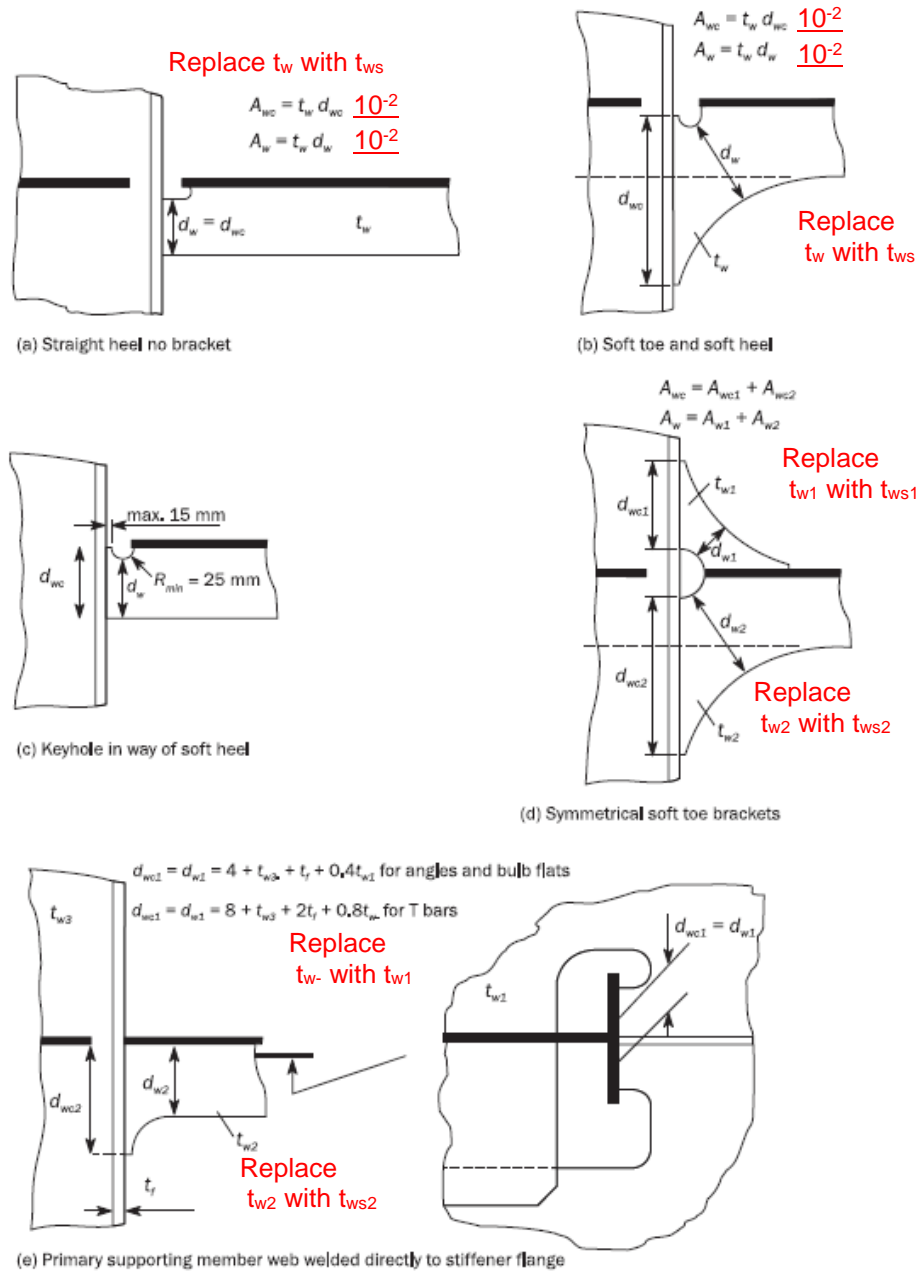

t_{ws} , t_{ws1} , t_{ws2} : Net thickness of the primary supporting member web stiffener/backing bracket, in mm.
 d_w , d_{w1} , d_{w2} : Minimum depth of the primary supporting member web stiffener/backing bracket, in mm.
 d_{wc} , d_{wc1} , d_{wc2} : Length of connection between the primary supporting member web stiffener/backing bracket and the stiffener, in mm.
 t_f : Net thickness of the flange in mm. For bulb profile, t_f is to be obtained as defined in Pt.1 Ch.3 Sec.7 [1.4.1].

5.2 Connection of stiffeners to PSM

5.2.3

The load, W_2 , in kN, transmitted through the PSM web stiffener is to be taken as:

- If the web stiffener is connected to the intersecting stiffener:

$$W_2 = W \left(1 - \alpha_a - \frac{A_1}{4f_c A_w + A_1} \right)$$

- If the web stiffener is not connected to the intersecting stiffener:

$$W_2 = 0$$

The values of A_w , A_{wc} and A_1 are to be such that the calculated stresses satisfy the following criteria:

- For the connection to the PSM web stiffener not in way of the weld: $\sigma_w \leq \sigma_{perm}$
- For the connection to the PSM web stiffener in way of the weld: $\sigma_{wc} \leq \sigma_{perm}$
- For the shear connection to the PSM web: $\tau_w \leq \sigma_{perm}$

where:

W : Load, in kN, as defined in [5.2.2].

f_c : Collar load factor as defined in [5.2.2].

α_a : Panel aspect ratio, as defined in [5.2.2].

A_1 : Effective net shear area, in cm², as defined in [5.2.2].

A_w : Effective net cross sectional area, in cm², as defined in [5.2.2].

σ_w : Direct stress, in N/mm², in the PSM web stiffener at the minimum bracket area away from the weld connection:

$$\sigma_w = \frac{10W_2}{A_w}$$

σ_{wc} : Direct stress, in N/mm², in the PSM web stiffener in way of the weld connection:

$$\sigma_{wc} = \frac{10W_2}{A_{wc}}$$

τ_w : Shear stress, in N/mm², in the shear connection to the PSM web:

~~$$\tau_{wc} = \frac{10W_1}{A_1}$$~~

$$\tau_w = \frac{10W_1}{A_1}$$

A_{wc} : Effective net area, in cm², of the PSM web stiffener in way of the weld as shown in Figure 9.

σ_{perm} : Permissible direct stress given in Table 1 for AC-S and AC-SD, in N/mm².

τ_{perm} : Permissible shear stress given in Table 1 for AC-S and AC-SD, in N/mm².

8 DOUBLE SIDE STRUCTURE

8.1 General

8.1.1

Side shell, and inner hull bulkheads and longitudinal bulkheads are generally to be longitudinally framed. Where the side shell is longitudinally framed, the inner hull bulkheads are to be longitudinally framed. Alternative framing arrangements are to be specially considered by the Society.

SECTION 7 STRUCTURAL IDEALISATION

1 STRUCTURAL IDEALISATION OF STIFFENERS AND PRIMARY SUPPORTING MEMBERS

1.4 Geometrical properties of stiffeners and primary supporting members

1.4.8 Shear area of primary supporting members with web openings

The effective web height, h_{eff} , in mm, to be considered for calculating the effective net shear area, A_{sh-n50} is to be taken as the lesser of:

$$h_{eff} = h_w$$

$$h_{eff} = h_{w3} + h_{w4}$$

$$h_{eff} = h_{w1} + h_{w2} + h_{w4}$$

where:

h_w : Web height of primary supporting member, in mm.

h_{w1} , h_{w2} , h_{w3} , h_{w4} : Dimensions as shown in Figure 16.

Where an opening is located at a distance less than $h_w/3$ from the cross-section considered, h_{eff} is to be taken as the smaller of the net height and the net distance through the opening. See Figure 16.

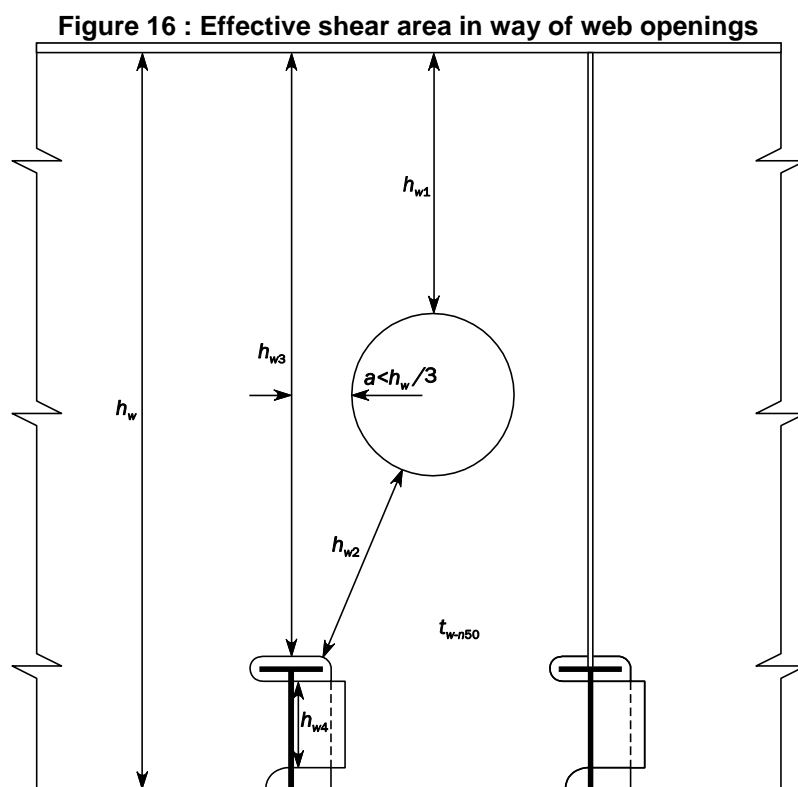

2.2 Load calculation point

2.2.2 Buckling

For the prescriptive buckling check of the EPP according to Ch 8, Sec 3, the LCP for the pressure and for the hull girder stresses are defined in Table 5.

For the FE buckling check, Ch 8, Sec 4 is applicable.

Table 5 : LCP coordinates for plate buckling

LCP coordinates	LCP for pressure	LCP for hull girder stresses (Fig. 23)		
		Bending stresses(1)		Shear stresses
		Non horizontal plate	Horizontal plate	
x coordinate	Same coordinates as LCP for yielding See Table 4	Mid-length of the EPP		
y coordinate		Both upper and lower ends of the EPP (points A1 and A2)	Outboard and inboard ends of the EPP (points A1 and A2)	Mid-point of EPP (point B)
z coordinate		Corresponding to x and y values		

(1) The bending stress for curved plate panel is the mean value of the stresses calculated at points A1 and A2.

LCP coordinates	LCP for pressure	LCP for hull girder stresses (Fig. 23)		
		Bending stresses(1)		Shear stresses
		Non horizontal plate	Horizontal plate	
x coordinate	Same coordinates as LCP for yielding See Table 4	Mid-length of the EPP		
y coordinate		<u>Corresponding to x and z values</u>	Outboard and inboard ends of the EPP (points A1 and A2)	Mid-point of EPP (point B)
z coordinate		<u>Both upper and lower ends of the EPP (points A1 and A2)</u>	Corresponding to x and y values	

(1) The bending stress for curved plate panel is the mean value of the stresses calculated at points A1 and A2.

CHAPTER 4 LOADS

SECTION 6 INTERNAL LOADS

1 PRESSURES DUE TO LIQUIDS

1.2 Static liquid pressure

1.2.2 Harbour/sheltered water operations

The static pressure, P_{ls} due to liquid in tanks and ballast holds for harbour/sheltered water operations, in kN/m^2 , is to be taken as:

$$P_{ls} = \rho_L g(z_{top} - z + h_{air}) + P_{drop} \quad \text{for ballast tanks}$$

$$P_{ls} = \rho_L g(z_{top} - z) + P_{PV} \quad \text{for cargo tanks filled with liquid cargo}$$

$$P_{ls} = \rho_L g(z_{top} - z + 0.5h_{air}) \quad \text{for ballast holds with } h_{air}=0 \text{ and for other cases}$$

5 LOADS ON NON-EXPOSED DECKS AND PLATFORMS

5.3 Concentrated force due to unit load

5.3.1

If a unit load is carried on an internal deck, the static and dynamic forces due to the unit load carried are to be considered when a direct analysis is applied for stiffeners or primary supporting members such as in Pt 1, Ch 6, Sec 5 [1.2] or Pt 1, Ch 6, Sec 6 [3.3] respectively.

SECTION 8

LOADING CONDITIONS

4.2.6 Design load combinations for direct strength analysis

The loading patterns to be considered in the direct strength analysis of bulk carriers are summarised in Table 10. Load combinations providing the calculations details for each loading pattern are given in Table 12 to Table 21.

Table 12 : FE Load combinations applicable to empty hold in alternate condition of BC-A (EA) - midship cargo hold region

No.	Description Reqt ref	Loading pattern	Aft Mid Fore	Draught	C_{BM-LC} : % of perm. SWBM	C_{SF-LC} : % of perm. SWSF	Dynamic load case
Seagoing conditions							
1 ⁽²⁾	Full load [4.1.3]			T_{SC}	50% (sag.)	100%	BSP-1P/S OST-1P/S
20 ⁽¹³⁾	Alt-block harbour condition [4.2.3] item d			T_{H3}	100% (hog.)	100%	N/A
					100% (sag.)	100%	N/A

(1) Loading pattern No. 1 with the cargo mass M_{Full} and the maximum cargo density as defined in [4.1.4] can be analysed in lieu of this loading pattern.

(2) Maximum cargo density as defined in [4.1.4] is to be used for calculation of dry cargo pressure.

(3) In case of no ballast hold, normal ballast condition with assuming $M_{SW} = 100\%$ (hog.) is to be analysed.

(4) Position of ballast hold is to be adjusted as appropriate.

(5) This condition is only required when this loading condition is included in the loading manual.

(6) Actual still water vertical bending moment, as given in the loading manual, may be used instead of design value.

(7) This condition is to be considered for the empty hold which is assigned as ballast hold, if any.

(8) For the mid-hold where $x_{b- aft} < 0.5L$, $x_{b- aft} \leq 0.5L$ and $x_{b- fwd} > 0.5L$, $x_{b- fwd} \geq 0.5L$, the shear force is to be adjusted to target value at aft bulkhead of the mid-hold.

(9) For the mid-hold where $x_{b- aft} < 0.5L$, $x_{b- aft} \leq 0.5L$ and $x_{b- fwd} > 0.5L$, $x_{b- fwd} \geq 0.5L$, the shear force is to be adjusted to target value at forward bulkhead of the mid-hold.

(10) This load combination is to be considered only for the mid-hold where $x_{b- aft} > 0.5L$ or $x_{b- fwd} < 0.5L$.

(11) The shear force is to be adjusted to target value at aft bulkhead of the mid-hold.

(12) The shear force is to be adjusted to target value at forward bulkhead of the mid-hold.

(13) This condition is only required when block loading condition is included in the loading manual.

Table 13 : FE Load combinations applicable to loaded hold in alternate condition of BC-A (FA) - midship cargo hold region

No.	Description Reqt ref	Loading pattern	Aft Mid Fore	Draught	C_{BM-LC} : % of perm. SWBM	C_{SF-LC} : % of perm. SWSF	Dynamic load case
Seagoing conditions							
1 ⁽²⁾	Full load [4.1.3]			T_{SC}	50% (sag.)	100%	BSP-1P/S OST-1P/S
~ ~ ~ ~ ~							
22 ⁽¹³⁾	Alt-block harbour condition [4.2.3] item d			T_{H3}	100% (hog.)	100%	N/A
					100% (sag.)	100%	N/A
<p>(1) Loading pattern no. 1 with the cargo mass M_{Full} and the maximum cargo density as defined in [4.1.4] can be analysed in lieu of this loading pattern.</p> <p>(2) Maximum cargo density as defined in [4.1.4] is to be used for calculation of dry cargo pressure.</p> <p>(3) In case of no ballast hold, normal ballast condition with assuming $M_{SW} = 100\%$ (hog.) is to be analysed.</p> <p>(4) Position of ballast hold is to be adjusted as appropriate.</p> <p>(5) This condition is only required when block loading condition is included in the loading manual.</p> <p>(6) Actual still water vertical bending moment, as given in the loading manual, may be used instead of design value.</p> <p>(7) This condition is to be considered for the heavy cargo hold which is assigned as ballast hold, if any.</p> <p>(8) For the mid-hold where $x_{b-aft} < 0.5L$ $x_{b-aft} \leq 0.5L$ and $x_{b-fwd} > 0.5L$ $x_{b-fwd} \geq 0.5L$, the shear force is to be adjusted to target value at aft bulkhead of the mid-hold.</p> <p>(9) For the mid-hold, where $x_{b-aft} < 0.5L$ $x_{b-aft} \leq 0.5L$ and $x_{b-fwd} > 0.5L$ $x_{b-fwd} \geq 0.5L$, the shear force is to be adjusted to target value at forward bulkhead of the mid-hold.</p> <p>(10) This load combination is to be considered only for the mid-hold, where $x_{b-aft} > 0.5L$ or $x_{b-fwd} < 0.5L$.</p> <p>(11) The shear force is to be adjusted to target value at aft bulkhead of the mid-hold.</p> <p>(12) The shear force is to be adjusted to target value at forward bulkhead of the mid-hold.</p> <p>(13) This condition is only required when block loading condition is included in the loading manual.</p>							

Table 14 : FE Load combinations applicable for BC-B & BC-C - midship cargo hold region

No.	Description Reqt ref	Loading pattern	Aft Mid Fore	Draught	C_{BM-LC} : % of perm. SWBM	C_{SF-LC} : % of perm. SWSF	Dynamic load case
Seagoing conditions							
1 ⁽²⁾⁽³⁾	Full load [4.1.3]			T_{SC}	50% (sag.)	100%	BSP-1P/S OST-1P/S
~~~~~							
16	Harbour condition [4.2.5] items a and b			$T_{H3}$	100% (hog.)	100%	N/A
					100% (sag.)	100%	N/A
<p>(1) Applicable to BC-B only.</p> <p>(2) For BC-B ships, the loading pattern no. 1 with the cargo mass $M_{Full}$ and the maximum cargo density as defined in [4.1.3] can be analysed in lieu of this loading pattern.</p> <p>(3) Maximum cargo density as defined in [4.1.3] is to be used for calculation of dry cargo pressure.</p> <p>(4) In case of no ballast hold, normal ballast condition with assuming $M_{SW} = 100%$ (hog.) is to be analysed.</p> <p>(5) Position of ballast hold is to be adjusted as appropriate.</p> <p>(6) This condition is to be considered for the cargo hold which is assigned as ballast hold, if any.</p> <p>(7) For the mid-hold where <del>$x_{b-aft} &lt; 0.5L$</del> $x_{b-aft} \leq 0.5L$ and <del>$x_{b-fwd} &gt; 0.5L$</del> $x_{b-fwd} \geq 0.5L$, the shear force is to be adjusted to target value at aft bulkhead of the mid-hold.</p> <p>(8) For the mid-hold where <del>$x_{b-aft} &lt; 0.5L$</del> $x_{b-aft} \leq 0.5L$ and <del>$x_{b-fwd} &gt; 0.5L$</del> $x_{b-fwd} \geq 0.5L$, the shear force is to be adjusted to target value at forward bulkhead of the mid-hold.</p> <p>(9) This load combination is to be considered only for the mid-hold where $x_{b-aft} &gt; 0.5L$ or $x_{b-fwd} &lt; 0.5L$.</p> <p>(10) The shear force is to be adjusted to target value at aft bulkhead of the mid-hold.</p> <p>(11) The shear force is to be adjusted to target value at forward bulkhead of the mid-hold.</p>							

## CHAPTER 5 HULL GIRDER STRENGTH

### SECTION 1 HULL GIRDER YIELDING STRENGTH

#### 1 STRENGTH CHARACTERISTICS OF HULL GIRDER TRANSVERSE SECTIONS

##### 1.2 Hull girder transverse sections

###### 1.2.9 Definitions of openings

The following definitions of opening are to be applied:

- a) Large openings are:
  - Elliptical openings exceeding 2.5 m in length or 1.2 m in breadth.
  - Circular openings exceeding 0.9 m in diameter.
- b) Small openings (i.e. **lightening drain holes**, etc) are openings that are not large ones.
- c) Manholes.
- d) Isolated openings are openings spaced not less than 1 m apart in the ship's transverse/vertical direction.

#### 3 HULL GIRDER SHEAR STRENGTH ASSESSMENT

##### 3.5 Effective net thickness for longitudinal bulkheads between cargo tanks of oil tankers - Correction due to loads from transverse bulkhead stringers

###### 3.5.1

In way of transverse bulkhead stringer connections, within areas as specified in Figure 7, the equivalent net thickness of plate,  $t_{sti-k-n50}$  in mm, where the index  $k$  refers to the identification number of the stringer, is not to be taken greater than:

$t_{sti-n50}$ : Effective net plating thickness **as defined in [3.4.1]**, in mm, calculated at the transverse bulkhead for the height corresponding to the level of the stringer.

## APPENDIX 1 DIRECT CALCULATION OF SHEAR FLOW

### 1 CALCULATION FORMULA

#### 1.2 DETERMINATE SHEAR FLOW

##### 1.2.1

The determinate shear flow,  $q_D$  in N/mm, at each location in the cross section can be obtained from the following line integration:

$$q_D(S) = - \frac{1}{10^6 I_{y-n50}} \int_0^S (z - z_n) t_{n50} ds$$

$$q_D(s) = -\frac{1}{10^6 I_{y-n50}} \int_0^s (z - z_n) t_{n50} ds$$

#### 1.2.4

Calculations of the determinate shear flow at bifurcation points can be calculated such as water flow calculations as shown in Figure 3-2.

### 1.4 Computation of several properties of the cross section

#### 1.4.2

The height of horizontal neutral axis,  $z_G$   $z_n$  in m, can be obtained as follows:

$$z_G = \frac{S_{y-n50}}{A_{n50}}$$

$$z_n = \frac{S_{y-n50}}{A_{n50}}$$

## 2 EXAMPLE OF CALCULATIONS FOR A SINGLE SIDE HULL CROSS SECTION

### 2.1 Cross section data

#### 2.1.2

The Z coordinate of horizontal neutral axis and the inertia moment about the neutral axis are calculated as follow:

$$z_G = \frac{\sum s_{y-n50}}{\sum a_{n50}} = \frac{11.686}{1.416} = 8.255$$

$$z_n = \frac{\sum s_{y-n50}}{\sum a_{n50}} = \frac{11.686}{1.416} = 8.255$$

$$I_{y-n50} = 2(\sum i_{y0-n50} - z_n^2 \sum a_{n50}) = 2(185.138 - 8255^2 \times 1.416) = 177.34$$

## APPENDIX 2 HULL GIRDER ULTIMATE CAPACITY

### 2.3 Load-end shortening curves

#### 2.3.1 Stiffened plate element and stiffener element

Stiffened plate element and stiffener element composing the hull girder transverse sections may collapse following one of the modes of failure specified in Table 1.

- Where the plate members are stiffened by non-continuous longitudinal stiffeners, the stress of the element is to be obtained in accordance with [2.3.3] to [2.3.8], taking into account the non-continuous longitudinal stiffener. In calculating the total forces for checking the hull girder ultimate strength, the area of non-continuous longitudinal stiffener is to be assumed as zero.

~~In calculating the total forces for checking the hull girder ultimate strength, the area of non-continuous longitudinal stiffener is to be assumed as zero.~~

- Where the opening is provided in the stiffened plate element, the considered area of the stiffened plate element is to be obtained by deducting the opening area from the plating in calculating the total forces for checking the hull girder ultimate strength. The consideration of the opening is in accordance with the requirement in Ch 5, Sec 1, [1.2.9].
- For stiffened plate element, the effective width of plate for the load shortening portion of the stress-strain curve is to be taken as full plate width, i.e. to the intersection of other plate or longitudinal stiffener – neither from the end of the hard corner element nor from the attached plating of stiffener element, if any. In calculating the total forces for checking the hull girder ultimate strength, the area of the stiffened plate element is to be taken between the hard corner element and the stiffener element or between the hard corner elements, as applicable.



# CHAPTER 6

## HULL LOCAL SCANTLING

### SECTION 4

#### PLATING

## 2 SPECIAL REQUIREMENTS

### 2.2 Bilge plating

#### 2.2.2 Bilge plate thickness ~~within 0.4 L amidships~~

- a) The net thickness of bilge plating is not to be taken less than the offered net thickness for the adjacent bottom shell or adjacent side shell plating, whichever is greater.
- b) The net thickness of ~~curved~~ rounded bilge plating,  $t$ , in mm, is not to be taken less than:

$$t = 6.45 \times 10^{-4} (P_{ex} s_b)^{0.4} R^{0.6}$$

where:

$P_{ex}$  : Design sea pressure for the design load set SEA-1 as defined in Ch 6, Sec 2, [2.1.3] calculated at the lower turn of the bilge, in kN/m².

$R$  : Effective bilge radius in mm.

$$R = R_0 + 0.5 (\Delta s_1 + \Delta s_2)$$

$R_0$  : Radius of curvature, in mm. See Figure 1.

$s_1$  : Distance between the lower turn of bilge and the outermost bottom longitudinal, in mm, see Figure 1. Where the outermost bottom longitudinal is within the curvature, this distance is to be taken as zero.

$\Delta s_2$  : Distance between the upper turn of bilge and the lowest side longitudinal, in mm, see Figure 1. Where the lowest side longitudinal is within the curvature, this distance is to be taken as zero.

$s_b$  : Distance between transverse stiffeners, webs or bilge brackets, in mm.

- c) Longitudinally stiffened bilge plating is to be assessed as regular stiffened plating. The bilge thickness is not to be less than the lesser of the value obtained by [1.1.1] and [2.2.2] b). A bilge keel is not considered as an effective 'longitudinal stiffening' member ~~and unless other longitudinal stiffeners are fitted, this requirement has to be applied.~~

#### ~~2.2.3 Bilge plate thickness outside 0.4 L amidships~~

~~For bilge plating outside 0.4 L amidships, the bilge plate thickness requirement in [2.2.2] is applicable. Special consideration is to be made in evaluation of support provided by the hull form and internal stiffening arrangements. Outside of 0.4 L amidships, the bilge plating thickness and arrangement are to comply with the requirements to side shell or bottom plating in the same region.~~

# CHAPTER 7

## DIRECT STRENGTH ASSESSMENT

### SECTION 2

#### CARGO HOLD STRUCTURAL STRENGTH ANALYSIS

#### 4 LOAD APPLICATION

##### 4.3 Hull girder loads

##### 4.3.3 Target hull girder shear force

The target hull girder vertical shear force at the aft and forward transverse bulkheads of the mid-hold,  $Q_{targ-aft}$  and  $Q_{targ-fwd}$ , in kN, for a given FE load combination is taken as:

- $Q_{fwd} \geq Q_{aft}$ :
 
$$Q_{targ-aft} = C_{SF-LC} \cdot Q_{sw-neg} - \Delta Q_{swa} + f_{\beta} |C_{QW}| Q_{wv-neg}$$

$$Q_{targ-fwd} = C_{SF-LC} \cdot Q_{sw-pos} + \Delta Q_{swf} + f_{\beta} |C_{QW}| Q_{wv-pos}$$
- $Q_{fwd} < Q_{aft}$ :
 
$$Q_{targ-aft} = C_{SF-LC} \cdot Q_{sw-pos} + \Delta Q_{swa} + f_{\beta} |C_{QW}| Q_{wv-pos}$$

$$Q_{targ-fwd} = C_{SF-LC} \cdot Q_{sw-neg} - \Delta Q_{swf} + f_{\beta} |C_{QW}| Q_{wv-neg}$$

where:

$Q_{fwd}$ ,  $Q_{aft}$ : Vertical shear forces, in kN, due to the local loads respectively at the forward and aft bulkhead position of the mid-hold, as defined in [4.4.76].

##### 5.2.7 Exceptions for shear stress correction for openings

...

Table 11 : Exceptions for shear stress correction

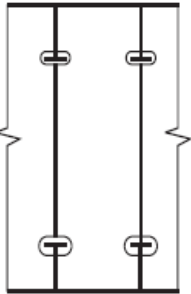
Identification	Figure	Difference between modelled shear area and the net effective shear area in % of the <u>net effective modelled</u> shear area $\frac{A_{FEM-n50} - A_{shr-n50}}{A_{shr-n50}} \cdot 100\%$ $A_{FEM-n50}$	Reduction factor for yield criteria, $C_f$
Upper and lower slots for local support stiffeners fitted with lugs or collar plates		< 15%	0.85

$A_{shr-n50}$  : Effective net shear area of the web, in mm², taken as the web area without the all opening areas and without the slots for stiffeners, in accordance with Ch 3, Sec 7, [1.4.8].

(part of table shown only)

## CHAPTER 8 BUCKLING

### SECTION 3 PRESCRIPTIVE BUCKLING REQUIREMENT

#### 1 GENERAL

##### 1.2 Equivalent plate panel

###### 1.2.1

In longitudinal stiffening arrangement, when the plate thickness varies over the width  $b$ , of a plate panel, the buckling check is to be performed for an equivalent plate panel width, combined with the smaller plate thickness,  $t_1$ . The width of this equivalent plate panel,  $b_{eq}$ , in mm, is defined by the following formula:

$$b_{eq} = \ell_1 + \ell_2 \left( \frac{t_1}{t_2} \right)^{1.5}$$

where:

$\ell_1$  : Width of the part of the plate panel with the smaller **net** plate thickness,  $t_1$ , in mm, as defined in Figure 1.

$\ell_2$  : Width of the part of the plate panel with the greater **net** plate thickness,  $t_2$ , in mm, as defined in Figure 1.

#### 2 HULL GIRDER STRESS

##### 2.1 General

###### 2.1.2

The hull girder shear stresses, N/mm², in the plate  $i$  are determined as follows:

$$\tau_{hg} = \frac{Q_{Tot}(x) q_{vi}}{t_{i-n50}} 10^3$$

where:

$Q_{Tot}(x)$  : Total vertical shear force, in kN, at the ship longitudinal location  $x$ , taken as **the greater of the following values follows:**

## SECTION 4 BUCKLING REQUIREMENTS FOR DIRECT STRENGTH ANALYSIS

### 2 STIFFENED AND UNSTIFFENED PANELS

#### 2.2 Stiffened panels

##### 2.2.2

If the stiffener properties or stiffener spacing varies within the stiffened panel, the calculations are to be performed separately for all configurations of the panels, i.e. for each stiffener and plate between the stiffeners. Plate thickness, stiffener properties and stiffener spacing at the considered location are to be assumed for the whole panel.

Figure 5 : Longitudinal plates for single hull bulk carrier

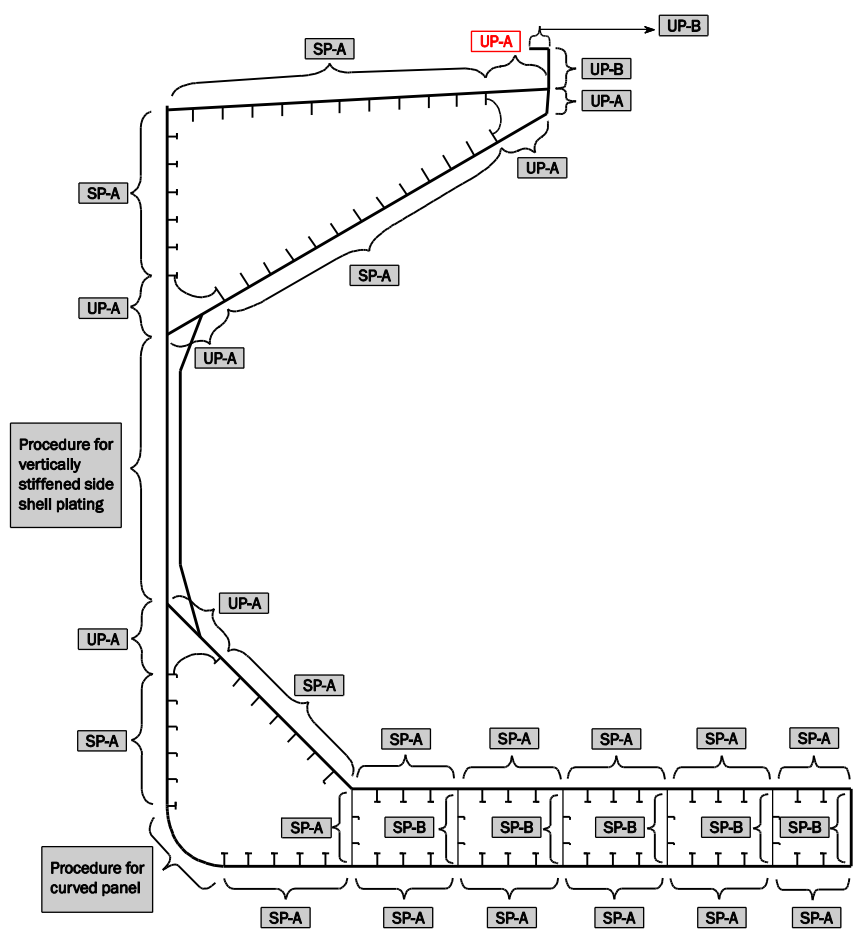
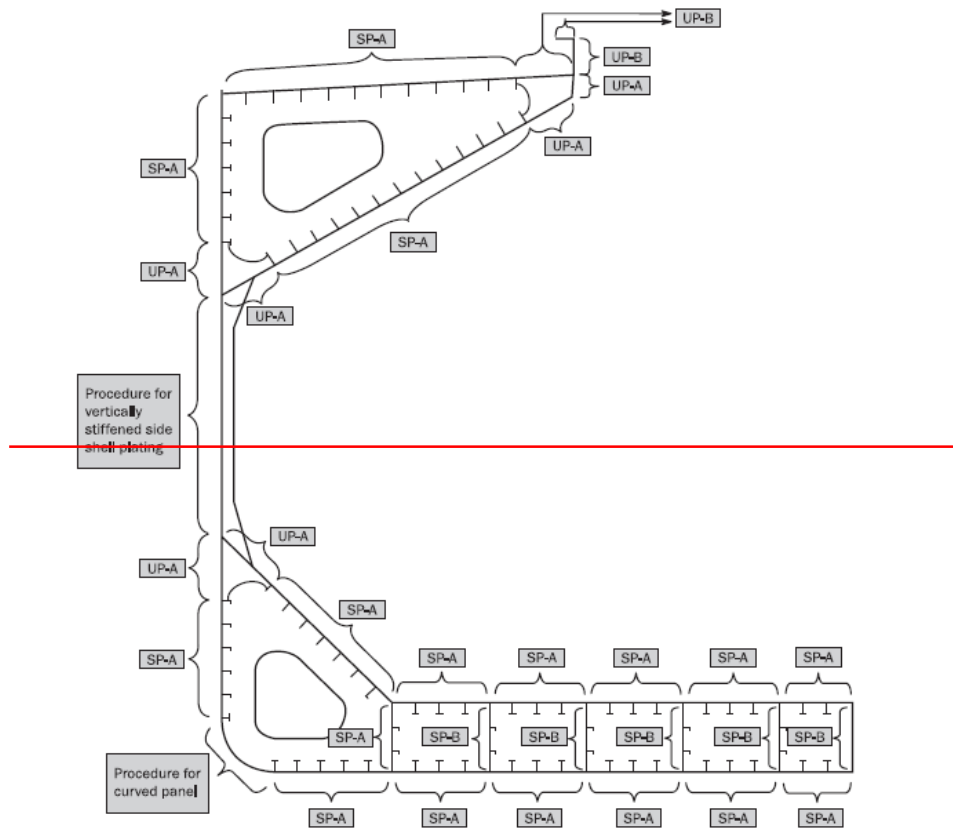
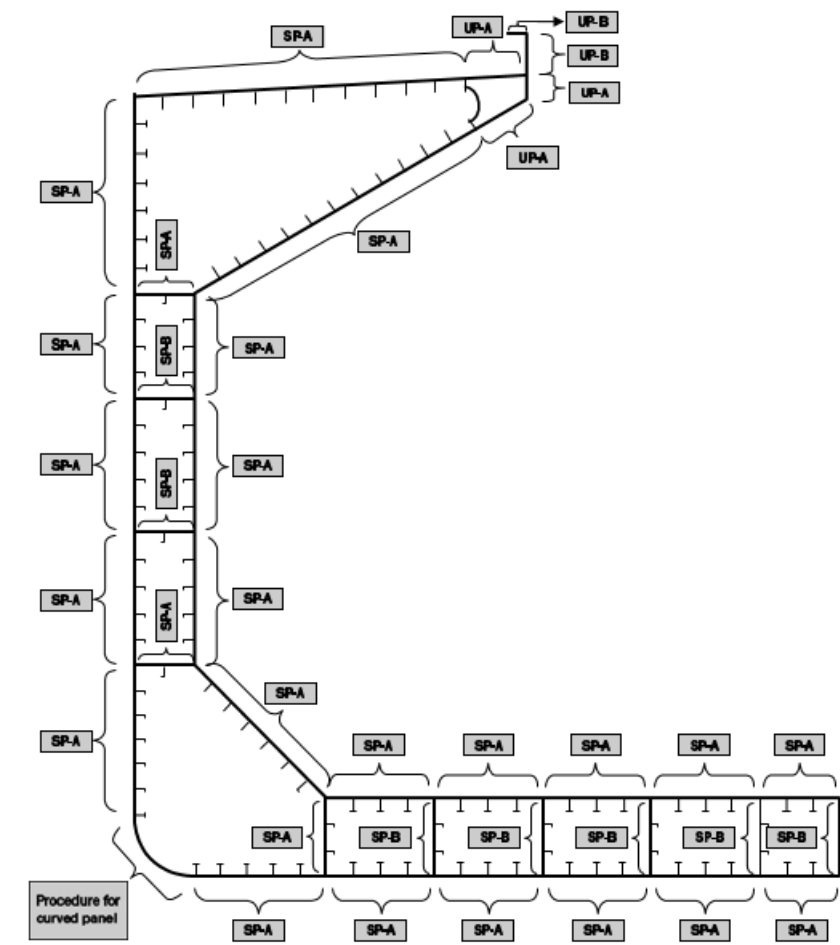
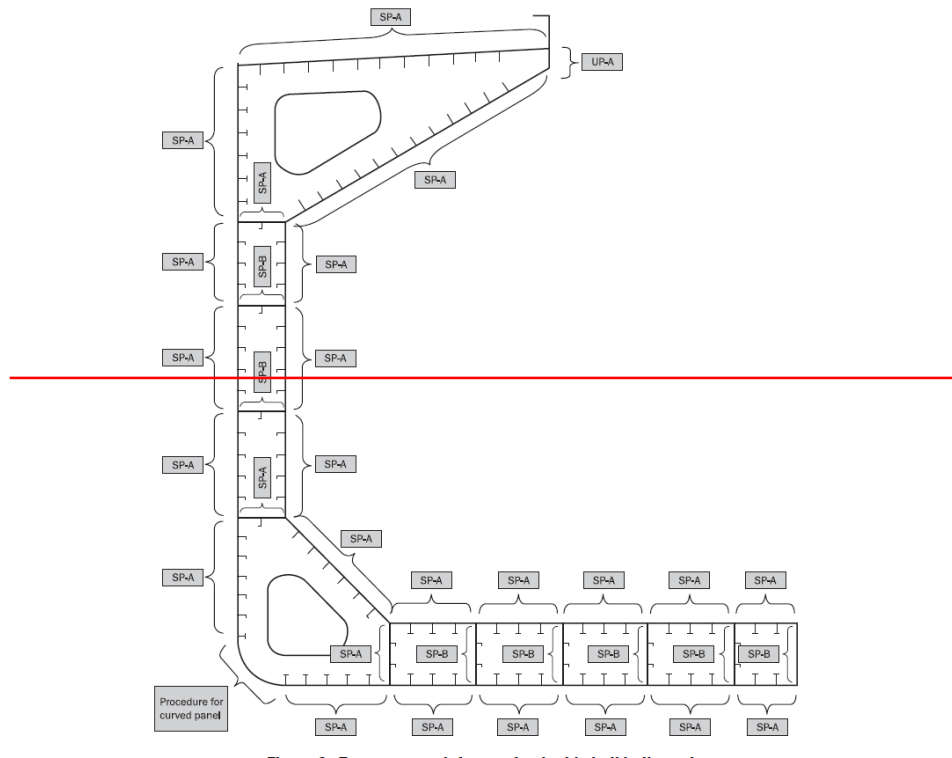

Figure 7 : Longitudinal plates for double hull bulk carrier



## SECTION 5 BUCKLING CAPACITY

### 2 BUCKLING CAPACITY OF PLATES AND STIFFENERS

#### 2.2 Plate capacity

##### 2.2.2 Reference degree of slenderness

The reference degree of slenderness is to be taken as:

$$\lambda = \sqrt{\frac{R_{eH_P}}{K\sigma_E}}$$

where:

K: Buckling factor, as defined in Table 3 and Table 4.

**Table 3 : Buckling factor and reduction factor for plane plate panels**

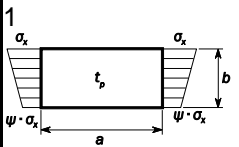
Case	Stress ratio $\psi$	Aspect ratio $\alpha$	Buckling factor $K$	Reduction factor $C$
	$0 \leq \psi \leq 1$		$K_x = F_{long} \frac{8.4}{\psi + 1.1}$	When $\sigma_x \leq 0$ : $C_x = 1$ When $\sigma_x > 0$ : $C_x = 1$ for $\lambda \leq \lambda_c$ $C_x = c \left( \frac{1}{\lambda} - \frac{0.22}{\lambda^2} \right)$ for $\lambda > \lambda_c$ where: $c = (1.25 - 0.12\psi) \leq 1.25$ $\lambda_c = \frac{c}{2} \left( 1 + \sqrt{1 - \frac{0.88}{c}} \right)$
	$0 < \psi < 1$		$K_x = F_{long} [7.63 - \psi(6.26 - 10\psi)]$	
	$\psi \leq -1$		$K_x = F_{long} [5.975(1 - \psi)^2]$	
		$1.5(1 - \psi) \leq \alpha < 3(1 - \psi)$	$f_1 = \frac{1}{\beta} - (2 - \omega\beta)^4 - 9(\omega\beta - 1)\left(\frac{2}{3} - \beta\right)$ $f_2 = f_3 = 0$	

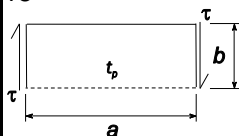
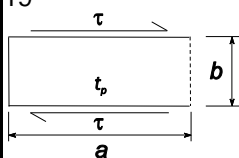
18 	-		<del>$K_\tau = 3^{0.5}(0.6 + 4/\alpha^2)$</del> <u>$K_\tau = \sqrt{3}(0.6 + 4/\alpha^2)$</u>	$C_\tau = 1$ for $\lambda \leq 0.84$
19 	-		$K_\tau = 8$	$C_\tau = \frac{0.84}{\lambda}$ for $\lambda > 0.84$

Edge boundary conditions:  
 - - - - - Plate edge free.  
 ——— Plate edge simply supported.  
 ——— Plate edge clamped.

Note 1: Cases listed are general cases. Each stress component ( $\sigma_x, \sigma_y$ ) is to be understood in local coordinates.

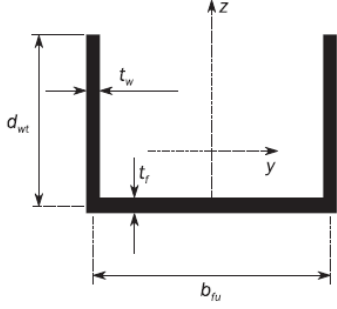

Table 7 : Cross sectional properties

	$I_{sv-n50} = \frac{1}{3} (b_{fu} t_f^3 + 2d_{wt} t_w^3) 10^{-4}$	cm ⁴
	$y_0 = 0$	cm
	$z_0 = -\frac{d_{wt}^2 t_w 10^{-1}}{2d_{wt} t_w b_f t_f} - \frac{0.5d_{wt}^2 t_w 10^{-1}}{d_{wt} t_w + b_{fu} t_f/6}$	cm
	$C_{warp} = \frac{b_{fu}^2 d_{wt}^3 t_w (3d_{wt} t_w + 2b_{fu} t_f)}{12(6d_{wt} t_w + b_{fu} t_f)} 10^{-6}$	cm ⁶

[b_f should be amended to b_{fu}](#)

(part of table shown only)

## CHAPTER 9 FATIGUE

### SECTION 2 STRUCTURAL DETAILS TO BE ASSESSED

#### 2 FINITE ELEMENT ANALYSIS

##### 2.1 Structural details to be assessed

###### 2.1.1 General

Critical structural details to be checked for fatigue by finite element analysis according to Ch 9, Sec 5 are given in [2.1.2] to [2.1.4].

Table 4 to Table 18 give the list of hot spots for structural details.

**Table 16 : Hot spots for connection of longitudinal stiffener and transverse web including cut-outs and lug plates**

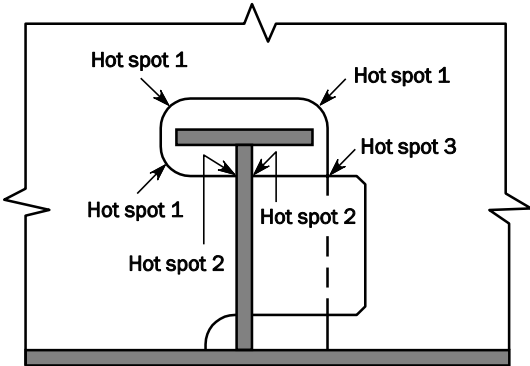
Hot spot location	Procedure for calculation of hot spot stress
The critical hot spot has to be decided for each design in agreement with the Society. Typically the following three hot spot types are to be considered:	
Hot spot 1: Corners of the cut-out edge	<b>Ch 9, Sec 5, [3.42]</b>
Hot spot 2: Connection of transverse web/lug-plate to longitudinal stiffener web in way of slot Hot spot 3: Overlapping connection between transverse web and lug plate	<b>Ch 9, Sec 5, [3.1], type "b"</b>
	

## SECTION 3 FATIGUE EVALUATION

### 3 REFERENCE STRESSES FOR FATIGUE ASSESSMENT

#### 3.1 Fatigue stress range

##### 3.1.3 Base material free edge

For base material free edge, the fatigue stress range,  $\Delta\sigma_{FS,i(j)}$  in N/mm², is taken as the local stress range at free edge,  $\Delta\sigma_{BS,i(j)}$ , as defined in Ch 9, Sec 1, [2.4] with correction factors:

$$\Delta\sigma_{FS,i(j)} = K_{sf} \cdot f_{material} \cdot f_{mean,i(j)} \cdot f_{thick} \cdot \underline{f_c} \cdot \Delta\sigma_{BS,i(j)}$$

where:

$K_{sf}$  : Surface finishing factor for base material given in [4.2.3].

$f_{material}$  : Correction factor for material strength, taken as:

$$f_{material} = \frac{1200}{965 + R_{eH}}$$

$\Delta\sigma_{BS,i(j)}$  : Local stress range, in N/mm², due to dynamic loads in load case (*i*) of loading condition (*j*) taken as:

$$\Delta\sigma_{BS,i(j)} = |\sigma_{BS,i1(j)} - \sigma_{BS,i2(j)}|$$

$\sigma_{BS,i1(j)}$ ,  $\sigma_{BS,i2(j)}$  : Local stress, in N/mm², in load case 'i1' and 'i2' of loading condition (*j*), obtained by very fine mesh FE analysis specified in Ch 9, Sec 5.

## 4 S-N CURVES

#### 4.1 Basic S-N curves

##### 4.1.4 In-air environment

The basic design curves in-air environment shown in Figure 3 are represented by linear relationships between

$\log(\Delta\sigma)$  and  $\log(N)$  as follows :

$$\log(N) = \log(K_2) - m \cdot \log(\Delta\sigma)$$

where:

~~$$\log(K_2) = \log(K_1) - 2\delta$$~~

$$\log(K_2) = \log(K_1) - 2 \cdot \log(\delta)$$

## SECTION 4 SIMPLIFIED STRESS ANALYSIS

### 4 LOCAL STIFFENER STRESS

#### 4.2 Stress due to relative displacement

##### 4.2.4 Oil tankers

The additional hot spot stress due to relative displacement for load case  $i1$  and  $i2$  of loading condition ( $j$ ) for an oil tanker is to be accounted for either using finite element method as described in [4.2.6] or by applying a stress factor on the local dynamic stress component as described in the following:

~~$$\sigma_{dD-ik(j)} = (K_d - 1) \cdot \sigma_{LD-ik(j)}$$~~

$$\sigma_{dD-ik(j)} = (K_d - 1) \cdot \sigma_{LD-ik(j)}$$

where:

$\sigma_{LD-ik(j)}$  : Local dynamic stress defined in [4.1.1].

$K_d$  : Bending stress factor for longitudinal stiffeners caused by relative displacement between supports, shown on Figure 3, as given in Table 2.

#### 4.2.6 Stress due to relative displacement derived using FE method

Additional stress at location 'a' and 'f', in  $N/mm^2$ , due to the relative displacement between the transverse bulkhead including swash bulkhead or floors in way of stool and the forward (Fwd) and afterward (Aft) transverse web or floor respectively for load case  $i1$  and  $i2$  of loading condition ( $j$ ), taken as:

$$\sigma_{dFwd-a,ik(j)} = \frac{3.9\delta_{Fwd,ik(j)}EI_{Aft-n50}I_{Fwd-n50}}{Z_{Aft-n50}\ell_{Fwd}(\ell_{Aft}I_{Fwd-n50} + \ell_{Fwd}I_{Aft-n50})} \left( 1 - 1.15 \frac{|x_{eAft}|}{\ell_{Aft}} \right) 10^{-5}$$

$$\sigma_{dAft-a,ik(j)} = \left[ \frac{3.9\delta_{Aft,ik(j)}EI_{Aft-n50}I_{Fwd-n50}}{Z_{Aft-n50}\ell_{Aft}(\ell_{Aft}I_{Fwd-n50} + \ell_{Fwd}I_{Aft-n50})} \left( 1 - 1.15 \frac{|x_{eAft}|}{\ell_{Aft}} \right) - \frac{0.9\delta_{Aft,ik(j)}EI_{Aft-n50}|x_{eAft}|}{Z_{Aft-n50}\ell_{Aft}^3} \right] 10^{-5}$$

~~$$\sigma_{dFwd-f,ik(j)} = \left[ \frac{3.9\delta_{Fwd,ik(j)}EI_{Aft-n50}I_{Fwd-n50}}{Z_{Fwd-n50}\ell_{Fwd}(\ell_{Aft}I_{Fwd} + \ell_{Fwd}I_{Aft-n50})} \left( 1 - 1.15 \frac{|x_{eFwd}|}{\ell_{Fwd}} \right) - \frac{0.9\delta_{Fwd,ik(j)}EI_{Fwd-n50}|x_{eFwd}|}{Z_{Fwd-n50}\ell_{Fwd}^3} \right] 10^{-5}$$~~

$$\sigma_{dFwd-f,ik(j)} = \left[ \frac{3.9\delta_{Fwd,ik(j)}EI_{Aft-n50}I_{Fwd-n50}}{Z_{Fwd-n50}\ell_{Fwd}(\ell_{Aft}I_{Fwd-n50} + \ell_{Fwd}I_{Aft-n50})} \left( 1 - 1.15 \frac{|x_{eFwd}|}{\ell_{Fwd}} \right) - \frac{0.9\delta_{Fwd,ik(j)}EI_{Fwd-n50}|x_{eFwd}|}{Z_{Fwd-n50}\ell_{Fwd}^3} \right] 10^{-5}$$

$$\sigma_{dAft-f,ik(j)} = \frac{3.9\delta_{Aft,ik(j)}EI_{Aft-n50}I_{Fwd-n50}}{Z_{Fwd-n50}\ell_{Aft}(\ell_{Aft}I_{Fwd-n50} + \ell_{Fwd}I_{Aft-n50})} \left( 1 - 1.15 \frac{|x_{eFwd}|}{\ell_{Fwd}} \right) 10^{-5}$$

Figure 4 : Definition of the relative displacement (example of the side longitudinal)

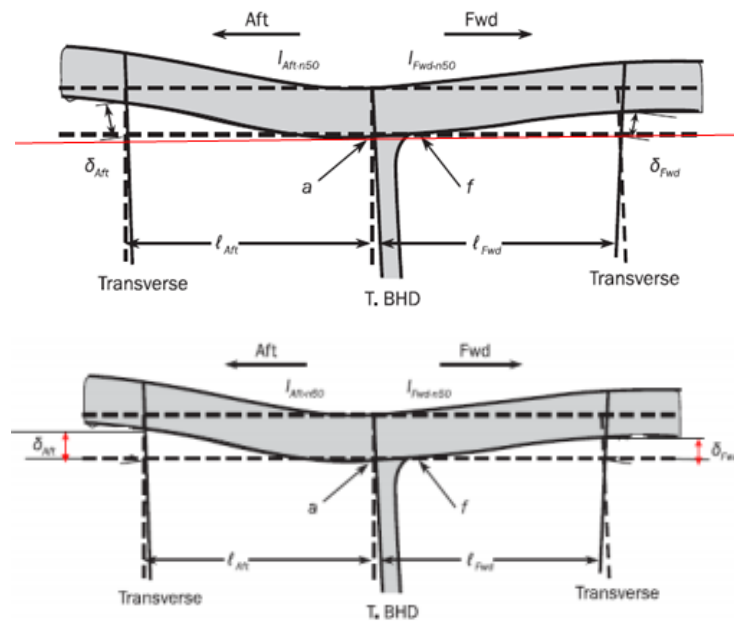

## 5 STRESS CONCENTRATION FACTORS

### 5.2 Longitudinal stiffener end connections

#### 5.2.6 Recommended detail designs

**Table 4 : Stress concentration factors**

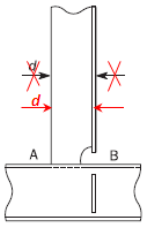
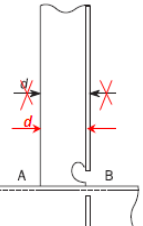
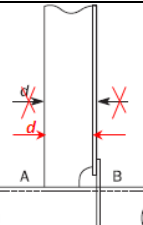
ID	Connection type ^{(2) (3)}	Point 'A'		Point 'B'	
		$K_a$	$K_b$	$K_a$	$K_b$
1 ⁽¹⁾		1.28 for $d \leq 150$ 1.36 for $150 < d \leq 250$ 1.45 for $d > 250$	1.40 for $d \leq 150$ 1.50 for $150 < d \leq 250$ 1.60 for $d > 250$	1.28 for $d \leq 150$ 1.36 for $150 < d \leq 250$ 1.45 for $d > 250$	1.60
2 ⁽¹⁾		1.28 for $d \leq 150$ 1.36 for $150 < d \leq 250$ 1.45 for $d > 250$	1.40 for $d \leq 150$ 1.50 for $150 < d \leq 250$ 1.60 for $d > 250$	1.14 for $d \leq 150$ 1.24 for $150 < d \leq 250$ 1.34 for $d > 250$	1.27
25 ⁽¹⁾		1.28 for $d \leq 150$ 1.36 for $150 < d \leq 250$ 1.45 for $d > 250$	1.40 for $d \leq 150$ 1.50 for $150 < d \leq 250$ 1.60 for $d > 250$	1.14 for $d \leq 150$ 1.24 for $150 < d \leq 250$ 1.34 for $d > 250$	1.25 for $d \leq 150$ 1.36 for $150 < d \leq 250$ 1.47 for $d > 250$

### 5.3 Alternative design

#### 5.3.1 [Derivation of alternative stress concentration factors](#)

## SECTION 5 FINITE ELEMENT STRESS ANALYSIS

### 3 HOT SPOT STRESS FOR DETAILS DIFFERENT FROM WEB-STIFFENED CRUCIFORM JOINTS

#### 3.3 Bent hopper knuckle

##### 3.3.2

The procedure for calculation of hot spot stress at flange such as inner bottom /hopper sloping plate is the same that for web-stiffened cruciform joints as described in [4.2.1]. The procedure that applies for hot spots on the ballast tank side of the inner bottom/hopper plate in way of a bent hopper knuckle is in [principal principle](#) the same as that applied on the cargo tank side of the inner bottom plate for welded knuckle in Figure 18 and Figure 19. The intersection line is taken at the mid-thickness of the joint assuming median alignment. The plate angle correction factor and the reduction of bending stress as applied for a web-stiffened cruciform joint in [4.2.2] are not to be applied for the bent hopper knuckle type.

## SECTION 6 DETAIL DESIGN STANDARD

### 2 STIFFENER-FRAME CONNECTIONS

#### 2.2 Equivalent design of stiffener-frame connections

##### 2.2.3

The very fine mesh finite element models are made to analyse the behaviour in way of double side or double bottom. The models should have an extent of 3 stiffeners in cross section, i.e. 4 stiffener spacings, and the longitudinal extent is to be one half frame spacing in both forward and aft direction. A typical model is shown in Figure 1. No cut-outs for access openings are to be included in the models. Connection between the lug or the web-frame to the longitudinal stiffener web, connections of the lug to the web-frame and free edges on lugs and cut-outs in web-frame are to be modelled with elements of net plate thickness size ( $t_{n50} \times t_{n50}$ ). The mesh with net plate thickness size should extend at least five elements in all directions. Outside this area, the mesh size may gradually be increased in accordance with the requirements in Ch 9, Sec 5, [2]. The eccentricity of the lapped lug plates is to be included in the model. Transverse web and lug plates are to be connected by eccentricity elements (transverse plate elements). The height of eccentricity element is to be the distance between mid-layers of transverse web and lug plates having a thickness equal to 2 times the net thickness of web-frame plate  $t_{w-n50}$ . Eccentricity elements representing fillet welds are shown in Figure 2.

**Figure 2 : Modelling of eccentric lug plate by shell elements**

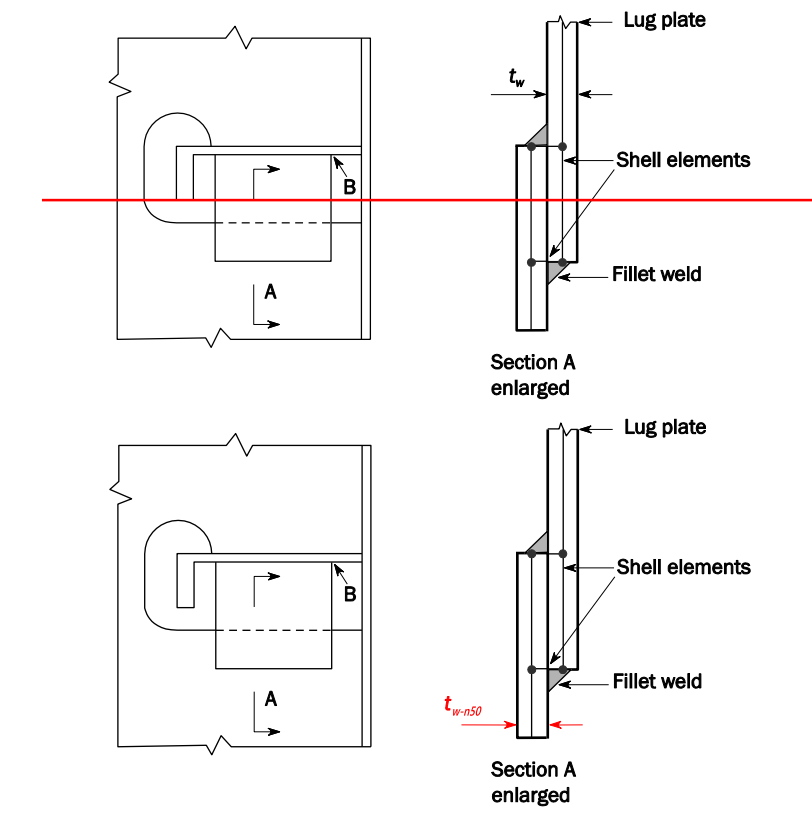

## 6 BULKHEAD CONNECTION TO LOWER AND UPPER STOOL

### 6.1 Design standard J, K and L

#### 6.1.2

The welded connection of bulkhead to upper stool of bulk carriers are to be designed according to the design standard ~~M-L~~, as shown in Table 12.

**Table 10 : Design standard J – transverse bulkhead connection detail, bulk carrier (Ballast hold)**

Connections of transverse bulkhead with lower stool	
Critical areas	Design standard J
Building tolerances	Ensure alignment between lower stool sloping plates and corrugation faces according to <i>IACS Recommendation No. 47</i> .
Welding requirement	<p>Full penetration welding is to be applied between lower stool top plates and the side plating of lower stools and corrugated bulkheads.</p> <p>Partial or full penetration welding is to be applied around gusset plates. However, full penetration welding is to be applied between lower stool top plates and gusset plates.</p> <p><del>Partial or full penetration welding is to be applied between lower stool top plates and diaphragms/web rings.</del></p> <p>Ensure start and stop of welding is as far away as practicable from the critical corners.</p>

**Table 12 : Design standard L – transverse bulkhead connection detail, bulk carrier (Ballast hold)**

Connections of transverse bulkhead with sloped plate of upper stool	
Critical areas	Design standard L
Building tolerances	Ensure alignment between the face plates of corrugated bulkheads with the stool side plates as well as the watertight bulkheads and deep transverse web (or well-stiffened backing stiffener) in the topside tanks according to <i>IACS Recommendation No. 47</i> .
Welding requirement	<p><del>In the case of ballast holds:</del></p> <ul style="list-style-type: none"> <li>· Partial or full penetration welding is to be applied between upper stool bottom plates and corrugation.</li> <li>· Fillet welding having minimum weld factor of 0.44 is to be applied between upper stool bottom plates and upper stool side plating.</li> <li>· Fillet welding having minimum weld factor of 0.44 is to be applied between upper stool bottom plates and diaphragms/web rings.</li> </ul> <p>Ensure start and stop of welding is as far away as practicable from the critical corners in all holds.</p>

# CHAPTER 10

## OTHER STRUCTURES

### SECTION 1

#### FORE PART

### 3 STRUCTURE SUBJECTED TO IMPACT LOADS

#### 3.3 Bow impact

##### 3.3.4 Side shell stiffeners

The side shell stiffeners within the strengthening area defined in [3.3.1] are to comply with the following criteria:

- a) The effective net plastic section modulus,  $Z_{pl}$ , in  $\text{cm}^3$  in association with the effective plating to which it is attached, is not to be less than:

$$Z_{pl} = \frac{P_{FB} s \ell_{bdg}^2}{f_{bdg} C_s R_{eH}}$$

where:

$C_s$  : Permissible bending stress coefficient taken as:

$$C_s = 0.9 \text{ for acceptance criteria set AC-I.}$$

- b) The net web thickness,  $t_w$ , in mm, is not to be less than:

$$t_w = \frac{P_{FB} s \ell_{shr}}{2d_{shr} C_t \tau_{eH}}$$

where:

$d_{shr}$  : Effective web depth of stiffener, in mm, as defined in Ch 3, Sec 7, [1.4.3].

$C_t$  : Permissible shear stress coefficient taken as:

$$C_t = 1.0 \text{ for acceptance criteria set AC-I.}$$

- c) The slenderness ratio is to comply with Ch 8, Sec 2.

~~d) The minimum net thickness of breasthooks/diaphragm plates,  $t_w$ , in mm, is not to be less than:~~

~~$$t_w = \frac{s}{70} \sqrt{\frac{R_{eH}}{235}}$$~~

~~where:~~

~~$s$  : Spacing of stiffeners on the web, as defined in Ch 1, Sec 4, Table 5, in mm. Where no stiffeners are fitted,  $s$  is to be taken as the depth of the web.~~

##### 3.3.6 Primary supporting members

- g) The net web thickness of each primary supporting member,  $t_w$ , in mm including decks/bulkheads in way of the side shell is not to be less than:

$$t_w = \frac{P_{FB} b_{BI}}{\sin \varphi_W \sigma_{crb}}$$

where:

$\varphi_W$  : Angle, in deg, between the primary supporting member web and the shell plate, see Figure 5.

~~$\sigma_{cr}$~~   $\sigma_{crb}$  : Critical buckling stress in compression of the web of the primary supporting member or deck/bulkhead panel in way of the applied load given by Ch 8, Sec 5, [3.1.1], in  $\text{N/mm}^2$



## SECTION 4

### TANKS SUBJECT TO SLOSHING

#### SYMBOLS

For symbols not defined in this section, refer to Ch 1, Sec 4.

$\alpha_p$  : Correction factor for the panel aspect ratio to be taken as:

$$\alpha_p = 1.2 - \frac{b}{2.1a} \text{ but not to be taken as greater than 1.0.}$$

$a$  : Length of plate panel, in mm, as defined in Ch 3, Sec 7, [2.2.2 2.1.1].

$b$  : Breadth of plate panel, in mm, as defined in Ch 3, Sec 7, [2.2.2 2.1.1].

$\ell_{bdg}$  : Effective bending span, as defined in Ch 3, Sec 7, 1.1.2, in m.

$\ell_{slh}$  : Effective sloshing length, in m, as defined in Ch 4, Sec 6, [6.3.2].

$b_{slh}$  : Effective sloshing breadth, in m, as defined in Ch 4, Sec 6, [6.4.2].

$I_{y-n50}$  : Net horizontal hull girder moment of inertia, at the longitudinal position being considered, as defined in Ch 5, Sec 1, [1.5], in m⁴.

$M_{sw}$  : Permissible hull girder hogging and sagging still water bending moment for seagoing operation at the location being considered, in kNm, as defined in Ch 4, Sec 4, [2.2.2].

$z_n$  : Distance from the baseline to the horizontal neutral axis, as defined in Ch 5, Sec 1, in m.

$z$  : Vertical coordinate of the load calculation point or at the reference point under consideration, in m.

$\sigma_{hg}$  : Hull girder bending stress, in N/mm², calculated at the load calculation point defined in Ch 3, Sec 7, [2.2] or in Ch 3, Sec 7, [3.2], as the case may be:

## CHAPTER 12 OTHER STRUCTURES

### SECTION 3 DESIGN OF WELD JOINTS

#### 2.3 Intermittent fillet welds

##### 2.3.4 Size for one side continuous weld

The size for one side continuous weld is to be of fillet required by [2.5.2] for intermittent welding, where  $f_2 f_3$  factor is to be taken as 2.0.

## PART 2 SHIP TYPES

### CHAPTER 1 BULK CARRIERS

#### SECTION 3 HULL LOCAL SCANTLING

##### 1 CARGO HOLD SIDE FRAMES OF SINGLE SIDE BULK CARRIERS

##### 1.2 Lower bracket of side frame

##### 1.2.4

The net thickness  $t_{LB}$  of the lower bracket is to comply with the following formula:

- For symmetrically flanged frames:

$$\frac{h_{LB}}{t_{LB}} \leq 87\sqrt{k}$$

- For asymmetrically flanged frames:

$$\frac{h_{LB}}{t_{LB}} \leq 73\sqrt{k}$$

The web depth  $h_{LB}$  of lower bracket is to be measured from the intersection between the hopper tank sloping plating and the side shell plate, perpendicularly to the face plate of the lower bracket as shown in Ch 1, Sec 2, Figure 5.

For the three side frames located immediately abaft the collision bulkhead, where the frames are strengthened in accordance with [4.1.2 1.1.3] and the offered  $t_{LB}$  is greater than  $1.73 t_w$ , the  $t_{LB}$  applied in [1.2.4] may be taken as  $t'_{LB}$  given by:

$$t'_{LB} = (t_{LB}^2 t_w)^{1/3}$$

where  $t_w$  is the net thickness of the side frame web, in mm, corresponding to  $A_{shr}$  determined in accordance to [1.1.1].

#### 4 ALLOWABLE HOLD LOADING FOR BC-A & BC-B SHIPS IN FLOODED CONDITIONS

##### 4.1 Evaluation of double bottom capacity and allowable hold loading

##### 4.1.3 Girder shear strength

...

$\tau_A$  : Allowable shear stress, in N/mm², as defined in [4.1.2] where  $t$  is the girder web net thickness.

##### 4.1.4 Allowable hold loading

The allowable hold loading, in t, is to be taken as:

$$W = \rho_c V \frac{1}{F}$$

- For steel mill products:

$$P = \frac{Z + \rho g(z_F - 0.1D_1 - h_F)}{1 - \frac{\rho}{\rho_c}}$$

$$P = \frac{Z + \rho g(z_F - 0.1D_1 - h_F)}{1 - \frac{\rho}{\rho_{st}}}$$

$\rho_{st}$  : Density of steel, in t/m³, to be taken as 7.8.

## SECTION 5 CARGO HATCH COVERS

### 5 STRENGTH CHECK

#### 5.4 Primary supporting members

##### 5.4.6 Buckling strength of the web panels of the primary supporting members

The web of primary supporting members subject to loading conditions as defined in [4.1] is to be taken as:

$$\eta_{Plate} \leq \eta_{all}$$

where:

$\eta_{Plate}$  : Maximum plate utilisation factor calculated according to Method A, as defined in Pt 1, Ch 8, Sec 5,[2.4-2]. For web plate in way of opening, it is to be calculated according to Method A, as defined in Pt 1, Ch 8, Sec 5, [2.4].

#### 5.5 Stiffeners and primary supporting members of variable cross section

##### 5.5.1

...

~~$$Z = X_{CS}$$~~

~~$$Z = Z_{CS}$$~~

...

## 6 HATCH COAMINGS

### 6.2 Load model

#### 6.2.4

For cargo holds intended for the carriage of ~~liquid cargoes~~ ballast water, the liquid internal pressures applied on hatch coaming is also to be determined according to Pt 1, Ch 4, Sec 6.

## CHAPTER 2 OIL TANKERS

### SECTION 3 HULL LOCAL SCANTLING

#### 2 VERTICALLY CORRUGATED BULKHEADS

##### 2.2 Scantling requirements

##### 2.2.2 Net web plating thickness over the height

...

$P_l$  : Design pressure given in [Table 4 Pt 1, Ch 6, Sec 2, Table 1](#) for the design load set being considered, calculated at the lower end of the corrugation, in kN/m².

$P_u$  : Design pressures given in [Table 4 Pt 1, Ch 6, Sec 2, Table 1](#) for the design load set being considered, calculated at the upper end of the corrugation, in kN/m².

##### 2.2.4 Net section modulus over the height

...

$P_l, P_u$  : Design pressure given in [Table 4 Pt 1, Ch 6, Sec 2, Table 1](#) for the design load set being considered, calculated at the lower and upper ends of the corrugation, in kN/m².

...

$l_0$  : Effective bending span of the corrugation, in m, measured from the mid depth of the lower stool to the mid depth of the upper stool. Where no lower or upper stool is fitted,  $l_0$  is to be measured to lower or upper end. See Figure 4.

...

$C_1$  : Coefficient taken as:

$$C_1 = a_1 - b_1 \sqrt{\frac{A_{dt}}{b_{dk}}} \text{ for transverse bulkhead with no lower stool, but taken not less than 0.55.}$$

**Figure 4 : Definition of parameters for corrugated bulkhead (Tankers with longitudinal bulkhead at centreline)**

