

No.95 Recommendation for the Application of SOLAS Regulation V/15

(Oct 2007)

(Corr.1

Mar 2009)

(Corr.2

July 2011)

Bridge Design, Equipment Arrangement and Procedures (BDEAP)

Foreword

This Recommendation sets forth a set of guidelines for determining compliance with the principles and aims of SOLAS regulation V/15 relating to bridge design, design and arrangement of navigational systems and equipment and bridge procedures when applying the requirements of SOLAS regulations V/19, 22, 24, 25, 27 and 28 at the time of delivery of the newbuilding.

The development of this Recommendation has been based on the international regulatory regime and IMO instruments and standards already accepted and referred to by IMO. The platform for the Recommendation is:

- the aims specified in SOLAS regulation V/15 for application of SOLAS regulations V/19, 22, 24, 25, 27 and 28
- the content of SOLAS regulations V/19, 22, 24, 25, 27, 28
- applicable parts of MSC/Circ.982, “Guidelines on ergonomic criteria for bridge equipment and layout”
- applicable parts of IMO resolutions and performance standards referred to in SOLAS
- applicable parts of ISO and IEC standards referred to for information in MSC/Circ.982
- STCW Code
- ISM Code

This Recommendation is developed to serve as a self-contained document for the understanding and application of the requirements, supported by:

- Annex A giving guidance and examples on how the requirements set forth may be met by acceptable technical solutions. The guidance is not regarded mandatory in relation to the requirements and does not in any way exclude alternative solutions that may fulfil the purpose of the requirements.
 - Appendix 1 to Annex A, “Tasks and related means – Examples of location of main equipment”
- Annex B “Facts and principles – Related to SOLAS V/15 and the IACS Recommendation” that should assist in achieving a common understanding of the content of SOLAS regulation 15 and the approach and framework of the Recommendation.
 - Appendix 1 to Annex B clarifying the content of each aim of SOLAS regulation V/15.

Chapter C 2 “Bridge alarm management” is established by compilation of relevant IMO and classification requirements and guidelines. The chapter is recommended for compliance until superseded by an IMO performance standard.

The diagram following this foreword gives an overview of approach and content.

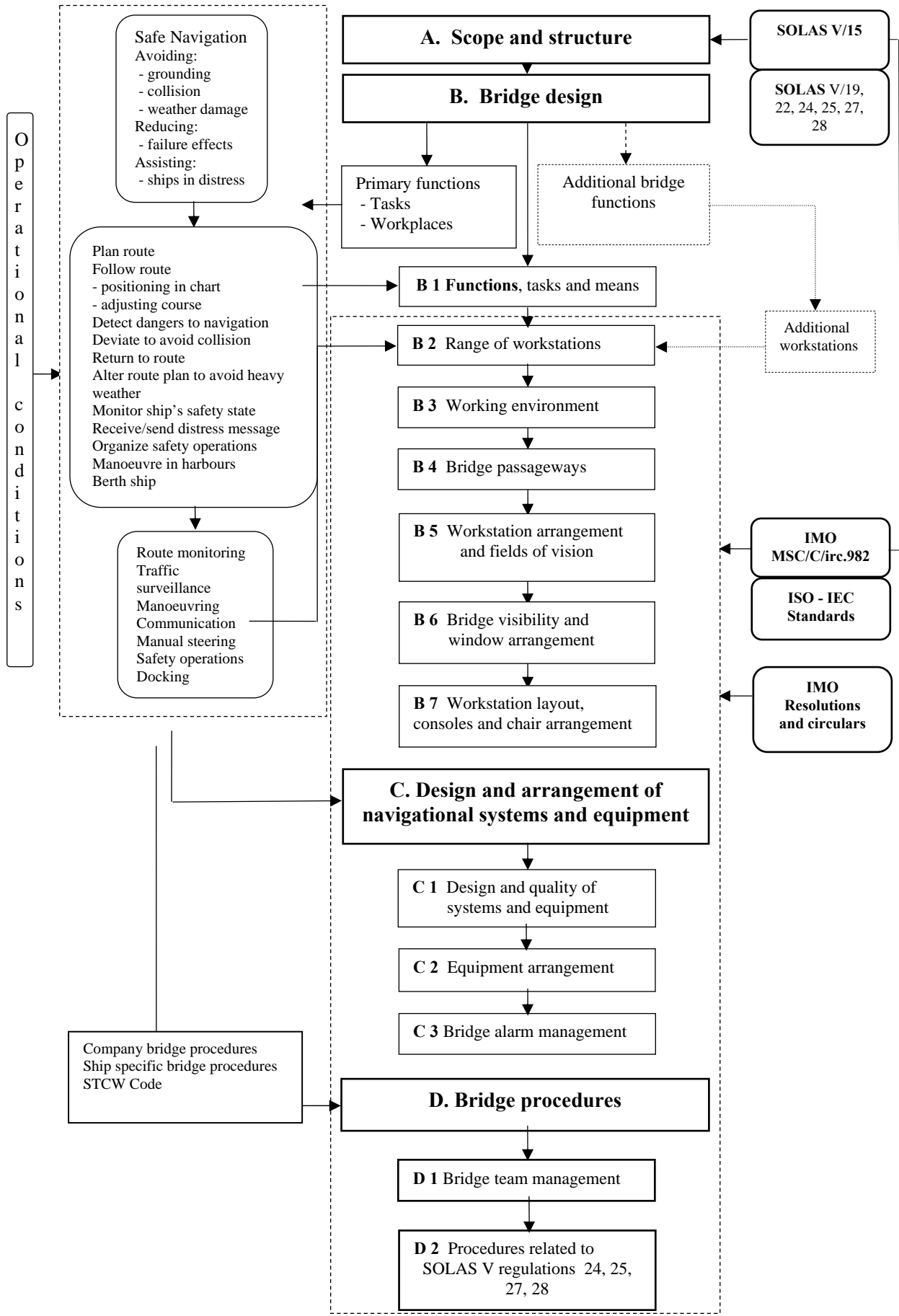

A. GENERAL	4
A 1 Scope and approach.....	4
A 2 Structure and application.....	5
A 3 Normative references.....	6
A 4 Informative references.....	6
A 5 Definitions.....	6
A 6 Documentation to be submitted by the ship builder for approval.....	10
A 7 Documentation to be submitted by the ship builder for information.....	12
A 8 Documentation to be submitted by the ship owners.....	12
B. BRIDGE DESIGN	14
B 1 Functions, tasks and means.....	14
B 2 Type and range of workstations.....	17
B 3 Working environment.....	18
B 4 Bridge passageways.....	20
B 5 Workstation arrangements and required fields of vision.....	21
B 6 Fields of vision and bridge window arrangement.....	27
B 7 Workstation layout, consoles and chair arrangement.....	28
C. DESIGN AND ARRANGEMENT OF NAVIGATIONAL SYSTEMS AND EQUIPMENT	31
C 1 Design and quality of navigational systems and equipment.....	31
C 2 Arrangement of navigational systems and equipment.....	32
C 3 Bridge alarm management.....	38
D. BRIDGE PROCEDURES AND OPERATING CONDITIONS	41
D 1 Bridge team management.....	41
D 2 Prevention of operational errors.....	42
D 3 Procedures related to SOLAS regulation 24, 25, 27 and 28.....	43
Annex A Guidance and examples relating to requirements of the Recommendation	43
Appendix 1 of Annex A Tasks and related means – Examples of location of main equipment.....	43
Annex B Facts and principles related to IACS Recommendation	43
Appendix 1 of Annex B Clarification of the content of each aim specified in SOLAS regulation V/15.....	43

A. GENERAL

A 1 Scope and approach

This Recommendation for bridge design, equipment arrangement and procedures (BDEAP) related to newbuildings is compiled and developed to cover the principles and aims of SOLAS V regulation 15, when applying the requirements of SOLAS regulations:

- V/19 “Carriage requirements for shipborne navigational systems and equipment”*
- V/22 “Navigation bridge visibility”*
- V/24 “Use of heading and/or track control systems”*
- V/25 “Operation of steering gear”*
- V/27 “Nautical charts and nautical publications”*
- V/28 “Records of navigational activities”*

taking SOLAS regulations V/18 and 20 into consideration.

The requirements of these SOLAS regulations affecting bridge design, design and arrangement of navigational systems and equipment on the bridge and bridge procedures, are harmonized with related guidelines of MSC/Circ.982 and relevant ISO and IEC standards for application of the SOLAS regulations in accordance with the aim of:

- .1 facilitating the tasks to be performed by the bridge team and the pilot in making full appraisal of the situation and in navigating the ship safely under all operational conditions;*
- .2 promoting effective and safe bridge resource management;*
- .3 enabling the bridge team and the pilot to have convenient and continuous access to essential information which is presented in a clear and unambiguous manner, using standardized symbols and coding systems for controls and displays;*
- .4 indicating the operational status of automated functions and integrated components, systems and/or sub-systems;*
- .5 allowing for expeditious, continuous and effective information processing and decision-making by the bridge team and the pilot;*
- .6 preventing or minimizing excessive or unnecessary work and any condition or distraction on the bridge which may cause fatigue or interfere with the vigilance of the bridge team and the pilot;*
- .7 minimizing the risk of human error and detecting such error if it occurs through monitoring and alarm systems, in time for the bridge team and the pilot to take appropriate action.*

Note:

See Appendix 1 of Annex B, “Facts and principles – Related to SOLAS V/15 and the IACS Recommendation”

A 2 Structure and application

A 2.1 IACS Recommendation BDEAP is structured to reflect the areas and aims addressed by SOLAS regulation V/15.

A 2.1.1 Requirements

The requirements set forth cover SOLAS regulations and applicable parts of MSC/Circ.982, enabling the standard to be used as a stand-alone document for the purpose of approval work during the building process, and are organized within the areas addressed by SOLAS regulation V/15:

- Bridge design
- Design and arrangement of navigational systems and equipment
- Bridge procedures

A 2.1.2 Guidance note

Guidance notes and examples as to how various requirements may be met by acceptable technical solutions or other remedies are given in the Annex A to the Recommendation. A guidance note given does not in any way exclude alternative solutions that may fulfil the purpose and intention of the requirement provided other requirements and the overall bridge functionality are not adversely affected.

A 2.1.3 Note

Notes are used to give useful information which does not necessarily affect the approval in relation to SOLAS regulation V/15, but may affect the choice of compliant solutions when relevant.

A 2.1.4 Annexes

Annex A of the Recommendation gives guidance and examples related to requirements, supported by Appendix 1

Annex B informs about facts and principles related to the understanding of SOLAS regulation V15 and the framework of the Recommendation, supported by Appendix 1

A 2.2 The content of the main document is through chapters B, C and D and is structured to reflect the main areas addressed by SOLAS regulation V/15 with the aim of enabling it to serve as a rational check list throughout an approval process for newbuildings.

A 2.3 Approval in accordance with the Recommendation gives evidence for compliance with SOLAS regulation V/15 when applying SOLAS regulations V/19, 22, 24, 25, 27 and 28 at the time of delivery of the newbuilding. See Annex B.

A 2.3.1 SOLAS regulation 19 and 22

Verification of compliance with SOLAS regulations V/19 and 22 includes verification of the ability of the bridge design, layout and equipment arrangement to promote effective and safe bridge resource management (see A 5.4) by ensuring that navigation bridge resources (see A 5.4.1), including information provided by visibility through bridge windows, are arranged to be made readily available for the bridge watch resources (see A 5.4.2), enabling safe performance of navigation functions and effective bridge team management (see A 5.5).

A 2.3.2 SOLAS regulation V/24, 25, 27 and 28

Procedures established for bridge resource management and for purposes specified in SOLAS regulations V/24, 25, 27 and 28 should become part of the ship's safety management system and included in the ISM certification.

A 3 Normative references

- Applicable parts of MSC/Circ.982 - Guidelines on ergonomic criteria for bridge equipment and layout
- MSC/Circ.603 - Guidelines on display sizes and techniques for navigational purposes
- IMO A.694(17) - General requirements for shipborne radio equipment forming part of the global maritime distress and safety system and for electronic navigational aids
- IMO A 830(19) - Code on alarms and indicators

A 4 Informative references

A. 4.1 IEC standards referred to in MSC/Circ.982 for relevant additional information:

- IEC 60945, Maritime navigation and radio communication equipment and systems - General requirements - Methods of testing and required test results
- IEC 61174, Electronic Chart Display and Information System (ECDIS) - Operational and performance requirements, methods of testing and required test results

A.4.2 ISM Code

A.4.3 Company and Ship Specific Bridge Procedures Manual

A 4.4 STCW 1978, as amended

A 4.5 Maritime Regulations for the Operation of the Panama Canal, NOTICE TO SHIPPING No.N-1, Navigation Bridge Features Required of Transiting Vessels

A 5 Definitions

For the purpose of this document:

A 5.1 Alarm: An alarm or alarm system which announces by audible and visual means a condition requiring attention.

A 5.1.1 *Accept*: Manual silencing of an audible alarm from remote position

A 5.1.2 *Acknowledge*: Manual silencing of audible alarm at the location of the equipment, bringing visual alarm to steady state

A 5.1.3 *Cancel*: Manual stopping of a visual alarm after the cause has been eliminated.

A 5.2 Bridge: The area from which the navigation and control of the ship is exercised, including the wheelhouse and bridge wings.

A 5.2.1 *Bridge wings*: Those parts of the bridge on both sides of the ship's wheelhouse which, in general, extend to the ship's side.

A 5.2.2 *Navigation bridge*: Area of a wheelhouse or enclosed bridge allocated navigating functions and control of the ship, and which includes any additional bridge workstation to be used by the officer of the watch.

A 5.2.3 *Totally enclosed bridge*: A bridge without open bridge wings, meaning that bridge wings form an integral part of an enclosed wheelhouse.

A 5.2.4 *Wheelhouse*: Enclosed area of the bridge.

A 5.3 Bridge function: A group of tasks, duties and responsibilities necessary for operation of the ship and carried out on the bridge.

A 5.3.1 *Primary bridge functions*: Functions related to determination, execution and maintenance of safe course, speed and position of the ship in relation to the waters, traffic and weather conditions.

Such functions are:

- route planning see A 5.16 and A 5.17.7
- navigating see A 5.13 and 5.17.2
 - route monitoringsee A 5.13.1
 - grounding avoidance see A 5.13.1.1
 - traffic surveillancesee A 5.13.2
 - collision avoidance see A 5.13.2.1
- monitoring safety see A 5.12.1
- manoeuvring see A 5.11 and A 5.17.2
 - alter course/headingsee A 5.13
 - change speedsee A 5.13
- monitoring see A 5.12 and A 5.17.1
- conning see A 5.9
- docking see A 5.10 and A 5.17.5
- external and internal communication see A 5.17.3
- manual steering see A 5.17.6

A 5.3.2 *Additional bridge functions*: Functions related to ship operations which should be carried out on the bridge in addition to primary functions, but not necessarily by the watch officer. Examples of such functions are:

- extended communication functions
- monitoring and control of ballasting and cargo operations
- monitoring and control of machinery
- monitoring and control of domestic systems

A 5.4 Bridge resource management: Safeguarding that the bridge team comprises a sufficient number of specific individuals, appropriately qualified and fit for the duties and responsibilities assigned, and that information, instruments and equipment are readily available for efficient and safe performance of the dedicated functions at allocated locations.

A 5.4.1 *Navigation bridge resources*: Information, instruments and equipment arranged to be made readily available for individual members of the bridge team at specific locations, enabling safe performance of duties and responsibilities, effective co-operation and easy communication between bridge team members.

A 5.4.2 *Bridge-watch resources*: Qualified and fit individuals that may be assigned duties and responsibilities relevant for performance of navigational functions and bridge team operations.

A 5.5 Bridge team management: Safeguarding that the composition of the bridge team is continuously appropriate in relation to operational conditions by manning dedicated workstations outfitted, arranged and located for performance of specific functions and effective and safe bridge team operations by properly trained and fit individuals; familiar with

instruments and equipment to be used and with their individual duties and responsibility as member of the current bridge team and with the function(s) to be performed at the individual workstations of the bridge team.

A 5.6 Close to: Within active reach (inside the wheelhouse).

A 5.7 Commanding view: View without obstructions which could interfere with the ability of the officer of the watch and the pilot to perform their main tasks, providing at least the field of vision required for safe performance of collision avoidance functions, requiring that the view of the sea surface forward of the bow to 10° on either side is not obscured by more than two ship lengths (2 x LOA), or 500m, whichever is less, and that a horizontal field of vision extends over an arc of not less than 225° - that is from right ahead to not less than 22.5° abaft the beam on either side of the ship.

Ref. SOLAS regulation V/22, 1.1, 1.2 and 1.3.

A 5.8 Close view of the sea surface: The view of the sea surface close to both sides of the ship's bow.

A 5.9 Conning station or position: Place in the wheelhouse arranged and located for monitoring and directing the ship's movements in narrow waters and buoy lanes by visual observations, providing a commanding view (A 5.7), close view of the sea surface (A 5.8) and the required information for conning (SOLAS regulation V/19).

A 5.9.1 *Additional conning station*: Workstation used for navigation, including conning, providing a commanding view with access to radar and navigational chart in addition to information required for conning by Reg.V/19, which may serve as alternative conning station for the pilot when required.

Note:

Both the conning station/position (A 5.9) and a workstation that may serve as additional conning station (A 5.9.1) need to provide a commanding view. The difference is that the commanding view in the first occurrence is provided at a position which also allows a close view of the sea surface, while the additional conning station provides additional information from instruments (radar/chart) and the commanding view from the working position at the radar, without necessarily providing a close view of the sea surface.

A 5.10 Docking: Manoeuvring the ship alongside a berth while controlling mooring operations.

A 5.11 Manoeuvring: Operation of steering systems and propulsion machinery as required to move the ship into predetermined directions, positions or tracks.

A 5.12 Monitoring: Observation of bridge operations and surrounding environment. See A 5.17.1.

A 5.12.1 *Monitoring safety state of the ship*: Act of constantly checking relevant information from instruments and monitoring systems related to the condition of the ship, its machinery and equipment in order to detect any irregularities. See A 5.17.4.

A 5.13 Navigating: Performance of route monitoring and traffic surveillance, execution of course alterations and speed changes as required to follow the pre-planned route and avoiding danger of grounding and collision.

A 5.13.1 *Route monitoring*: Monitoring the ship's position in relation to the planned route and the waters by deriving the ship's position from a continuous positioning system and a second

independent positioning method of a different type, determining course adjustments required to follow the route within acceptable track-errors and alteration of the course at severe off-track-errors as required to avoid the danger of grounding.

A 15.13.1.1 *Grounding avoidance*: Executing appropriate course adjustments for the ship to follow the route and alteration of the course to avoid the danger of grounding at excessive off-track-errors, taking into consideration the safe route, waters, traffic and dangers of collision.

A 5.13.2 *Traffic surveillance*: Observing the traffic visually and by means of instruments, revealing other ships' course and speed relative to own ship and determining dangers of collision.

A 5.13.2.1 *Collision avoidance*: Determining and executing adequate course and speed changes to avoid the danger of collision, taking into consideration the traffic pattern, the route back-to-track, dangers to navigation and the risk of grounding.

A 5.14 Operational conditions:

A 5.14.1 *Normal operational conditions*: When all shipboard systems and equipment related to primary bridge functions operate within design limits, and weather conditions or traffic do not cause excessive operator workloads.

A 5.14.2 *Irregular operational conditions*: When external conditions cause excessive operator workloads.

A 5.14.3 *Abnormal operational conditions*: When malfunction of technical system requires operation of backup systems on the bridge, or when it occurs during an irregular operating condition, or when the officer of the watch becomes unfit to perform his duties and has not yet been replaced by another qualified officer.

A 5.14.4 *Emergency situations*: When incidents seriously affect internal operating conditions of the ship and the ability to maintain safe course and speed (fire, ship system technical failure, structural damage).

A 5.14.5 *Distress situations*: Loss of propulsion and/or steering, or when the ship is not seaworthy due to other reasons (situation prior to abandon ship situation).

A 5.15 Waters:

A 5.15.1 *Ocean area*: Waters that encompass navigation beyond the outer limits of coastal waters. Ocean areas do not restrict the freedom of course setting in any direction for a distance equivalent to 30 minutes of sailing with the relevant ship speed.

A 5.15.2 *Coastal waters*: Waters that encompass navigation along a coast at a distance less than the equivalence of 30 minutes of sailing with the relevant ship speed. The other side of the course line allows freedom of course setting in any direction for a distance equivalent to at least 30 minutes of sailing with the relevant ship speed.

A 5.15.3 *Narrow waters*: Waters that do not allow the freedom of course setting to any side of the course line for a distance equivalent to 30 minutes of sailing with the relevant ship speed.

A 5.16 Route planning: Pre-determination of course lines, radius turns and ship speed in relation to the waters to be navigated.

A 5.17 Workstation: A workplace at which one or several tasks constituting a particular activity are carried out, designed, arranged and located as required to provide the information, systems and equipment required for safe and efficient performance of dedicated tasks and bridge team co-operations.

A 5.17.1 Workstation for monitoring: A workstation facilitating equipment and a commanding view for observation of the ship's heading and speed, the waters and traffic, incorporating means as required for route monitoring, used by the watch officer, assistant navigator or pilot as required for efficient bridge team operations.

Note:

The workstation is considered part of the workstation for navigating and manoeuvring (see A 5.17.2) for the purpose of route monitoring by the use of paper charts or ECDIS electronic back-up, and may serve as additional conning station (A 5.9.1 and B 5.6).

A 5.17.2 Workstation for navigating and manoeuvring: A workstation with commanding view used by navigators when carrying out route monitoring, traffic surveillance, course alterations and speed changes, and which enables monitoring of the safety state of the ship.

A 5.17.3 Workstation for communication: A workplace for operation and control of equipment for Global Maritime Distress and Safety System (GMDSS), and shipboard communication for ship operations under normal conditions and emergency situations.

A 5.17.4 Workstation for safety operations: A workplace dedicated for organisation and control of internal emergency and distress operations providing easy access to external and internal communication and information related to the safety state of the ship.

A 5.17.5 Workstation for docking: Workplace on bridge wings providing the field of vision and information required for controlling the manoeuvring of a ship alongside a berth, tug operations and mooring operations.

A 5.17.6 Workstation for manual steering: A workplace providing the field of vision, indicators and equipment required for steering the ship manually by a helmsman in accordance with orders received from the navigator responsible for bridge operations.

A 5.17.7 Workstation for planning and documentation: A workplace equipped for planning the route(s) of the complete voyage from departure to destination and documenting bridge operations during the voyage.

A 6 Documentation to be submitted by the ship builder for approval

A 6.1 Fields of vision drawings showing:

a) The overall horizontal field of vision from inside the wheelhouse (see B 5.4) and workstations for navigating and manoeuvring, monitoring, docking, manual steering and conning and any other workstation to be used by navigators. The drawings should include the arc of individual blind sectors and the sum of blind sectors forward of the beam and similar for the arc of 22.5° abaft the beam on either side of the ship.

b) The vertical field of vision over the bow under most unfavourable conditions of draught, trim and deck cargo seen from the conning station and workstations for monitoring and for navigating and manoeuvring. The drawing(s) should include the line of sight under the upper

edge of the window from standing working position at the workstation and over the lower edge of the front window from sitting position if applicable.

c) Window arrangement, including inclination, dimensions, framing and height of lower and upper edge above bridge deck surface and the height of the deckhead.

A 6.2 Bridge layout drawings showing:

a) The bridge layout, including the configuration and location of all bridge workstations, including workstations for additional bridge functions.

b) Configuration and dimensions of workstation consoles including console foundations.

A 6.2.1 Drawing of the chair with indication of min. and max. seat heights above the bridge deck surface should be submitted if chairs are to be installed for use at workstation consoles. See B 7.3.1.

A 6.3 Equipment location drawings showing:

a) Location of instruments and equipment in all workstation consoles.

b) Location of equipment located elsewhere on the bridge.

c) The distance between deckhead mounted equipment and bridge deck surface.

A 6.4 List of equipment showing:

All relevant bridge equipment with specification of type, model, manufacturer, supplier and type approval reference with extension date or copy of valid certificates, when applicable. See also the Note to C 1.1.

A 6.5 If an integrated navigation system, not type approved, is to be installed, the following documentation should be submitted:

a) the system configuration

b) functional description

c) factory acceptance test if applicable

d) failure mode and effect analysis (FMEA) for the system

A 6.6 If an integrated bridge system as defined in the IBS performance standard is installed, a failure mode and effect analysis (FMEA) for the system should be submitted.

A 6.7 Program for on board tests of equipment and systems

a) A program for the on board testing of the bridge equipment and systems required to be carried, as well as additional navigation equipment installed, should be submitted for approval at the earliest possible stage before sea trials.

b) The program to be submitted should include tests required to ascertain that all controls, indicators, displays and alarm functions operate in accordance with equipment and system specifications.

c) If an integrated navigation system is installed, a test program based on the failure mode and effect analysis (FMEA) for the system should be submitted. If the integrated system incorporates automatic route keeping, the test program should include tests of the track-keeping abilities.

d) If an integrated bridge system (IBS) is installed, a test program based on the failure mode and effect analysis (FMEA) for the system should be submitted.

A 6.8 *Ships of special construction or purpose*

Whenever the Society concerned determines that a ship of special construction or purpose cannot comply fully with these provisions without interfering with performance of special bridge functions, the bridge should comply with solutions determined by the Society to be the closest possible compliance with the relevant requirements in respect of that ship, based on a justification commonly agreed to by the shipbuilder and the owners and submitted by the shipbuilder.

A 6.9 If the bridge layout, provision of view, outfitting and location of workstations supporting safe and effective bridge team management do not conform to the principles and requirements set forth in this Recommendation, information describing the bridge functions and bridge team management during different operational conditions (see D 1.1), provided by the owner or operator, should be regarded an inclusive part of the documentation required in A 6.2 and A 6.3 to be submitted for approval by the shipbuilder. (See also A 8.2).

Note:

When deemed necessary for consideration of bridge arrangement or for submitting additional documentation to justify arrangement solutions, it is regarded the responsibility of the builder to ensure that the owner provides such information in the context of the building specification, disregarding the type of arrangement. Any such information should be submitted for information.

A 7 Documentation to be submitted by the ship builder for information

A 7.1 Manuals or instructions for equipment installed for the use of bridge personnel should be submitted for information upon request.

A 7.2 If a type approved integrated navigation system is to be installed, the following documentation should be submitted for information:

- a) the system configuration;
- b) functional description;
- c) type approval certificate;
- d) failure mode and effect analysis (FMEA) for the system, if applicable.

A 8 Documentation to be submitted by the ship owners

A 8.1 Ship specific bridge procedures should be included in the ship's management plan, available on the bridge for ISM certification, covering:

- distribution of bridge functions and tasks (see B 1);
- manning and training requirements on the bridge at identified operating conditions, taking into account the requirements in B 1 and D 1;
- familiarization schemes applicable for bridge personnel as required by STCW, SOLAS regulation I/14, para 1.4;
- the use of the heading and/or track control system, operation of steering gear, updating of nautical charts and recording of navigational activities proving compliance with SOLAS regulations V/24, 25, 27 and 28.

A 8.2 If outfitting and location of workstations and bridge team management do not conform to the principles and requirements set forth in this Recommendation, the ship owner or operator should provide the builder with information describing bridge functions and operational procedures, including bridge team management during different operational conditions (see D 1.1), which is to be included in the documentation required in A 6.2 and A 6.3 (See also A 6.9).

Note:

When required, the owner or operator should ensure that this information is provided in the context of the building specification. See Note to A 6.9.

A 8.3 Description of functions to be performed at workstations which are additional to workstations for primary bridge functions should be submitted.

A 8.4 If operational procedures are required to compensate for accepted technical solutions interfering with the functionality of the bridge, such procedures should be included in the ship's specific procedures for bridge operations.
(See A 6.6).

B. BRIDGE DESIGN

The bridge shall be designed and arranged with the aim of:

- *facilitating the tasks to be performed by the bridge team and the pilot in making full appraisal of the situation and in navigating the ship safely under all operational conditions*
- *promoting effective and safe bridge resource management*
- *allowing for expeditious, continuous and effective information processing and decision-making by the bridge team and the pilot*
- *preventing or minimizing excessive or unnecessary work and any condition or distraction on the bridge which may cause fatigue or interfere with the vigilance of the bridge team and the pilot*

Ref. SOLAS V/15.1, 15.2, 15.5, 15.6

The design of bridges is governed by:

- the functions and related tasks to be carried out on the bridge, systems used and methods of task performance
- the range, layout and location of workstations required for performance of bridge functions
- the fields of vision required for visual observations from each of the workstations
- composition of the bridge team and the procedures required for safe operations under all identified conditions
- the type and range of equipment to be provided for performance of the tasks at the individual workstations and elsewhere on the bridge

Design requirements are related to application of SOLAS regulations V/19 and 22.

B 1 Functions, tasks and means

The bridge shall be designed with the aim of:

- *facilitating the tasks to be performed by the bridge team and the pilot in making full appraisal of the situation and navigating the ship safely under all operational conditions*

Ref. SOLAS regulation V/15.1

The table below shows the main bridge functions and tasks to be carried out on the bridge and relevant location of equipment, if installed. The table may serve as a general reference for outfitting of workstations. Mandatory equipment to be installed for different ship sizes (SOLAS regulation V/19) is indicated in Table C 3.1.

The type of equipment installed on the individual bridge, the system configurations and automation level may affect the method of navigation, operational procedures and qualification levels. It is regarded to be the responsibility of the owners and users that procedures, knowledge and training of the bridge personnel are related to the individual ship's bridge system. Such issues should be documented in the Company and Ship specific bridge procedures manual and documented in the ISM Code procedures manual for the vessel.

(See A 8.1, A 8.2)

Tasks and means			
Tasks to be performed	Equipment to be operated	Information to be viewed	Remarks
Navigation			
– Grounding avoidance			
Planning			
Plan route prior to departure	Paper chart/table Nautical publications		
Alter route while under way	GNSS (GPS) ECDIS* ECDIS backup**		* Optional installation ** If replacing paper
In Transit			
Monitor route-keeping: - Determine position by bearings - Read position on display - Plot position	Pelorus/gyro repeater* Radar GNSS (GPS) Paper chart/table		* Analogue Bearings 360° around the horizon, (one on each bridge wing) Additional pelorus at nav. workstation is recommended if feasible.
- Determine and plot position automatic	ECDIS		Optional installation
Maintain route/alter course by - manual steering - using autopilot - automatic route-keeping	Manual steering control Heading control system Track control system* (ECDIS)		* Alternative to heading control Interfaced to ECDIS, gyro, speed, radar when part of INS
Give sound signals	Whistle control		Fog – traffic
Receive sound signals	Sound reception system	Loudspeakers	Totally enclosed bridge
Monitor/Take action: - operational warnings - system failure alarms	Alarm panel		If installed
- ship's safety state	Alarm systems		
Monitor heading, turn, rudder angle, speed, propulsion		Gyro repeater Indicators: - rudder angle - rate-of-turn* - RPM, Pitch - speed log	* > 50 000 grt
Adjust lighting	Dimmer buttons		
Monitor shallow water areas	Echo Sounder system	Water depth	(Anchoring)
Monitor performance automatic route-keeping system		Conning info display	Optional Organizing indicator info providing situation awareness when in automatic route-keeping mode
Effect internal communication	Intercom (auto telephone)		
Effect external communication	VHF		Related to navigation
Receive/send distress message	GMDSS equipment or remote control		If applicable
Traffic surveillance – Collision avoidance			
Detect floating targets Analyse traffic situations Observe visually	Radar with ETP* (may incl. AIS) Binoculars Window wiper -cleaning - heating control Clear-view screen* AIS (automatic ident. system)	Targets' relative position, course, speed. Expected passing distance Time Target true pos., course, speed	* Electronic target plotting (“historical” data) * If installed
Decide on collision avoidance measures			(For route-keeping)
Manoeuvring			
Change steering mode	Steering mode switch		
Alter heading	Heading control	Heading (Gyro)	
Observe rudder angle		Rudder angle	
Override steering	Override control		If applicable
Manual steering control			
Change speed	Propulsion control	RPM/Pitch	
Give sound signals	Whistle control		
Receive sound signals	Sound reception system	Loudspeaker	Totally enclosed bridges

Tasks and means			
Tasks to be performed	Equipment to be operated	Information to be viewed	Remarks
Navigate back to route	Paper chart/table GNSS (GPS)		
Maintain track of traffic	Radar with route and navigable waters		
	ECDIS*		* May replace paper if w/backup
Harbour manoeuvring	Thruster		Optional
Anchoring			
Manoeuvre	Manual steering control Propulsion control (Thruster control.)*	Heading Rudder angle RPM/Pitch Water depth Targets Ship's position	Performed at front workstations or in combination with docking station Information to be provided for pilots * Optional
Monitor the depth Positioning (Identify anchor position)	Echo sounder Radar Chart GNSS (GPS)		
Observe ship's safety state			
Monitor alarm conditions: - Navigation Equip. & system failures Operational warnings	Main alarm panel w/indicators and acceptance button*	Alarm list	* If applicable See chapter C 2
- Machinery condition		Machinery alarms	Installations related to the ship's specification
- Cargo condition		Cargo alarms	
- Fire interior machinery cargo		Fire alarms	
Manual steering			<i>(Rating)</i>
Maintain, adjust, alter heading according to order	Steering control Intercom (Command)	Gyro repeater Magnetic comp. Rudder angle Rate-of-turn*	* > 50 000 grt
Conning functions			
Determine & direct course and speed in relation to waters and traffic			
Monitor:			
- heading		Gyro repeater	May be digital
- rudder angle		Rudder angle	
- rate-of-turn		RoT indicator	> 50 000 grt
- propulsion		RPM/Pitch	
- speed		Speed log	
- water depth		Echo sounder display	Anchoring
Give sound signals	Whistle control button		
Effect communication	VHF		Available
Documentation	Log-book or equivalent		Manual or Electronic – Legal !
Safety operations			
Take action on alarm condition: - analyse situation - consult plans and drawings	Manuals – Drawings – (PC)		May be computer based info
- observe ship's external operational situation			Cooperation with navigating officer
- organize and execute measures by communication - check status of ventilation system	Intercom (UHF) Emergency stop		
Monitor development of alarm conditions	Alarm panel/screen		If applicable
- Cargo alarms	Alarm panel		If installed
- Fire detection & alarms	Fire detection + alarm panel		
- Gas & smoke detection			
External communication			

Tasks and means			
Tasks to be performed	Equipment to be operated	Information to be viewed	Remarks
Distress - weather - safety	GMDSS equipment		As required (Area)
Determine weather conditions Consider navigation warnings	Navtex receiver		
Public correspondence	Additional equipment		Specified by owners
<i>Docking operations (bridge wings)</i>			
Directing steering	Intercom (command)	Heading Rudder angle	
Directing speed	Intercom (command)	RPM/Pitch	
Giving sound signals	Whistle control button		
Receiving sound signals	Sound reception system	Loudspeaker	Totally enclosed bridge
Perform manoeuvring	Steering Propulsion control Thruster control*		* Optional
<i>Additional functions</i>			
			See Chapter B 2

B 2 Type and range of workstations

The ship's navigation bridge should not be used for purposes other than navigation, communications and other functions essential to the safe operation of the ship, its engines and cargo, and workplaces should be arranged with the aim of:

- *facilitating the tasks to be performed by the bridge team and the pilot in making full appraisal of the situation and in navigating the ship safely under all operational conditions*
- *promoting effective and safe bridge resource management*

Ref. SOLAS V/15.1, 15.2

B 2.1 Individual workstations for performance of primary bridge functions including pilotage should be provided for:

- navigating and manoeuvring.... see A 5.17.2
- monitoring see A 5.17.1
- manual steering see A 5.17.6
- docking on bridge wings see A 5.17.5
- planning see A 5.17.7
- safety operations see A 5.17.4
- communication see A 5.17.3
- conning see A 5.9

(See A 6.2 and A 6.3)

B 2.2 Additional workstations may be arranged for performance of other functions than those related to primary bridge functions when relevant.

(See A 5.3.2)

B 2.3 Functions to be performed at any workstation for additional functions should be identified at the planning stage of the newbuilding. The category of functions (workstations) needs to be known to enable consideration and approval of the location of such workstations on the bridge in relation to the use of the regular workstations and bridge team management. See A 8.3 and D 1.1.

Note:

The main types of additional bridge workstations may be divided into three distinct categories based on purpose and functions and whether they are to be operated by the watch officer or not:

- A. Workstations for functions regarded related to operation of the ship, its engines and cargo:
 - a) to be monitored and controlled by the officer of the watch
 - b) to be used by other personnel than the officer of the watch
- B. Workstations for functions not regarded essential to safe operation of the ship and to be used by other personnel than the watch officer, but located on the bridge for practical reasons.

Disregarding the type of additional functions to be carried out, when such functions are included as part of the responsibility of the officer of the watch, it must be taken into consideration that additional functions will always have a lower priority than performance of primary functions.

See B 5.14 – B 5.16.

See Guidance note, Annex A.

B 3 Working environment

The bridge shall be designed and arranged with the aim of:

- *preventing or minimizing excessive or unnecessary work and any condition or distraction on the bridge which may cause fatigue or interfere with the vigilance of the bridge team and the pilot*

Ref. SOLAS V/15.6

Internal environmental conditions on the bridge that may affect human performance are:

- temperature
- humidity
- ventilation
- noise
- vibration
- illumination and type of lighting
- glare and reflection
- interior colours
- occupational safety

B 3.1 The enclosed bridge or wheelhouse should be provided with air conditioning or a ventilation system for regulation of temperature and humidity helping to avoid that the thermal response of the body affects efficient task performance under various operating conditions.

Note:

Temperatures which are not less than 18°C in cold climates and do not exceed 27°C in tropical climates are regarded feasible for normal bridge watch conditions. These temperatures are based on relatively still air and normal air humidity (40% – 60%). Higher temperatures are acceptable if airflow is increased and humidity is lowered.

B 3.2 Ventilation system with suitable air flow velocity and rate of air circulation should be provided. Direction of air flow from air conditioning and heating systems towards workplaces should be avoided.

B 3.3 Excessive levels of noise interfering with voice communication, causing fatigue and degrading overall system reliability, should be avoided.

See Guidance note, Annex A.

B 3.4 Vibrations when the ship is at normal transit speeds should not affect the reading of indicators or the performance of bridge equipment.

B 3.5 Lighting arranged for adjustment of illumination and direction of light should be provided at all workplaces and lighting should always be arranged at entrances and exits of enclosed workplace areas. Light controls should be visible in darkness. The illumination brightness should be sufficient for safe performance of the tasks and possible to dim down to zero. White ceiling lights do not require dimming facilities.

B 3.6 Lighting that may be required for continuous operations during darkness and in entrances to the bridge should be of a type that provides the least impact on night vision, with adjustable brightness to suit the operations and ease visual adaptation to darkness.

See Guidance note, Annex A.

B 3.7 It should be possible to dim equipment displays and indicators providing information to individual workstations and the lighting covering the workstation area, at the workstation in use.

B 3.8 Light sources should be arranged and located in a way that prevents glare, stray image and mirror effects in bridge windows and deckhead areas above workstations.

See Guidance note, Annex A.

B 3.9 To reduce the risk of personnel injury during bridge operations,

- the wheelhouse floor, bridge wings and upper bridge decks should have non-slip surfaces;
- hand- or grab-rails should be installed as required at workstations, passageways and entrances, enabling personnel to move and stand safely when the ship is rolling and pitching in heavy weather;
- chair deck rails installed at workstations should be provided with anti-trip skirting board or be flush mounted;
- stairway openings should be protected if not sufficiently lit or otherwise indicated during darkness;
- sharp edges or protuberances which could cause injury to personnel should be avoided;
- deck mounted hatches and manhole covers set into the wheelhouse, bridge wings and upper bridge decks should be flush fitting to remove trip hazards.

B 3.10 Personnel safety equipment to be stored on the bridge should be clearly marked and easily accessible.

B 3.11 All portable items, including safety equipment, tools, lights and pencils should be stored at dedicated places.

B 4 Bridge passageways

The bridge should be designed and arranged with the aim of:

- *promoting effective and safe bridge resource management*

Ref. SOLAS V/15.2

Bridge passageways should facilitate the expected movement of the bridge team between individual workstations, bridge entrances, exits and windows in carrying out the bridge tasks safely and effectively including the maintenance of equipment.

B 4.1 A clear route across the wheelhouse, from bridge wing to bridge wing for two persons to pass each other, should be provided. The width of the passageway should preferably be 1200 mm and not less than 700 mm at any single point of obstruction and allow easy access to side doors.

B 4.2 The distance between separate workstation areas should be sufficient to allow unobstructed passage for persons not working at the stations. The width of such passageways should not be less than 700 mm, allowing for a persons sitting or standing at their workstations.

B 4.3 The distance from the bridge front bulkhead, or from any console and installation placed against the front bulkhead to any console or installation placed away from the bridge front, should be sufficient for one person to pass a stationary person. The width should preferably be 1000 mm and not less than 800 mm.

B 4.4 The distance between bridge wing consoles, if installed and bulkheads should be as little as possible for easy operation of controls from both a position behind and beside the console giving optimum view of the ship's side and the mooring operations, but wide enough for one person to pass the console. The width of the passageway should preferably be 600 mm.

Note:

The Panama Canal Commission (PCC) requires that a minimum of 1 metre clearance from consoles or obstructions shall be provided from the forward to aft portions of the bridge wing ends. Special requests for relaxation of this requirement may be considered on a case-by-case basis.

B 4.5 The clear deckhead height in the wheelhouse should take into account the installation of deckhead panels and instruments as well as the height of door openings required for easy entrance to the wheelhouse. The following clear heights for unobstructed passage should be provided:

- a) The clear height between the bridge deck surface covering and the underside of the deck head covering should be at least 2250 mm.
- b) The lower edge of deck head-mounted equipment in open areas and passageways, as well as the upper edge of door openings to bridge wings and other open deck areas should be at least 2100 mm above the deck.
- c) The height of entrances and doors to the wheelhouse from adjacent passageways should not be less than 2000 mm.

B 4.6 All wheelhouse doors should be operable with one hand. Bridge wing doors should not be self closing and means should be provided to hold the doors open.

B 5 Workstation arrangements and required fields of vision

The bridge should be designed and arranged with the aim of:

- *facilitating the tasks to be performed by the bridge team and the pilot in making full appraisal of the situation and in navigating the ship safely under all operational conditions*
- *promoting effective and safe bridge resource management*
- *allowing for expeditious, continuous and effective information processing and decision-making by the bridge team and the pilot*
- *preventing or minimizing excessive or unnecessary work and any condition or distraction on the bridge which may cause fatigue or interfere with the vigilance of the bridge team and the pilot*

Ref. SOLAS regulations V/15.1, 15.2, 15.3, 15.5, 15.6

The workstations for primary bridge functions should be arranged to serve their functions under all operating conditions and different manning of the bridge and provide the fields of vision required for visual observations and easy cooperation between bridge personnel, promoting effective and safe bridge resource management.

B 5.1 Workstations for navigating and manoeuvring and for monitoring should be arranged within an area spacious enough for two persons to carry out the tasks in close cooperation, but sufficiently close together to enable the watch officer to control and safely carry out all the tasks from one working area under normal operating conditions.

See Guidance note, Annex A.

Note:

The sketch below shows the relative location of working positions for route monitoring and traffic surveillance with easy access to equipment serving both functions, allowing efficient performance by a single watch officer or two persons in close cooperation as required by operating conditions. This arrangement is based on manual position-fixing in paper charts for route monitoring:

Route monitoring Monitoring	Alarms Commun. Manoeuvr.	Traffic surveillance
--------------------------------	--------------------------------	-------------------------

Figure B5.1 A: *Basic workstation arrangement for Navigating and manoeuvring – Monitoring*

The sketch below shows workstations arranged for the use of electronic chart system incorporating automatic position-fixing (ECDIS with back-up arrangement). When an electronic chart system is installed, enabling route monitoring, traffic surveillance and manoeuvring from one working position, the workstation for monitoring, may also serve as the conning position to be used by pilots if located close to centre windows.

Back-up nav. system Monitoring Conning	Alarms Comm. Manoeuvr.	Traffic surveillance Route monitoring ECDIS
--	------------------------------	---

Figure B 5.1 B: *Workstation arrangement for Navigating and manoeuvring – Monitoring – Conning, based on the use of ECDIS w/backup arrangement*

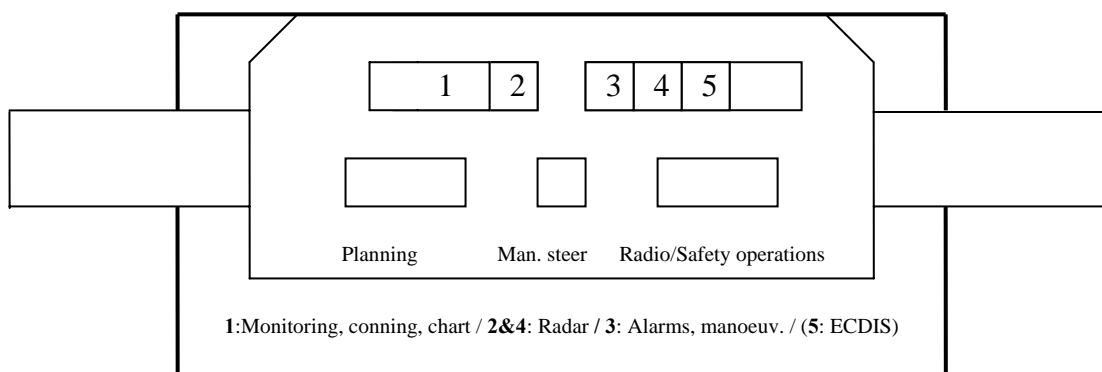

Figure B 5.1 C: Example of basic bridge layout and location of main equipment for ships < 3000 grt

Front chart table for paper charts (1) may serve as workstation for planning provided the ship is trading waters not requiring re-planning of route during route monitoring and that the chart table is sufficiently dimensioned. ECDIS of flat panel type may preferably be included in the centre console (3), when installed on a narrow bridge.

B 5.2 The working positions at workstations for performance of route monitoring and traffic surveillance should be arranged for working in standing as well as seated position with optimum field of vision.

B 5.3 The view of the sea surface, blind sector limitations and the field of vision, specified in SOLAS regulation V/22 “Navigation bridge visibility” to facilitate the tasks to be performed by the bridge team and the pilot in making full appraisal of the situation and in navigating the ship safely under all operational conditions as specified in SOLAS regulation V/15.1 should be provided at bridge workplaces which include the task of conning,

- enabling the bridge team and the pilot to have convenient and continuous access to essential information (Reg.V/15.3) by visual observations;
- promoting effective and safe resource management (Reg.V/15.2);
- allowing for expeditious, continuous and effective information processing (Reg.V/15.5).

B 5.3.1 It should be possible to observe all objects of interest for the navigation such as ships and lighthouses, in any direction from inside the wheelhouse by providing a horizontal field of vision to the horizon of 360°.

See Guidance note, Annex A.

B 5.3.2 For safe performance of bridge functions, including conning, it should be possible for the bridge team and the pilot to eliminate the effect of blind sectors outside the wheelhouse by moving within the area of each their dedicated workplace and to eliminate blind sectors caused by divisions between windows without leaving the working position at the chair.

B 5.4 A conning position, the workstation for monitoring and the workstation for navigating and manoeuvring should provide a commanding view enabling maintenance of visual traffic surveillance for safe conning of the ship by the officer of the watch and the pilot, requiring that:

- the view of the sea surface is not obscured by more than two ship lengths (2 x LOA), or 500m, whichever is less, forward of the bow to 10° on either side under all conditions of draught, trim and deck cargo.
- the horizontal field of vision extends over an arc of not less than 225° - that is from right ahead to not less than 22.5° abaft the beam on either side of the ship.

See Guidance note, Annex A.

Note:

For ships to be navigating narrow waters and harbour entrances requiring exact course-keeping, the owners should consider the need for the bridge to provide the field of vision as required for using lights in line astern of the ship as a visual reference from the navigating and manoeuvring workstation, and include this requirement in the building specification.

B 5.5 The commanding view required for safe conning shall be complied with at a position equipped as required by Reg.V/19.2.5.4, providing a close view of the sea surface for safe directing of the steering and speed in narrow canals and buoy lanes.

B 5.5.1 A workstation for monitoring located close to the forward centre window, not required by the ship's personnel during pilotage may serve as the conning position specified in B 5.5.

Note:

- a) The Panama Canal Commission (PCC) requires that the conning position be located "directly behind and next to" the centre front window and the nearest window thereto on each side that provides a clear and unobstructed view ahead for conning during canal transit. A minimum of 1 metre clearance from consoles or obstructions should be provided. Special requests for relaxation of this requirement may be considered on a case-by-case basis.
- b) PCC requires that the conning position shall provide a view of the sea surface forward of the bow from 1.5 ship's length when at ballast load line and 1 ship's length at full load line.

B 5.6 Workstations for the functions of monitoring and navigation equipped with radar and navigational chart should provide a commanding view in accordance with the requirements for safe conning, to be used by the ship's officers and for serving as additional conning stations for alternative use by the pilot when equipment installed at the workstations is required for additional information and the view of the sea surface close to both sides of the ship's bow is not required.

Note:

The viewing point to be used for calculation of the required view and fields of vision from a conning position at the front bridge window should be the working position 75 cm aft of the window and the working position 35 cm aft of the radar consoles, whether the workstations are equipped with a chair or not. This also applies when a workstation with radar is located at a front window also serving as the position for conning.

B 5.7 Workstations for monitoring, navigating and manoeuvring should provide the required horizontal fields of vision from a seated working position and should not be located directly behind large masts, cranes, etc. which obstruct the view right ahead from the workstation. See Guidance note, Annex A.

B 5.8 No blind sector caused by obstructions outside of the wheelhouse forward of the beam which hampers the view of the sea surface as seen from a conning position and the workstation for navigating and manoeuvring, shall exceed 10°. The clear sectors between blind sectors shall be at least 5°. Within a sector from right ahead to at least 10° on either side, each individual blind sector shall not exceed 5°. The total arc of blind sectors forward of the beam shall not exceed 20°.

B 5.8.1 The total arc of additional blind sectors between the beam and 22.5° abaft the beam on either side should not exceed 10°, allowing a total of 30° within the required total field of vision of 225°. To ensure a total field of vision of 225° for proper look-out and safe conning, a clear sector of at least 5° shall extend from 22.5° abaft the beam and forward on either side of the ship. See also B 5.5. See Guidance note, Annex A.

Note:

See Figure and Table B 5.8 below for overview of maximum allowed blind sectors and minimum clear sectors. See also Guidance note of B 5.16.

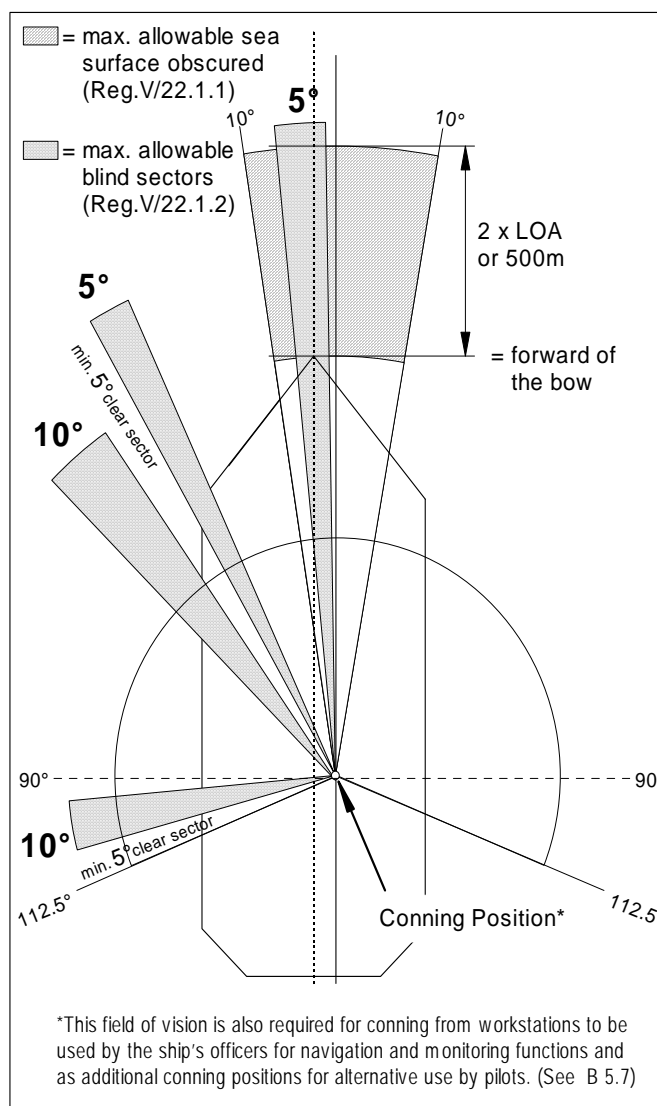

Figure B 5.8 (See B 5.4) Example illustrating the required horizontal field of vision of 225° with a maximum total arc of blind sectors of 20° forward of the beam and 10° abaft the beam, and indication of the vertical field of vision required within the sector of 20° right ahead.

Arc (size)	Max. individual blind sector	Max. allowed blind sector	Min. clear sector
Fwd. of the bow to 10° on each side (20°)	5°	10°	
Fwd. of the beam (180°)	10°	20°	
Abaft the beam (2 x 22.5°)	10°	10°	
Within total horizontal field of vision (225°)	10°	30°	
Clear sectors between blind sectors			5°
Min. clear sector from 112.5° and forward each side			5°

Table B 5.8

B 5.9 Blind sectors as specified in Reg.V/22.1.2, caused by cargo, cargo gear and other obstructions forward of the beam should be as few and small as possible and not in any way influence safe look-out from positions arranged, located and equipped to be used for conning by the bridge team and the pilot.

See A 5.7 and A 5.7.1.

B 5.9.1 Only blind sectors that cannot be avoided due to unusual structure and size of the cargo units to be stowed on deck and fixed structures regarded a prerequisite for the performance of specific ship functions and required for the purpose of safe operations of cargo and the ship may be included in the blind sector limits allowed by SOLAS regulation V/22, taking into account B 5.3.2 of this Recommendation.

Note:

Composition of the bridge team as required to ensure continuous look-out and safe conning by eliminating the effect of additional blind sectors caused by carriage of uncommon cargo on deck not enabling conformance with B 5.3.2 is considered the responsibility of the captain and the officer in charge of the navigational watch. Relevant considerations may need acceptance by the flag state Administration.

B 5.9.2 Regular cargo (such as cargo container units) stacked on deck in the field of vision forward of the beam should not obstruct the view of the sea surface at the horizon as seen from positions arranged, located and equipped to be used for conning by the bridge team and the pilot. See A 5.7 and A 5.7.1.

B 5.9.3 The height of stacked cargo should not exceed the line of sight of the sea surface forward of the bow specified in Reg.V/22.1.1.

B 5.10 The workstation for manual steering should preferably be located on the ship's centre line and should not interfere with the functions to be performed by the officer of the watch. The steering position should provide a forward field of vision not less than 60° to each side. If large masts, cranes, etc., obstruct the view in front of the workstation, it should be located some distance to starboard of the centre line, sufficiently to obtain a clear view ahead. It is not required to arrange the manual steering stand to be used in seated position.

B 5.11 When the workstation for manual steering is located off centre, or the bow of the ship cannot be seen from the steering position, special steering references (sighting marks) should be installed forward of the steering position. The steering references should be installed in line parallel to the ship's centre line for use by day and by night.

B 5.12 The ship's side should be visible from the bridge wing. Equipment for docking operations from the bridge wings, or a workstation console if installed, should be located to enable visual observations required for safe manoeuvring of the ship, monitoring of tug and mooring operations and should provide a field of vision from not less than 45° on opposite bow to right astern from the working position as shown in Figure A.

B 5.13 There should be a close approach access to at least one front window providing the view of the area in front of the accommodation superstructure. The access should not interfere with the use of a conning position arranged for pilots at the front window.

B 5.14 Workstations for additional functions which are of the category to be monitored and controlled by the watch officer as specified in B 2.3-A(a) should provide the field of vision required to maintain efficient look-out and enable monitoring of the ship's heading and rudder angle. (See also last part of the guidance note to B 5.5).

B 5.15 The location of a workstation for additional functions regarded essential for safe operation of the ship and to be used by other personnel than the watch officer should not in any way influence the performance of primary bridge functions.

B 5.16 Workstations for additional functions not essential to the safe operation of the ship, its engines and cargo, or furniture arranged for meetings or relaxation inside the wheelhouse

should not be installed within the area of the navigating bridge or within fields of vision, which are required for traffic surveillance from workstations. If such workstation or furniture arrangement is installed close to these areas, the use of it should in no way influence the performance of primary bridge functions, neither by use of light, noise disturbance or visual distraction. Ref. IMO Res. A.708 (17).

Note:

The figure below shows the principles for bridge layout with front workstations arranged for operations in seated and standing position and with bridge wing bulkheads/window frames) in line of sight from the working positions in seated position.

Main positions for performance of the tasks for route monitoring and traffic surveillance, and the location of chairs if fitted, are at radar consoles with easy access to nautical charts.

Appropriate field of vision is required from the workstations for radio operations if it is to be used by the officer of the watch (see Figure B).

A bridge area which may be regarded outside the navigating bridge and the sectors of required *field of vision from workstations* is indicated.

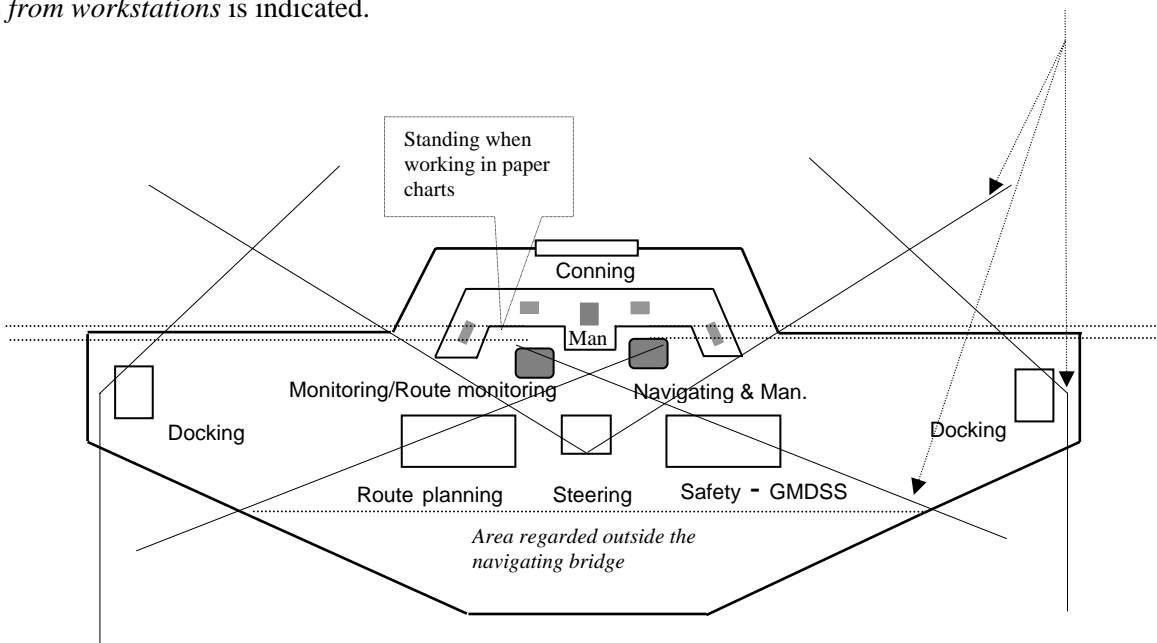

Figure A Required field of vision from workstations and example of bridge layout promoting BRM.
(Position-fixing in paper charts - Passageway and conning position in front.)

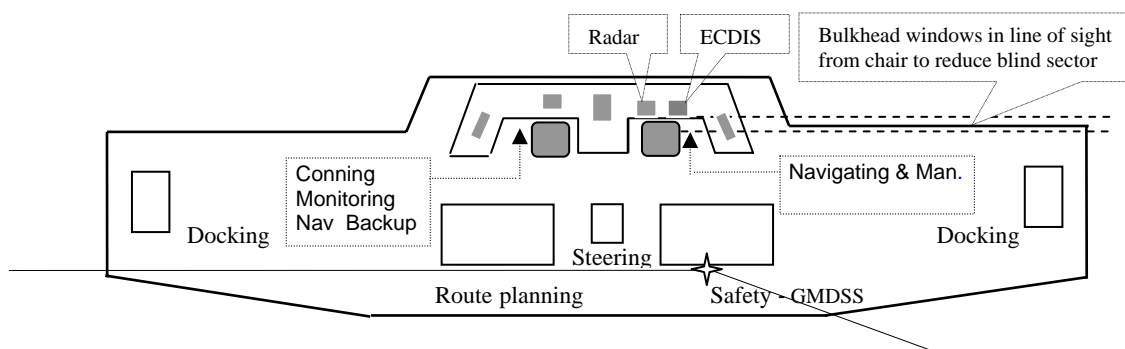

Figure B Required field of vision from the radio station when to be controlled and infrequently used for short periods of time by the watch officer.

(Navigation based on electronic chart system (ECDIS) – Conning position at console.)

Note to Figure B:

Location of ECDIS at the workstation for navigating and manoeuvring (incl. traffic surveillance) enables position-fixing at this position and makes the area a complete workstation (WS) for the navigation function and manoeuvring. This leaves the workstation for navigation backup/monitoring available to the pilot for conning when installed at the front bulkhead. Access to front windows is maintained.

B 6 Fields of vision and bridge window arrangement

The bridge should be designed with the aim of:

- *facilitating the tasks to be performed by the bridge team and the pilot in making full appraisal of the situation and in navigating the ship safely under all operational conditions*
- *allowing for expeditious, continuous and effective information processing and decision-making by the bridge team and the pilot*

Ref. SOLAS V/15.5

B 6.1 The bridge front windows should be inclined from the vertical plane, top out, at an angle not less than 10° and not more than 25° to help avoid reflections. Polarized and tinted windows should not be fitted.

B 6.1.1 Side and rear windows should be inclined from the vertical plane top out at an angle not less than 4°~5° when required to avoid glare, stray image and mirror effects from light sources not arranged and located to prevent reflection.

Note:

Due to danger of damage during transit, the Panama Canal Authorities may not accept that side windows extend outside the maximum breadth of the ship for certain sizes of ships.

B 6.2 The lower edge of windows should not present an obstruction to the view forward of the bow seen from a seated position at the workstations for monitoring, navigating and manoeuvring

See Guidance note, Annex A.

B 6.3 The upper edge of the front windows should allow a forward view of the horizon for a person with a height of eye of 1800 mm at the navigating and manoeuvring workstation when the ship is pitching in heavy seas. If 1800 mm height of eye is considered unreasonable and impractical, a reduction of the eye height may be accepted, but not to less than 1600 mm. See Guidance note, Annex A.

Note:

The minimum height of the upper edge of front windows of 2000 mm may be accepted even if the vertical field of vision is less than 5° above the horizontal line from a standing height of 1800 mm, provided adequate chairs are installed for easy viewing from sitting position at the workstations when the ship is pitching in heavy seas and there is a passageway in front of the workstations enabling appropriate view from standing position.

B 6.4 Framing between windows should be kept to a minimum and not be installed immediately forward of any workstation or in the centreline. If stiffeners between windows should be covered, this should not cause further obstruction of the view.

See Guidance note, Annex A.

B 6.5 A clear view through at least two of the navigation bridge front windows and, depending on the bridge configuration an additional number of clear-view windows should be provided at all times, regardless of weather conditions, in accordance with Reg.V/22.1.9.4. The windows providing a clear view should include windows within the field of vision required for conning, seen from the viewing point at workplaces arranged to be used by the bridge team and the pilot for conning.

B 6.5.1 Sunscreens of roller blind type with minimum colour distortion, heavy duty blade type wipers,* fresh water window washing and efficient de-icing and de-misting system or other means should be installed as required to help maintaining a clear view through windows. A catwalk or other means should be provided if required to help maintenance of window wipers and manual cleaning of bridge front windows. ~~See: 2.6.1, UI V/22.~~

Technical systems installed should comply with appropriate ISO standards*

* ISO 17899 Marine electric window wipers.

B 6.5.2 Clear view screens, if provided, should not be installed in windows in front of the manual steering position and radars, and not more than one to each side of the centre line, available for conning.

B 7 Workstation layout, consoles and chair arrangement

The configuration of workstations and consoles should provide a workplace for rational and user-friendly placing of equipment, with the aim of:

- *facilitating the tasks to be performed by the bridge team and the pilot in making full appraisal of the situation and in navigating the ship safely under all operational conditions*
- *promoting effective and safe bridge resource management*
- *enabling the bridge team and the pilot to have convenient and continuous access to essential information*
- *allowing for expeditious, continuous and effective information processing and decision-making by the bridge team and the pilot*
- *preventing, or minimizing, excessive or unnecessary work and any condition or distractions on the bridge which may cause fatigue or interfere with the vigilance of the bridge team and the pilot*

Ref. SOLAS V/15.1, 15.2, 15.3, 15.5, 15.6

A functional workstation designed in accordance with the established overall operational and ergonomic requirements must provide:

- a sufficient area for performance of the tasks to be carried out by the number of people that may be required to attend
- consoles designed for operations at specific workstations in standing and seated position,
 - o enabling installation of equipment to be within reach from the working position
 - o avoiding obstruction of the view through bridge windows from seated position
- chairs suiting ergonomic requirements for efficient use of installed equipment and maintenance of fields of vision if chairs are to be installed.

B 7.1 The workstation for navigating and manoeuvring should have working positions for route monitoring, change of course and speed and traffic surveillance as close as possible for efficient use by the officer of the watch, but also enabling the tasks to be performed by two navigators in close co-operation.

See Guidance note, Annex A.

B 7.2 Consoles should principally be divided into two areas, when applicable:

- a vertical (slanting) part for location of information displays to be easily readable
- a horizontal part (desktop) for controls, switches and buttons to be within easy reach from the working position

B 7.3 The height of console desktops at the workplaces for navigation, manoeuvring, traffic surveillance and monitoring should enable easy use of equipment required for safe performance of the tasks to be performed from both standing and sitting position.

B 7.3.1 To provide a functional reach from standing position, the height of console desktops above bridge deck surface, equipped with means for operation, should preferably be 800 mm and not less than 750 mm, sloping forward to a height of 950 mm and not less than 900 mm for consoles having a depth of 800 mm from the working position. The height of desktops for frequent use of paper charts for route monitoring from standing position should preferably be 900 mm and not less than 800 mm. To provide easy operation of controls from sitting position, it should be possible to adjust the height of the seat to allow an elbow height 50 mm higher than the console desktop.

Note:

- a. The type of work, means to be used and frequency of use during operations need to be taken into consideration when placing the means in relation to working positions.
- b. The indication of preferable heights does not exclude acceptance of other dimensions when justified, provided other requirements and the overall bridge functionality are not adversely affected.
- c. The height of consoles for route planning in paper charts should preferably be 950 mm and not less than 900 mm.

B 7.4 The console in front of a seated working position should provide sufficient leg room as required to ease the reach of equipment and controls to be used.

See Guidance note, Annex A.

B 7.5 Console configurations and location of displays should aim at providing the user with the information required for performance of main functions at his workstation within a viewing angle from right ahead to 95° to each side.

B 7.6 The consoles forming the front workstations should not be higher than required for efficient use in standing position and should not obstruct the fields of vision over the lower edge windows in front of the workstation from sitting position.

Note:

The height of front workstation consoles not exceeding 1200 mm, may be accepted for installation at a distance of 350 mm or more from windows with a lower ledge of 1000 mm. This console height may also be considered acceptable even if it interferes with the line of sight from an eye height of 1400 mm, providing the height of the chair can be adjusted to compensate for the interference.

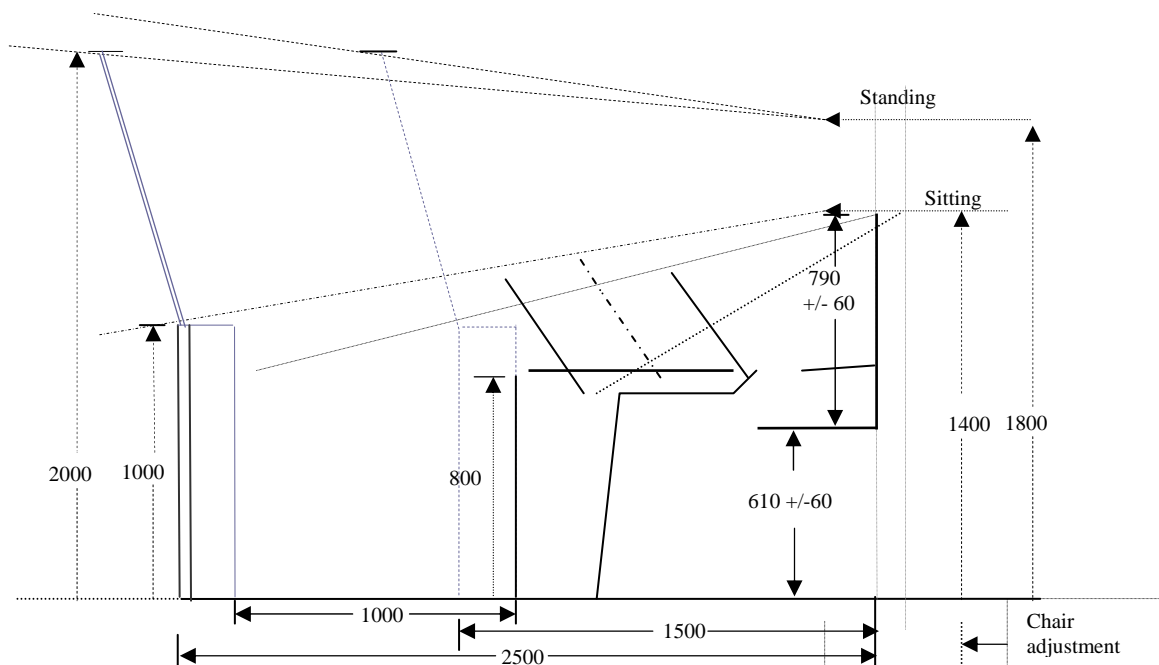

Figure B 7.6 Design principles in relation to lines of sight.

B 7.7 Consoles within the required fields of vision aft of the working position at front workstations should not obstruct the horizontal line of sight from the eye height in seated position.

See Guidance note, Annex A.

B 7.8 The bridge design should permit installation of chairs allowing operations in both seated and standing working positions at dedicated workstations without degrading the required navigation visibility, even if the newbuilding is not to be equipped with chairs at the time of delivery.

Note:

Decision on installation of chairs on the bridge is left to current owners of the ship in consultation with their professional users, taking into consideration operating experience under conditions with high workloads related to the trade and type of the ship, putting focus on the need to mitigate fatigue and promote increased concentration and efficiency.

B 7.9 When a chair is installed at a workstation to be used for operations in both standing and seated position, it should be fastened to rails allowing fore and aft movement of the seat to enable easy reach of equipment when seated and sufficient room to stand in front of the console, preferably 700 mm, when the chair is pushed back. It should be possible to adjust the height of the seat to suit users of different heights for optimum view and reaching distance. Armrests, if provided, should be of fold away type and preferably adjustable in height. The chair should be equipped with an adjustable footrest.

C. DESIGN AND ARRANGEMENT OF NAVIGATIONAL SYSTEMS AND EQUIPMENT

Navigational systems and equipment should be designed with the aim of:

-*presenting the information in a clear and unambiguous manner, using standardized symbols and coding systems for controls and displays*
- *indicating the operational status of automated functions and integrated components, systems and/or sub-systems*
- *minimizing the risk of human error and detecting such error if it occurs, through monitoring and alarm systems, in time for the bridge team and the pilot to take appropriate action*

Ref. SOLAS V/15.3, 15.4, 15.7

and be arranged with the aim of:

- *facilitating the tasks to be performed by the bridge team and the pilot in making full appraisal of the situation and in navigating the ship safely under all operational conditions*
- *enabling the bridge team and the pilot to have convenient and continuous access to essential information*
- *allowing for expeditious, continuous and effective information processing and decision-making by the bridge team and the pilot*

Ref. SOLAS V/15.1, 15.3, 15.5

The basic design of navigation systems and equipment allowed to be used for decision-making related to safety of navigation is governed by functional and technical requirements as well as ergonomic and human-machine interface criteria expressed in the performance standard for General requirements for shipborne radio equipment and electronic navigation aids* and individual IMO equipment performance standards.

Compliance is verified by tests carried out in accordance with appropriate IEC or ISO test standards endorsed by IMO and documented by type approval certificates issued by the flag state Administration. Choice of type approved equipment is considered the responsibility of the owners in consultancy with their professional users.

Selection and arrangement decisions should be made in accordance with the aims stated above, considering the bridge as a whole and ensuring that systems and equipment are located in compliance with design principles and functional requirements set forth in chapter B and C. See Guidance note, Annex A related to principles for selection and arrangement of equipment.

* IMO Resolution A.694 (17)

C 1 Design and quality of navigational systems and equipment

The quality of the human engineering part of the design of equipment and alarm functions is to be determined in performance tests and trials carried out during the equipment type approval process based on the appropriate general and individual IEC test standards. See Annex B, 3.7.1.

All navigational systems and equipment, including integrated systems are subject to testing of system performance after installation. The tests should include accuracy of measurements, failure modes and alarm functions. See A 6.7.

C 1.1 Type approval certificates issued later than 2002 should include evidence of compliance with a general test standard, not inferior to current IEC test requirements*, or equivalent test data to the current version as regards ergonomics and usability.

* IEC 60945 ed.4

See Note C 1.1 in Annex A regarding comparison of test requirements ed.3 and ed.4.

C 1.1.1 Alteration of hardware and software of type approved equipment requires review of the documentation by the type approving authority and may include re-testing to a certain extent, depending on the type of changes.

C 1.2 Navigational equipment and systems offering alternative modes of operation should indicate the actual mode in use. Ref. SOLAS regulation V/19.5.

C 1.3 In case of failure in one part of an integrated navigational system, it should be possible to operate every other individual item of equipment or part of the system separately. Ref. reg. V/19.6.

C 1.4 It should be possible to override or by-pass any automated functions, including the steering system by a single operator action.

Note:

A switch enabling immediate change from automatic to manual steering mode, located together with a steering tiller at the workstation dedicated the officer of the watch will meet the requirement for override of the automatic steering.

C 1.5 Categories of integrated navigation systems – INS – as identified in the IMO performance standard for INS should conform to the relevant requirements of the performance standard.

C 1.6 Each part of the INS should comply with applicable performance standards and requirements adopted by the IMO, including the requirements of the INS performance standards. Parts executing multiple operations should meet the requirements specified for each individual function they can control, monitor or perform.

C 1.7 An integrated bridge system – IBS – should conform to the IMO performance standards for IBS if supporting two or more of the following operations:

- passage execution*
- communications
- machinery control
- loading, discharging and cargo control
- safety and security

* *The function of passage execution in an Integrated Bridge system (IBS) may be performed by an INS which should at least be an INS(B), covered by the relevant IMO performance standards.*

C 2 Arrangement of navigational systems and equipment

The type and number of systems and equipment to be installed on board the newbuilding for the purpose of navigation should at least incorporate the means specified in SOLAS regulation 19. The systems and equipment should be installed and arranged to meet the relevant aims of SOLAS regulation V/15 specified under C.

The aims specified include promotion of bridge resource management (BRM) which should be met by arranging navigational bridge resources (see A 5.4.1) enabling continuous safe and effective bridge team management as defined in A 5.5.

C 2.1 Navigational systems and equipment should be arranged for performance of specific functions at dedicated workstations located for efficient and safe operations by the officer in charge of the navigational watch, the pilot and any composition of the bridge team as required under different operational conditions.

C 2.1.1 All information, controls, facilities and fields of vision required to carry out each of the tasks safely and efficiently should be provided at the corresponding workstations.

C 2.1.2 The relative location of individual equipment and their placement in relation to the distance of reach from the working position at the workstation should be based on:

- Type and range of equipment to be installed - See C 2.1.3
- Equipment relationship with tasks to be performed at the various workstations - See B 1 and C 2.1
- Primary tasks and importance of equipment functions and frequency of use - See B 1

The size and configuration of consoles to be included in workstations (see B 7) should be harmonized with the size of equipment and required space for installations and availability for effective and convenient use.

C 2.1.3 The table C 2.3 at the end of this sub-chapter specifies minimum carriage requirements for ships of different tonnage, the tasks or the purpose the equipment should serve and the type of workstation (WS) at which the equipment is to be used and should be installed. See also table in B 1 specifying equipment in relation to functions and tasks.

See Annex B, 3.7.2 regarding the choice of chart system.

See Note C 2.1.3 in Annex A related to the use of ECDIS and “Introduction of new technology”.

C 2.2 Other means than those specified in C 2.1.3 may be permitted, provided they serve the same functions and are approved in accordance with SOLAS regulation V/18.

C 2.3 Equipment to be installed at the workstations for route monitoring, manoeuvring, traffic surveillance and monitoring should be located for easy use from standing position, whereof means for traffic surveillance, heading and speed adjustments, internal and external communication should be located for easy use also from seated position.

Work in paper charts and manoeuvring requiring the use of lateral thrusters may be performed in standing position only, but controls for thruster systems should be grouped with controls for propulsion and manual steering at the workstation for navigating and manoeuvring.

See Guidance note, Annex A.

Note:

The position for operation of radars and the position at the centre console for harbour manoeuvres are regarded the main working positions at the workstation for navigating and manoeuvring. Figure C 2.3 indicates location of main categories of equipment that should be within reach from the front workstation comprising three workplaces.

Examples of location of primary equipment are shown in Appendix 1 of Annex A.

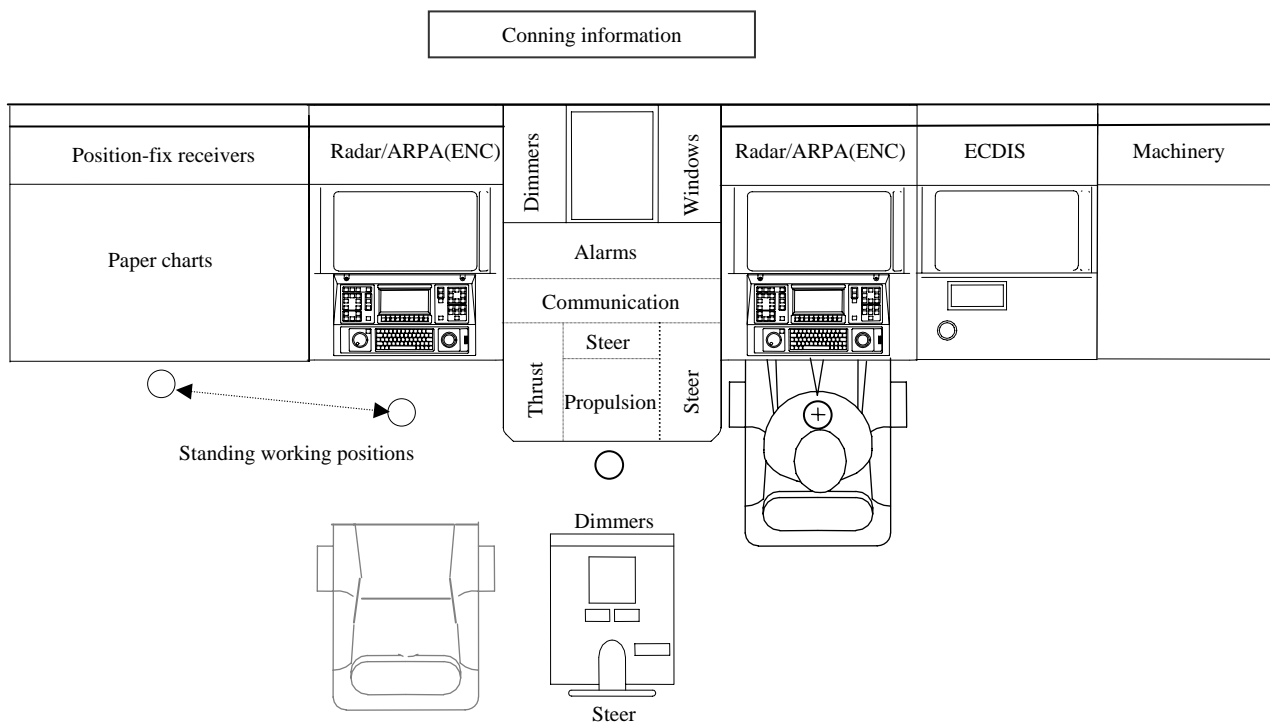

Figure C 2.3 Example of principles for location of main equipment in a centre console and of a general layout of workstation consoles covering the functions of monitoring, including conning as well as navigating and manoeuvring.

(Installation of “chart radars”, ECDIS, conning display and thrusters are optional).

The concept meets user requirements for safe and efficient operations by the officer of the watch and by two officers in close co-operation. Additional consoles may be required for further installation of equipment. A passageway between the centre console and the left radar may be arranged to provide easy access from the workstations to front windows and ease the use of radar and charts for the pilot.

Table C 2.3

Equipment applicable for ships of various sizes (Ref. reg. V/19)				
Task/Purpose	Equipment and means			Remarks
	Equipment	Indicators	Related equipm.	
Applicable for all ships				
Check heading	Magnetic compass ¹			¹ Readable from WS for manual steering
Take optical bearings	Pelorus Means of correcting heading and bearing to true		Magnetic compass	Arc of 360° May be located outside the workstation area.
Route monitoring	GNSS Paper charts Chart table ¹ ECDIS (w/back-up arr ²)			¹ Size sufficient for international paper charts. (at least 1200mm x 850 mm) ² Optional chart system
Surveillance by hearing	Sound reception system	Sound direction		All ships w/ totally enclosed bridge
Communicate heading ¹ - manual - automatic ²	Telephone Gyro repeater			¹ To emergency steering position ² Optional Gyro repeater (located in steering gear comp.)
Applicable for ships ≥ 150 grt				
Spare compass	Interchangeable magnetic compass (or other means)			Stored in bridge area Gyro compass also connected to

Equipment applicable for ships of various sizes (Ref. reg. V/19)				
Equipment and means				
<i>Task/Purpose</i>	<i>Equipment</i>	<i>Indicators</i>	<i>Related equipm.</i>	<i>Remarks</i>
				emergency source of electrical power may be accepted.
Communicate ship/shore	Signalling lamp			Readily available
Applicable for ships ≥ 300 grt				
Traffic surveillance Navigation	Radar with electronic plotting aid (EPA)			9 GHz
Check keel clearance	Echo sounding device			
Check speed & distance	Speed & distance measuring device			Speed through the water
Transmitting heading ¹	Transmitting heading device ²			¹ Trans. to Radar/EPA and AIS ² Gyro required for ships >500 grt
Ship identification, tracking	AIS			Ref. Reg.19.2.4
External communication	VHF telephone			Compulsory (SOLAS Ch IV/4-1 + 17(f))
Applicable for ships ≥ 500 grt				
Determine heading Transmitting heading	Gyro compass	Gyro heading repeater		Trans. to Radar/ATA and AIS
Take bearings – arc 360°		2 gyro bearing repeaters ¹	Main gyro	¹ Location bridge wings
Supply heading info to emergency steering pos.		Gyro heading repeater ¹	Main gyro	¹ Located at emerg. steering position
Manoeuvring - rudder angle - RPM - thruster force + direction - operational mode		Rudder angle		
		RPM/(Pitch)		
		Thruster settings		
		Actual mode of use		When equipment offers diff. modes
Traffic surveillance	ATA ¹		Radar	¹ Replaces EPA
Applicable for ships ≥ 3000 grt				
Traffic surveillance Navigation	Radar with ATA			3GHz or 9GHz (Add a second radar with ATA)
Applicable for ships >10000 grt				
Traffic surveillance	Automatic radar plotting aid (ARPA) ¹		Radar	¹ Replaces one ATA
Automatic steering	Heading or track control system			
Applicable for ships ≥ 50000 grt				
Monitor ship's turn		Rate-of-turn		
Measure speed & dist. forward + athwartship	2-axis speed log			Over ground

Workstation for navigating and manoeuvring				
Main functions: Observation of bridge operations and surrounding environment				
Equipment and means				
Task/Purpose	Equipment	Indicators	Related equip.	Remarks
Traffic surveillance Navigation	Radar with ATA			
Route monitoring	ECDIS			If installed
Give sound signals	Whistle control			
Surveillance by hearing	Sound reception system	Sound direction		All ships w/ totally enclosed bridge
Internal communication	Auto telephone			
External communication	VHF telephone			

Workstation for navigating and manoeuvring				
Main functions: Observation of bridge operations and surrounding environment				
Equipment and means				
Manoeuvring - rudder angle		Rudder angle		Readable also from WS for monitoring + manual steering
- RPM		RPM/(Pitch)		Readable also from WS for monitoring
- Thrusters force + direction		Thruster settings		
- operational mode		Actual mode of use		When equipment offers diff. modes
Automatic steering	Heading or track control system			
Override steering	Changeover switch, steering tiller			
Manual steering	Steering tiller			
Determine heading		Gyro – heading repeater		Also available to WS for monitoring
Monitor time		Clock		
Monitor ship's turn		Rate-of-turn		To be read from WS for monitoring + manual steering
Ship's speed		Speed indicator		
Water depth		Water depth indicator		
Wind force/speed & direction		Wind speed & direction indicator		
Ship's inclination		Inclinometer		
Monitor alarms and warnings	Alarm info system			
Cancel sounds, deduce reason	Accept button			
Watch alarm	Accept button			If applicable

Workstation for monitoring				
Main functions: Observation of bridge operations and surrounding environment –				
Equipment and means				
Task/Purpose	Equipment	Indicators	Related equip.	Remarks
Monitor Steering		Gyro repeater Rudder angle Rate-of-turn	Main gyro	
Monitor Speed Record distance		Speed & distance RPM main engine	Speed log	Pitch if relevant
Monitor time		Clock		
Give sound signals	Whistle control			
Accept watch alarms	Alarm accept button			If installed
Route monitoring*	Paper charts** Chart table** Radar		GNSS/GPS	* Requiring info on ship's position ** or Electronic ECDIS back-up

Internal com. Public address Talk-back	Telephone Control unit/microphone			
External com.	VHF telephone			
Monitoring environment	Ctrls. for window wipers, washing & heating Binoculars			
Documentation	Log-book or equivalent		Conning info	Recording of events

Workstation for Manual steering				
Main functions: Steering in accordance with compass heading and visual marks				
Equipment and means				
<i>Task/Purpose</i>	<i>Equipment</i>	<i>Indicators</i>	<i>Related equip.</i>	<i>Remarks</i>
Operating steering device	Wheel - tiller			
Monitoring compass heading		Compass heading Gyro repeater	Magnetic compass Main gyro	
Communicate bridge wings	Hands free talk-back telephone			

Workstation for Docking				
Main functions: Conning, course alterations, speed changes, mooring operations				
Equipment and means				
<i>Task/Purpose</i>	<i>Equipment</i>	<i>Indicators</i>	<i>Related equip.</i>	<i>Remarks</i>
Determine manoeuvring - Heading - Speed - Steering - Propulsion		Gyro repeater Speed Rudder angle RPM Pitch if relevant	Main gyro Speed log*	* Optional
Manoeuvring operations	Main engine control ¹ Steering control ¹ Thruster control ¹			¹ If installed
Monitor external conditions		Wind speed & direction*		* Optional installation
Communicate wheelhouse (WS for navigating and manoeuvring)	Handsfree talk-back telephone			Open bridge wings: Always. Enclosed bridges: If distance is more than 10 metres
Communicate tugs/pilot boats	VHF (point)			Ref. SOLAS Ch. IV/17(f)

Workstation for planning and documentation				
Main functions: Route planning – documenting ship operations				
Equipment and means				
<i>Task/Purpose</i>	<i>Equipment</i>	<i>Indicators</i>	<i>Related equip.</i>	<i>Remarks</i>
Route planning	GNSS (GPS) Paper chart Chart table Electronic chart			Optional

Workstation for Safety operations				
Main functions: Monitor safety state – Execute relevant measures – Organise operations				
Equipment and means				
Task/Purpose	Equipment	Indicators	Related equip.	Remarks
Display alarm conditions		Remaining alarm indicators not available at WS for navigation/man.		Include acknowledgement of fire and emergency alarms
Provide information + other means for safety management	Remaining safety controls not available at WS for nav./man. Internal telephone			Info about ship's safety systems and contingency plan to be available at the WS

Workstation for communication				
Main functions: GMDSS				
Equipment and means				
Task/Purpose	Equipment	Indicators	Related equip.	Remarks
GMDSS	In relation to trading area			

Conning station (pilot)				
Main functions: External and internal observations for determination of safe course and speed				
Equipment and means				
Task/Purpose	Equipment	Indicators	Related equip.	Remarks
Observe waters, navigational aids, traffic and ship's position in relation to route and waters	Binoculars AIS		Radar AIS pilot plug Nautical chart	Access to radar and updated nautical chart at regular conning position or additional conning station
Observe own ship's heading and steering, speed and propulsion Directing the ship's course and speed.		Gyro repeater Rudder angle Speed RPM Pitch if relevant		Easily readable from the conning position
Effect sound signals	Whistle button			Available at the conning position
Communicate other ships and shore side	VHF telephone			Easy access from working position

C 3 Bridge alarm management

Bridge alarm systems should be designed with the overall aim of:

- *minimizing the risk of human error and detecting such error, if it occurs, through monitoring and alarm systems, in time for the bridge team and the pilot to take appropriate action*

Ref. SOLAS V/15.7

The overall aim includes the aim of:

- enabling the officer on watch to devote full attention to the safe navigation of the ship
- enabling immediate identification of any abnormal situation requiring action to maintain safe navigation of the ship
- avoiding distraction by alarms which require attention but have no direct influence on the safe navigation of the ship and which do not require immediate action to restore or maintain the safe navigation of the ship

Alarms and indicators on the navigating bridge should be minimized and only alarms and indicators required by appropriate IMO Resolutions should be placed on the navigating bridge, unless permitted by the flag administration. Ref. IMO Resolution A.830/3.16.

C 3.1 Alarm systems should be provided, indicating any fault requiring attention and should:

- activate an audible and visual alarm on the navigating bridge for any situation which requires action by or attention of the officer of the watch;
- as far as practicable be designed on the self-monitoring principle.

C 3.2 Means of accepting all alarms on the bridge (both the source of alarm and alarms of other equipment caused by the loss of sensor input) should be provided at the navigating and manoeuvring workstation to avoid distraction. The system should enable immediate identification of the alarm sources without requiring any operator action and enable immediate silencing of the alarms by single operator action. See Guidance note, Annex A.

C 3.3 Acknowledgement of an alarm at either the instrument or an alarm panel should cancel the audible warning at both sources and change the visual alarm from flashing to constant light.

C 3.4 Permanently inhibiting individual alarms should not be possible, but manual suppression of local audible alarms may be accepted when this is clearly and constantly indicated at the equipment and the unit is part of the alarm management system.

Note:

Local audible alarms may be manually suppressed by means of an on/off switch located on or close to the equipment or by other means, e.g. electronically. The off-position should enable suppression of the audible alarm when the equipment is part of a central alarm system and the on-position should engage the local alarm when the equipment serves as a stand-alone unit.

C 3.5 If an alarm channel in a computer-based system is inhibited manually, then this should be clearly indicated by a visual signal.

C 3.6 Audible alarms should be maintained until they are accepted and the visual identification of individual alarms should remain until the fault has been corrected.

Note:

Alarm volumes should be set sufficient to attract attention within the navigating bridge, but not to distract or disorientate. Alarm tones may be different for indication of equipment/system failure, operational warnings and alarms not related to safety of bridge operations respectively. (C 3.1)

C 3.7 Alarm indications should be red, or if on displays, red or otherwise highlighted. If alarm messages are displayed on colour VDUs, the alarm status should remain visible in the event of the failure of one colour of the display system. See Guidance, Annex A.

C 3.8 Alarm systems should be able to indicate more than one fault at the same time, and the acknowledgement of any alarm should not inhibit another alarm, meaning that if an alarm has been acknowledged and a second fault occurs before the first is rectified, the audible and visual alarms are to operate again.

C 3.9 A new alarm condition should be clearly distinguishable from those existing and already acknowledged showing a constant light, by indicating new alarms by a flashing light. See Guidance, Annex A.

C 3.10 Provisions should be made for functional testing of required alarms and indicators.

C 3.11 Alarm systems should be continuously powered and should have an automatic change-over to stand-by power supply, like battery supply or other means, in case of loss of normal power supply.

C 3.11 Failure of the normal or backup power supply of the alarm system should be indicated by an alarm.

C 3.12 Loss of system communication should be indicated by an alarm.

D. BRIDGE PROCEDURES AND OPERATING CONDITIONS

D 1 Bridge team management

Navigating bridges complying with this Recommendation have been designed and arranged with the aim of:

- *facilitating the tasks to be performed by the bridge team and the pilot in making full appraisal of the situation and in navigating the ship safely under all operational conditions*
- *promoting effective and safe bridge resource management*

Ref. SOLAS V/15.1 and 15.2.

Ref. IACS Recommendation, B 2.

D 1.1 Procedures should be established enabling safe operations under all operational conditions by the manning required to master operational situations that may appear. Such procedures should be defined in the Company and ship specific bridge procedures manual and should take account of the requirements of the ISM and STCW Codes and include manning requirements, responsibilities and training requirements for all modes of operation.

D 1.2 The individual bridge workstations meeting the aims of SOLAS regulation 15 arranged and located in accordance with Chapter B, to suit the distribution of functions and tasks to be performed at different operating conditions, may be manned as indicated in the table below for efficient bridge team management by any composition of the team.

See A 5.5.

Bridge team compositions – provision of efficient co-operation

The table shows examples of workstations in use during different operational conditions requiring efficient co-operation by the members of the bridge team in charge. Compliance with STCW requirements by the users when determining the composition of the watch on the bridge is regarded a prerequisite.

Examples of workstations in use during different operational conditions					
Operational conditions	Waters				
	Ocean areas Coastal water	Narrow waters	Pilot waters		Harbours
			General	Confined	
Normal	W1	W1 + W2	W1+W2*	W1+(W3)+W8	W1+W3+W4
Irregular	W1+W2	W1+W2+W3	W1+W2*+W3	W1+W2+W3+W8	W1+W3+W4
Abnormal	W1+W2+W3	W1+W2+W3+W8	W1+W2+W3+W8	W1+W2+W3+W8	W1+W2+W3+W4
Emergency	W1+(W3)+W6 +W7	W1+(W3)+W6 +W7	W1+(W3)+W8 +W6+W7	W1+(W3)+W8 +W6+W7	W1+(W3)+W4 +W6+W7

*When used by the pilot

WS = Workstation

W1 : WS for navigating, manoeuvring (+ traffic surveillance)

W2 : WS for monitoring/conning (if ECDIS installed at workplace for traffic surveillance)

W3 : WS for manual steering

W4 : WS for docking

W5 : WS for planning

W6 : WS for safety operations

W7 : WS for communication

W8 : Conning station

Note:

It is emphasized that the table presents examples of workstations that may be in use during different operational conditions, demonstrating the ability of the workstation concept to promote bridge resource management and enable effective bridge team management. The examples are not meant to govern the factual manning during different operational conditions.

The manning of workstations and the use of a rating for the task of look-out duties in relation to safety of navigation under different conditions and in different areas is the sole responsibility of the master and the officer in charge of the navigational watch and include compliance with STCW Code, Part 3 – Watchkeeping at sea.

It is recognized that the officer in charge of the navigational watch is the master's representative and is primarily responsible at all times for the safe navigation of the ship and for complying with the International SOLAS regulations for Preventing Collisions at Sea as well as with the STCW Code, Part 3-1 – "Principles to be observed in keeping a navigational watch". This part of STCW addresses maintenance of proper Look-out, Watch arrangements, Taking over the watch, Performing the navigational watch and also:

- Watchkeeping under different conditions and in different areas, which includes clear weather, restricted visibility, in hours of darkness, coastal and congested waters, navigation with pilot on board and ship at anchor.

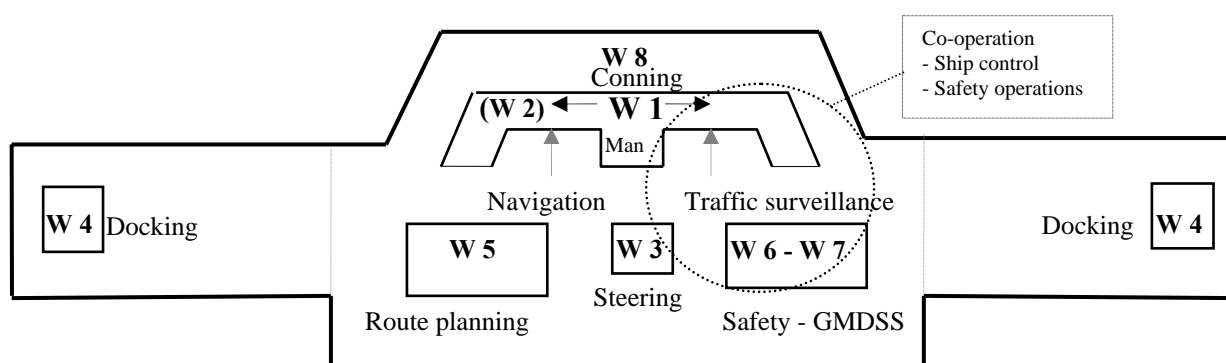

Design principles – Example of location of workstations for effective bridge team management during different operating conditions

The workstation for traffic surveillance and manoeuvring together with the workstation for safety operations and communication form an operational and emergency control centre wherefrom two persons can control the ship and handle emergency events in close co-operation.

D 2 Prevention of operational errors

D 2.1 Established operational procedures and work routines for performance of the navigating bridge functions by the officer of the watch as well as by any number of persons constituting the complement of a bridge team should endeavour of avoiding single operator failure that may affect safety of navigation.

Note:

Bridge team operations – prevention of one person error

When two navigators perform the tasks of navigation in close co-operation it is regarded imperative for safe performance that the navigator in command communicate any intended course and speed changes prior to execution, whether changes are related to route-keeping or collision avoidance, in order to enable the other navigator to verify, interfere or take immediate action as required to avoid mistakes. Any orders given to be executed by another member of the bridge team ought to be repeated to avoid misunderstandings.

Navigating in accordance with the advice of the pilot

It is the responsibility of the captain of the ship that the route has been planned from the port of departure to the port of destination. It is regarded imperative for safe navigation that the use of the planned route is confirmed by the pilot or adjusted by the pilot and accepted by the captain prior to the start of the pilotage. Alternatively, that the pilot's planned route for the waters is accepted by the captain and displayed for the use of navigating officers.

It is regarded imperative for avoidance of misunderstandings and to ensure correct task performance, that advice given by the pilot is repeated by the officer in command prior to execution and when relevant, and also by the member of the bridge team assisting in executing orders.

D 3 Procedures related to SOLAS regulation 24, 25, 27 and 28

D 3.1 The following routines should be included and emphasized in the regular bridge procedures:

- Use of heading and/or track control systems
- Testing of manual steering system after prolonged use of automatic steering system
- Operation of steering gear
- Updating of nautical charts and nautical publications
- Recording of navigational activities

Annex A Guidance and examples relating to requirements of the IACS Recommendation for application of SOLAS V/15 for newbuildings

Guidance notes and examples as to how various requirements may be met by acceptable technical solutions or other remedies are given in a separate document, Annex A to this IACS Recommendation. None of these guidance notes are mandatory in relation to the recommended requirements.

The guidance given does not exclude solutions that fulfil the purpose and intention of the functional requirement providing other requirements and the overall bridge functionality are not adversely affected.

Appendix 1 of Annex A Tasks and related means – Examples of location of main equipment. The title of the Annex indicates the content.

Annex B Facts and principles related to IACS Recommendation for application of SOLAS V/15 for newbuildings

Annex B serves as the interpretation of the content of SOLAS regulation V/15 and intends to provide information about the basis for the development of the Recommendation.

The annex summarizes certain facts that should assist in achieving a common understanding of SOLAS regulation 15 and the framework of the Recommendation. The information given may also make stakeholders more familiar with the approach and platform of the Recommendation based on the content of SOLAS regulation 15 and clarify the reason why certain comments received cannot be regarded applicable in the context of a Recommendation for application of SOLAS V/15 for newbuildings.

Appendix 1 of Annex B clarifies of the content of each aim specified in SOLAS regulation V/15. The appendix clarifies the understanding of each aim and by defining the terms and expressions used also indicates what compliance with the aims should entail.

ANNEX A

Guidance and examples relating to requirements of IACS Recommendation for application of regulation V/15

Introduction.....	3
B 2 Type and range of workstations.....	4
B 3 Working environment.....	4
B 5 Workstation arrangements and required fields of vision.....	4
B 6 Fields of vision and bridge window arrangement.....	5
B 7 Workstation layout, consoles and chair arrangement.....	6
C Design and arrangement of navigational systems and equipment.....	8
C 3 Bridge alarm management.....	10
Appendix 1 to Annex A.....	11
1 Table of tasks and related means for safe operations.....	12
2 Individual workplaces arranged for internal access.....	15
3 Redundant workstations with ECDIS installations.....	15
4 Self-explanatory diagram for location of equipment.....	16

Introduction

Guidance notes and examples as to how various requirements may be met by acceptable technical solutions or other remedies are given in this Annex to IACS Recommendation for application of SOLAS regulation V/15. None of these guidance notes exclude alternative solutions that may fulfil the purpose and intention of the requirement providing other requirements and the overall bridge functionality are not adversely affected.

The guidance given is related to specific requirements, but some are given to exemplify design and arrangement principles. The guidance may be improved and extended based on experience gained from the use of the Recommendation and organized feedback from owners, builders, manufacturers and the users on board the ships.

B 2 Type and range of workstations

B 2.3 Guidance note:

The type of tasks to be performed at the individual workstation and the operating procedures employed may conclude whether a workstation of category A should be of type a) or b).

Workstations of category A, type a) should not include tasks that may prevent the officer in charge of primary bridge functions to leave a workstation for additional functions instantly at any time during operations.

B 3 Working environment

B 3.3 Guidance note:

The sound level measured 1 m from the outlets of air distribution systems should not exceed 60 dB(A).

B 3.6 Guidance note:

Red light should be used for dark adaptation. Fluorescent light is not feasible.

B 3.8 Guidance note:

Deckhead areas above workstations should preferably have a dark colour of matt, anti-gloss type minimizing light reflection. The colour of bridge bulkheads should have a calm and matt appearance.

B 5 Workstation arrangements and required fields of vision

B 5.1 Guidance note:

The workstation for navigating and manoeuvring should be arranged to allow an assisting officer to carry out route monitoring, which may include manual plotting of the ship's position, and course adjustments when required, while the officer in charge concentrates on traffic situations and adjustment of course and speed as required to follow the route and avoid danger of collision.

If a paper chart system, which includes chart table and means for position-fixing, is to be used for route monitoring, the system should be located at the workstation for monitoring. If an electronic chart system (ECDIS) meeting the chart carriage requirements in SOLAS regulations V/19.2.1.4 and 19.2.1.5 is to be used, the back-up arrangement should be located at the workstation for monitoring. The back-up arrangement may be electronic means, paper charts or a combination of both.

The workstation for monitoring, also incorporating the function of route monitoring, should be considered part of a workstation for navigating and manoeuvring. The workplaces for route monitoring and traffic surveillance should be adjacent to enable easy communication and cooperation when two navigators operate the workstation as well as providing the single officer of the watch with a workstation for safe and efficient performance of all the tasks when he is the only navigator on the bridge and is to use both the working position for route monitoring/position-fixing and the working position for traffic surveillance/manoeuvring.

B 5.3.1 Guidance note:

On a bridge with enclosed bridge wings it should be possible to obtain the view of 360° from inside the bridge area by using two positions, one on each side of the workstation for navigating and manoeuvring, not being more than 15 m apart. This guideline may also be applicable for providing the required field of vision within the confines of wheelhouses with a total breadth of more than 18 metres.

B 5.4 Guidance note:

In general, it should be possible to achieve the view required forward of the bow from a sitting eye height of 1400 mm. If this is found unreasonable due to constructional matters related to carriage of cargo, a standing eye height as specified in B 6.3 may be accepted. See also B 7.8.

B 5.7 Guidance note:

The workstation for navigating and manoeuvring should be located on the starboard side close to the centreline if practicable.

B 5.8.1 Guidance note:

Location of bulwarks and bulkheads in a line of sight seen from a seated working position at the front workstations will help reducing the size of internal blind sector. A blind sector covering the view abaft the beam on port side may be considered acceptable for workstations to be used infrequently by the watch officer for short periods at a time (e.g. W.S. for communication).

B 6 Fields of vision and bridge window arrangement**B 6.2 Guidance note:**

The height of the lower edge of windows above the floor surface should not exceed 1000 mm within the required field of vision.

B 6.3 Guidance note:

The height of the upper edge should be at least 2000 mm. A vertical angle of view of not less than 5° above a horizontal line from a standing eye height should be provided.

B 6.4 Guidance note:

The division between windowpanes within the required field of vision should not exceed 150 mm. If stiffeners are used, divisions should not exceed 100 mm in width, if practicable, and 120 mm in depth. The width of windowpanes within the field of vision required for traffic surveillance should not be less than 1200 mm in order to limit the number of stiffeners.

B 7 Workstation layout, consoles and chair arrangement

B 7.1 Guidance note:

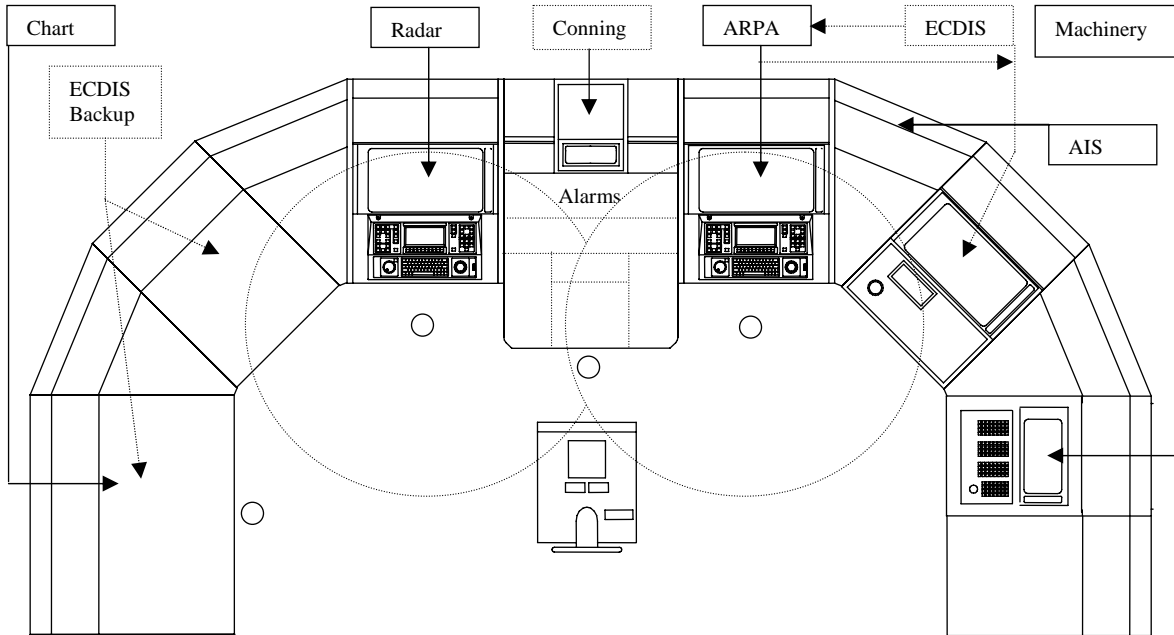

Figure B 7.1 – A: Workstation layout which may include ECDIS with combined electronic and paper chart backup arrangement as well as conning information display for visual monitoring of INS functions.

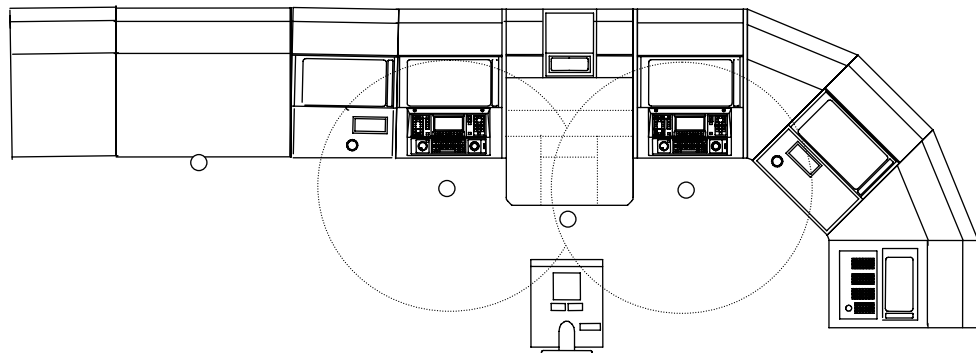

Figure B 7.1 – B: A modified workstation configuration, based on same principles as shown in Figure A. May suit wheelhouses with limited depth (longitudinal distance between front and rear bulkheads).

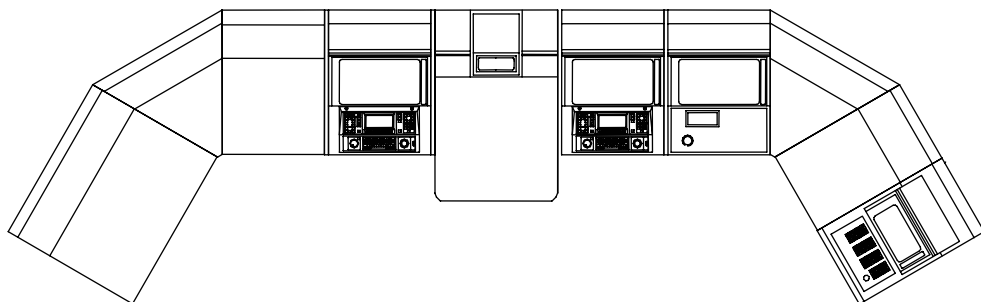

Figure B 7.1 – C: A modified version of figure B.

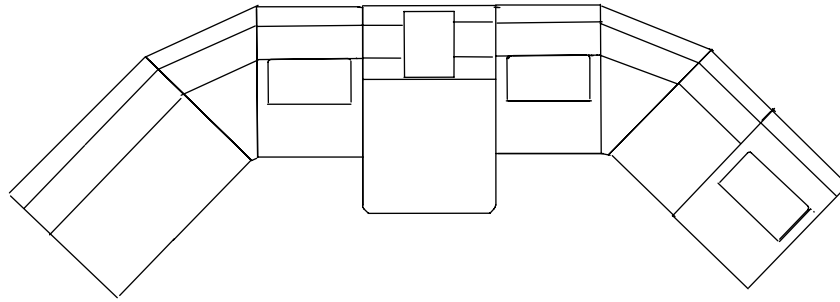
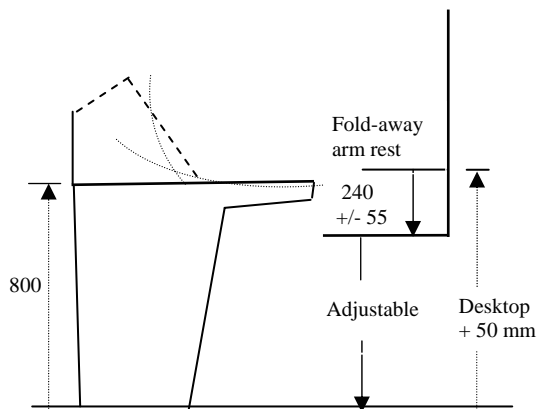

Figure B 7.1 – D: Design principles similar to figure C, but without electronic chart installations. Includes space for conning information display and machinery monitoring system.

B 7.3 Guidance note:

To provide a functional reach from standing position, the height of console desktops above bridge deck surface should be 800 mm and not less than 750 mm. The sitting height is governed by the elbow height in relation to console desktop.



To provide a functional reach of equipment and easy operation of controls from sitting position, the elbow height of the operator should preferably be 50 mm higher than the console desktop and not less than the height of the desktop.

To provide the elbow height required for persons of different size and build in relation to the console desktop, it should be possible to adjust the height of the seat to allow an elbow height of 240 mm +/- 55 mm above the seat. It should be possible to adjust chair armrests accordingly, if installed, and to fold the armrests away.

B 7.4 Guidance note:

The leg room required is governed by the seated working position suiting the user with regard to reach and effective operation of the equipment installed in the consoles, meaning the position of the chair in relation to the front of the console. The reach may be related to equipment installed in both front and side consoles. See Figure C 2.3.

B 7.7 Guidance note:

The height of the consoles should be 100 mm lower than the horizontal line of sight and should not exceed 1300 mm.

C. Design and arrangement of navigational systems and equipment

Guidance note:

Principles for selection and arrangement of navigational systems and equipment in accordance with applicable aims of SOLAS V/15.

Particularly important topics include, but are not restricted to, the following:

- a. The design and arrangement of equipment on the bridge, particularly the display of user inputs and commands, should help to prevent single person error by facilitating monitoring and cross checks between members of the bridge team and pilot.
- b. The design and arrangement of equipment on the bridge should facilitate validation of electronic information by actual observation of the surrounding environment and the use of any means available.
- c. The design and arrangement of equipment on the bridge should provide convenient and continuous access to essential information for both the bridge team and pilot.
- d. The current operating modes should at all times be clearly indicated to the bridge team and pilot. Indications of failure modes should be presented in a clear and unambiguous manner to enable the bridge team and pilot to understand the nature of the failure and its consequences.
- e. Information (including control status) should be presented consistently within and between different sub-systems and items of equipment. Standardized symbols and coding should be used.
- f. The functionality and automation to be provided should take account of the likely workload of the bridge team and pilot. This would typically influence selection of items including but not restricted to form of AIS implementation, ECDIS, autopilot functionality, bridge wing consoles, radar capability, alarm systems, dimmers.
- g. Confirmation that the bridge design, equipment selection and arrangement, and the procedures meet the aims of SOLAS V/15 should be sought from representative users.

C 1.1 Note:

IEC general test standard for navigational systems and equipment

It should be noted that the current edition of the General test requirements, IEC 60945 ed.4, 2002, extends the detail of operational tests particularly for equipment which is operated through software menus. The layout of the Clause on minimum performance requirements has been changed to give a better grouping of ergonomics, hardware and software requirements. The EMC tests have been revised with the frequency range having been extended from 1 GHz to 2 GHz.

A comparison of the test requirements in the third and fourth editions is given in annex G of IEC 60945 to assist manufacturers and test houses in the use of the new edition, and may be informative to ship owners. The fourth edition cancels and replaces the third edition published in 1996 and constitutes a technical revision.

C 2.1.3 Note:

In order to meet relevant aims of Regulation 15, all ships should carry ECDIS with electronic back-up arrangement, provided ENC (electronic nautical charts) are available. The use of ECDIS enhances the safety and efficiency of route planning and monitoring thereby minimizing the danger of grounding, reducing workloads and increasing the quality of traffic surveillance. Because the carriage of electronic chart system is optional in regulation 19, it is left to the flag Administration to decide if the carriage should be regarded mandatory for their ships.

When using chart systems with automatic positioning of the ship in the chart, it is regarded imperative for safety of navigation that the navigation procedures and work routines specify the importance of controlling the ship's position by other independent means.

Introduction of new technology for the purpose of enhancing safety of navigation

The requirement for a ship to carry charts is contained in Regulation 19, supported by Regulations 2, 9 and 27. Regulation 19 states that the chart carriage requirement may be met by the use of an Electronic Chart and Display and Information System (ECDIS) supported by back-up arrangement. In this respect, there are some key items to be aware of when a ship is to satisfy the chart carriage requirement by electronic means:

- 1) ECDIS equipment, specified in Resolutions A.817 (19), MSC 64 (67) and MSC 86 (70), must be type approved.
- 2) Charts to be used are Electronic Navigational Charts (ENC), which conform to standards defined by the International Hydrographic Organization (IHO).
- 3) The ECDIS Performance Standard permits ECDIS to operate optionally in the Raster Chart Display System (RCDS) mode of operation using Raster Navigational Charts (RNC). The RCDS mode of operation is only to be used for those areas where ENCs have not been published on the condition that the ECDIS is "used together with an appropriate folio of up-to-date paper charts".
- 4) ENC are superior to RNC and therefore of vital importance to safe navigation, especially in critical and complex waters. (See SN/Circ.207) However, individual Maritime States (to be identified) may accept the use of RNC for the purposes of Safety of Navigation within less complex waters under their jurisdiction for the time being until ENCs are available.
- 5) The ECDIS Performance Standard specifies the requirements for back-up arrangements but does not indicate which solutions may meet those requirements. Regulation 19 states that an "appropriate folio of paper charts" may be used.
- 6) The requirements for ECDIS back-up arrangements state that adequate independent back-up arrangements shall include facilities enabling a safe take-over of the ECDIS functions in order to ensure that an ECDIS failure does not result in a critical situation. In order to meet this requirement when paper charts are used for the purpose of ECDIS back-up arrangement, the following should be included in the navigation procedures and work routines:
 - The planned route is to be inserted in the paper chart and the ship's position needs be updated regularly as required to enable an instant take-over of ECDIS functions, allowing a safe continuation of the navigation.

C 2.3 Guidance note:

In this workplace configuration (see Figure 2.3), a long centre console separating the front workstations (see Appendix 1, Annex A) may be accepted if the official chart system in use is an ECDIS installed at the workstation for navigating and manoeuvring (starboard), providing propulsion and manual steering (tiller) are within reach from the working position at the port workstation with backup chart system.

C 3 Bridge alarm management

C 3.2 Guidance note:

A bridge management system should separate alarms that affect safety of navigation and alarms that do not influence safety of navigation in two groups.

The group of alarms related to safety of navigation should incorporate all system alarms, equipment alarms and operational warnings that are critical to safety of navigation, including the detection of:

- operator disability (if detection system is installed)
- danger of collision
- heading deviations
- deviations from the route
- danger of grounding
- propulsion failure
- steering gear failure

Essential equipment and systems to be incorporated in such an alarm system should include:

- bridge navigational watch alarm system - BNWAS (if installed)
- heading information system
- heading / track control system
- position-fixing systems
- electronic chart system, if installed
- radar with electronic target plotting functions
- relevant machinery alarms for early warning

All groups of bridge alarms and warnings should preferably be centralised in a common panel or screen at the workstation for navigation and manoeuvring.

C 3.6 Guidance note:

The following method of indication should be applied:

- 1) Active alarm status:
Red, blinking and audible
- 2) Active alarm status acknowledged:
Red, static (cancelling the audible alarm)
- 3) Active warning message - not critical:
Yellow, static (may be accompanied by a short audible attention signal)
- 4) Normal condition:
No light (indication of a safe situation)

C 3.9 Guidance note:

In colour graphic systems, colours should not be used as the only means to distinguish between the status of alarms and warnings.

Appendix 1 to Annex A

TASKS AND RELATED MEANS EXAMPLES OF LOCATION OF MAIN EQUIPMENT

at workstations to be used by
the officer in charge of the navigational watch
and
by two officers in close co-operation

List of content

1	Table of tasks and related means for safe operations.....	12
2	Individual workplaces arranged for internal access.....	15
3	Redundant workstations with ECDIS installations.....	15
4	Self-explanatory diagram for location of equipment.....	16

1 Table of tasks and related means for safe operations

Tasks and Means - Location					
Function/Tasks to be performed	Equipment to be operated	L	Information to be viewed	L	Remarks
Navigation – Grounding avoidance					L = Reference for location in console
Planning					
Plan route prior to departure	Paper chart/table Nautical publications	N1			
Alter route while under way	DGPS	N2	GPS Position		
	ECDIS*	N3			* Optional install.
	ECDIS backup**	N4			** If replacing paper
In Transit					
Monitor route-keeping: - Determine position by bearings - Read position on display - Plot position	Pelorus/gyro repeater* Radar DGPS Paper chart/table	N5 N6 N2 N1			* One on each bridge wing (360°) and also at workstation if feasible
- Automatic determination and plotting of ship's position	ECDIS	N3			Optional installation
Monitor shallow water areas	Echo Sounder system	N7	Water depth	DN7	(Anchoring)
Monitor performance of automatic functions	Conning display	N8*	Conning info route-keeping		* If provided
Maintain route/alter course by - manual steering - using autopilot - automatic route-keeping	Manual steering tiller** Heading ctrl. system Track ctrl. system* (ECDIS)	M1 M2 M2*			* Alternative to head ctrl. ** Alternative: M4 - Helmsman
Monitor heading, turn, rudder angle, speed, propulsion	Conning display*	N8*	Heading - rudder angle - rate-of-turn - RPM, Pitch - speed indicator	D0 D1 D2 D3 D4	* If provided
Give sound signals	Whistle ctrl.	C1			Fog - traffic
Receive sound signals	Sound reception syst.	C2	Loudspeakers		Enclosed bridge
Effect internal communication	Intercom (auto tlp.)	C3			
Effect external comm.	VHF	C4			Related to nav.
Receive/send distress message	GMDSS remote ctrl.	C5			
Monitor/Take action: - operational warnings - system failure alarms - ship's safety state	Nav Alarm panel Alarm system panels	A1			Not specified

Traffic surveillance – Collision avoidance					
Detect floating targets Analyse traffic situations Observe visually	Radar with ETP* (may incl. AIS) Binoculars Window wiper -cleaning heating ctrl.	T1	Targets relative position, course, speed Expected passing distance/time		* Electronic target plotting
Decide on collision avoidance measures	AIS (automatic identification system)	T2	Target true position, course, speed		
Manoeuvring		M			(For route-keeping)
Change steering mode	Steering mode switch	M0			
Alter heading	Heading ctrl.	M2	Heading (Gyro)	DM1	
Observe rudder angle			Rudder angle	DM2	
Override steering*	Override/steering ctrl.	M1			*Officer
Manual steering*		M4			*Helmsman
Change speed	Propulsion ctrl.	M3	RPM/Pitch	DM4	
Give sound signals	Whistle ctrl.	C1			
Receive sound signals	Sound reception syst.	C2	Loudspeaker	IC5	Enclosed bridges
Navigate back to route	Paper chart/table DGPS	N1 N2			

Maintain track of traffic	Radar with route and navigable waters	N6			
	ECDIS*	N3			* May replace paper
Harbour manoeuvring	Thruster*	M5			* If provided
Anchoring/ manoeuvring					
Steering	Manual steering ctr.	M4*	Heading	D0	* Alternative: M1 Front workstations / docking station. Displayed Info to be provided for Pilots.
Adjust speed	Propulsion ctr.	M3	Rudder angle	D1	
Adjust ship's heading	(Thruster ctrl.)	M5	RPM/Pitch	D3	
Positioning	Radar	N6	Water depth	D5	
(Identify anchor position)	Chart	N1			
	DGPS	N2			
Observe ship's safety state					
Monitor alarm conditions:					
- Navigation alarms	Main alarm panel W/indicators and acceptance button		Alarm list		
Equip. & system failures					
Operational warnings					
- Machinery alarms	Alarm panel				
- Cargo alarms	Alarm panel				
- Fire alarm	Fire alarm panel				

Conning station					
Determine & direct course and speed in relation to waters and traffic					
Monitor:					
- heading			Gyro repeater	D0	Digital, readable 2 m
- rudder angle			Rudder angle	D1	
- rate-of-turn			RoT indicator	D2	
- propulsion			RPM/Pitch	D3	
- speed			Speed log	D4	
- water depth			Echo sounder display	D5	Anchoring
Give sound signals	Whistle ctrl. button	C1			
Effect communication	VHF				Available for pilot

Manual steering					
Maintain, adjust, alter heading according to order	Steering ctrl. Intercom (Command)	M4 C6	Gyro repeater Magn. comp. Rudder angle Rate-of-turn		(Rating)

Safety operations*					
* Workstation not indicated on drawing					
Take action on alarm condition:					
- analyse situation	Manuals - Drawings		Computer based info		
- consult plans and drawings					
- observe ship's external operational situation					Cooperation with navigating officer
- organize and execute measures by communication	Intercom (UHF) Emergency stop				
- check status of ventilation system					
Monitor development of alarm conditions					
- Cargo alarms	Alarm panel				
- Fire detection & alarms	Fire detection and alarm panel				
- Gas & smoke detection					

External communication					
Distress - weather - safety	GMDSS station	C7			As required (Area)
Determine weather conditions					
Consider nav. warnings	Navtex receiver	C8			
Public correspondence	Additional equipment				Specified by owners

Docking operations (bridge wings*)	* Bridge wing workstations are not indicated on drawing				
Directing steering	Intercom (command)	C6	Heading Rudder angle	D0 D1	
Directing speed	Intercom (command)	C6	RPM/Pitch	D3	
Giving sound signals	Whistle control button	C1			
Receiving sound signals	Sound reception syst.	C2	Loudspeaker		Enclosed bridge
Perform manoeuvring – bridge wings*	Steering Prop. ctrls Thruster ctrl.	M4 M3 M5			* Installations not mandatory

Indications on drawings

N1	Paper chart table	M0	Steering mode switch	C1	Whistle ctrl.
N2	GPS	M1	Override/steering tiller	C2	Sound reception syst.
N3	ECDIS	M2	Auto heading ctrl./track ctrl.*	C3	Intercom (auto tlph.)
N4	ECDIS back-up	M3	Propulsion ctr.	C4	VHF
N5	Pelorus/gyro repeater	M4	Main manual steering ctrl.	C5	GMDSS remote ctrl.
N6	Radar	M5	Thruster ctrl	C6	Internal command com. syst.
N7	Echo sounder				
N8	Conning display				

A1	Panel –warnings/alarms	D0	Heading display/gyro repeater		
A2	Machinery systems	D1	Rudder angle indicator		
T1	Radar/ARPA	D2	Rate-of-Turn indicator		
T1+	Radar/ARPA w/ENC	D3	RPM/Pitch indicator		
T2	AIS	D4	Speed indicator		
T3	Window wipers	D5	Echo sounder display		

- N** : Means for Navigation
M : Means for Manoeuvring
C : Means for Communication
A : Alarm systems
T : Means for Traffic surveillance
D : Information - indicators/displays

HSV: SOLAS High Speed Vessels
 OSV: Offshore Supply Vessels
 ENC: Electronic Nautical Chart

2 Individual workplaces arranged for internal access

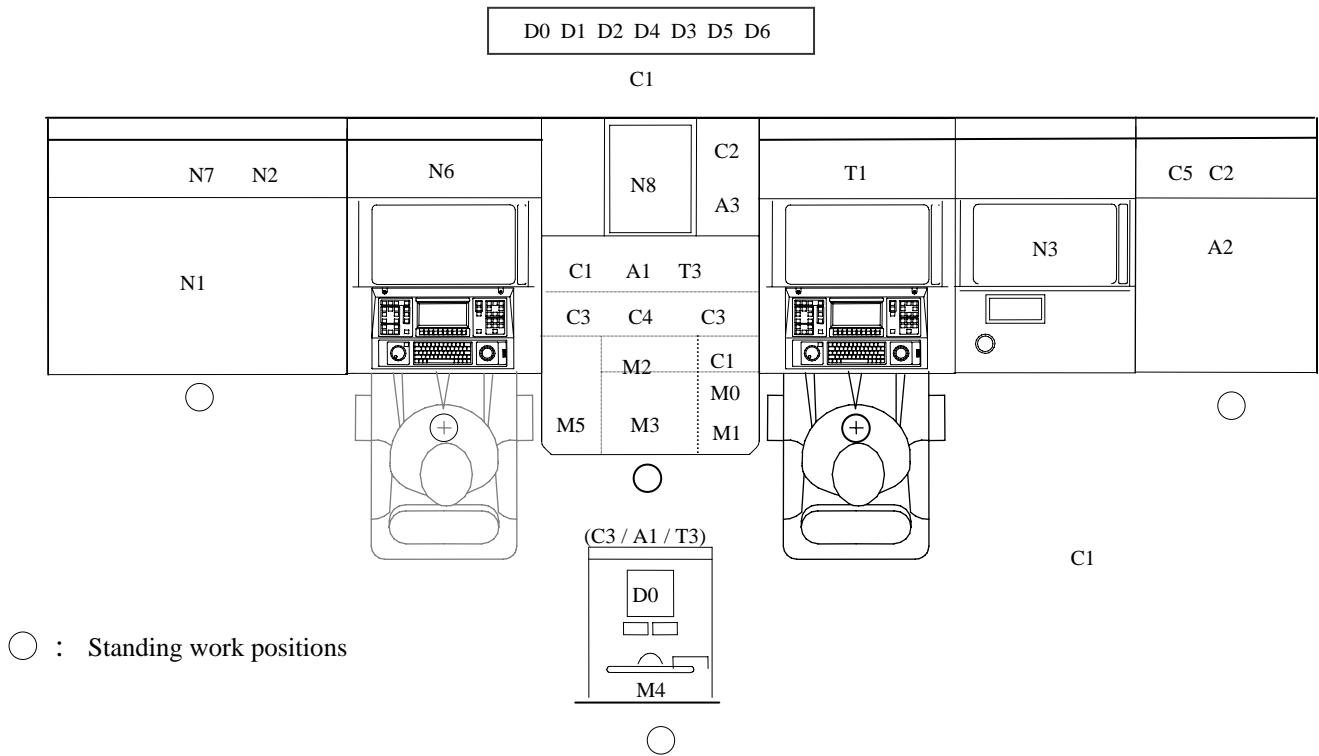

Example of location of main equipment in a centre console. Easy access to manoeuvring functions in standing position. Ref. clause C 3.3

3 Redundant workstations with ECDIS installations

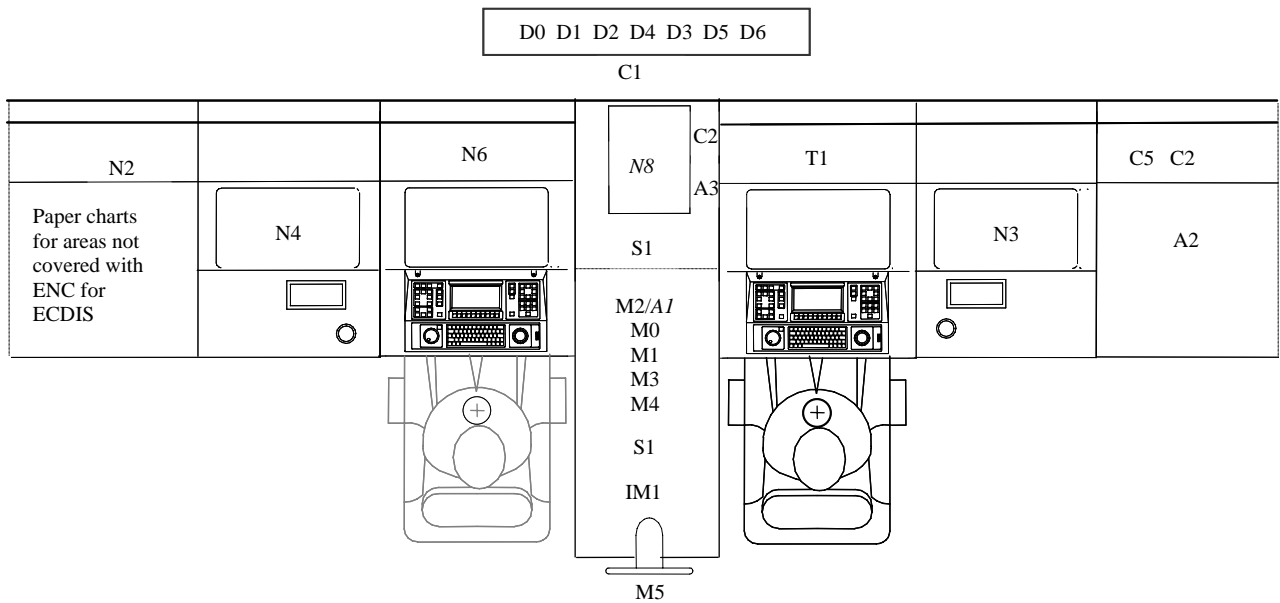

When all the means required for performance of navigation, traffic surveillance and manoeuvring are available at each of the two workplaces, a long centre console dividing the workstation may be used.

4 Self-explanatory diagram for location of equipment

Location in relation to reach for task performance in seated position.

The criteria should include the individual importance of equipment, harmonization of the information needed and means for the actions to be taken together with the frequency of use.

(HSV / OSV)

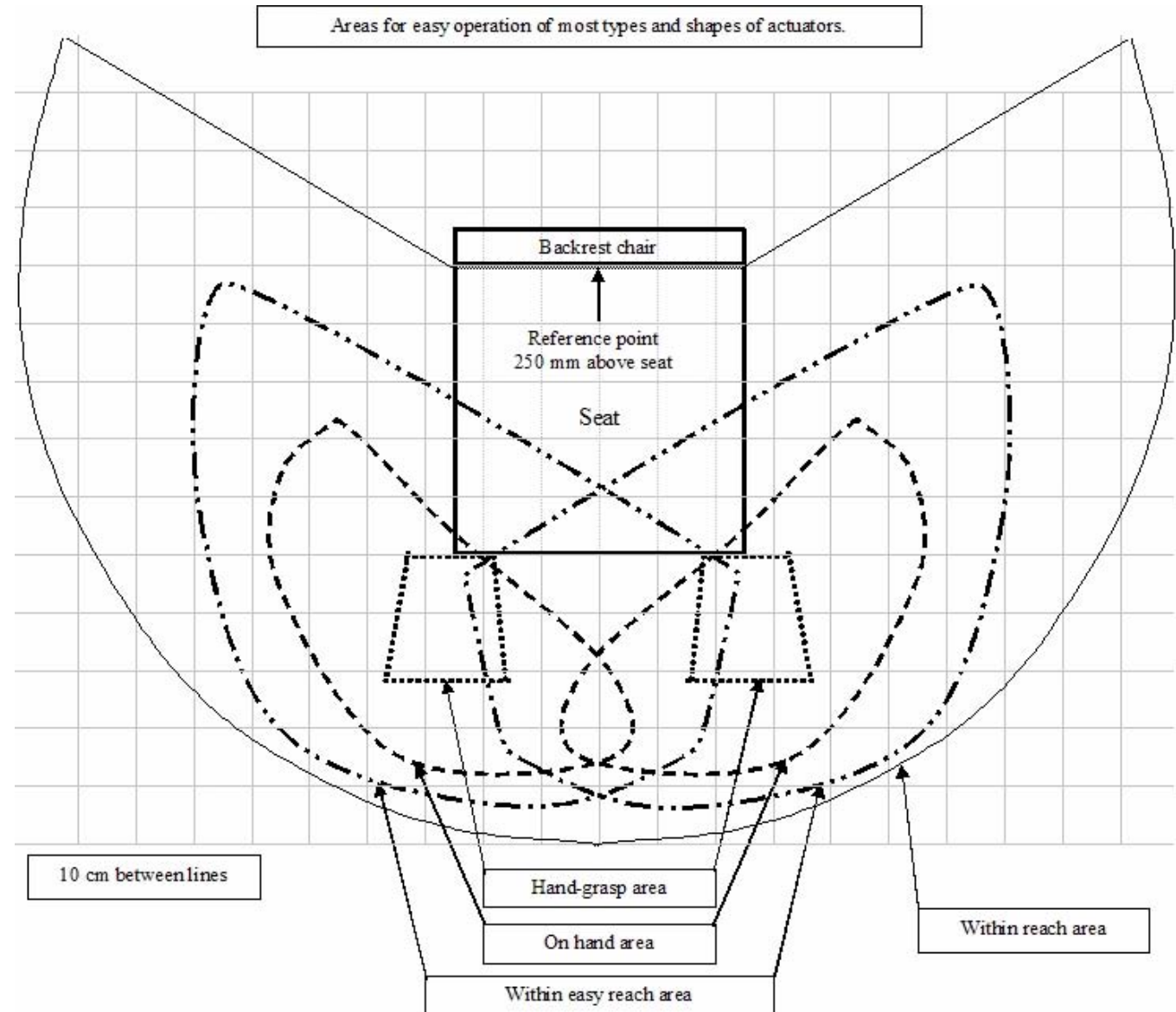

ANNEX B

SOLAS Regulation V/15

Facts and principles related to the IACS Recommendation

Facts and Principles Related To IACS Recommendation For Application Of SOLAS Regulation V/15 For Newbuildings.....	3
1 HOW TO COMPLY IN RESPONSE TO THE PRINCIPLES AND AIMS OF SOLAS REGULATION V/15.....	3
1.1 SOLAS regulation V/15 and the complexity of interpretation.....	3
1.2 IMO considerations.....	4
2 THE CONCERN OF THE RECOMMENDATION AND THE APPROACH.....	4
2.1 Decisions to be made and aims to be met by individual regulations.....	5
3 FACTS AND PRINCIPLES GOVERNING DECISIONS AND SOLUTIONS.....	7
3.1 Bridge watch resources and design principles.....	7
3.1.1 Number of certified navigators on board – Bridge watch duty intervals.....	7
3.1.2 Manning of the bridge – Design criteria.....	7
3.1.3 Manning of the bridge for safe navigation – Responsibility of the bridge management.....	8
3.1.4 Bridge design criteria – Overall requirements.....	8
3.2 User-oriented regulations.....	8
3.3 Bridge functions.....	8
3.3.1 Task performance.....	9
3.4 The workstation concept.....	9
3.4.1 The workstation concept to be used on all regulation 15 bridges.....	9
3.5 Responsibility of providing workplaces for safe and efficient operations.....	9
3.6 Competence, procedures and BRM - Responsibility of the management.....	9
3.7 Use of type approved equipment - Responsibility of the user.....	10
3.7.1 Selection of system configurations and equipment for installation.....	10
3.7.2 The authority of IACS on behalf of flag state Administrations.....	10
3.8 Responsibility of verification – Unified and predictable approval procedures.....	11
3.9 Compliance at the time of delivery of the ship - Responsibility of the shipbuilder.....	11
4 CONCLUSIVE NOTE.....	11
4.1 Bridge team qualifications, training and operational procedures.....	12
Appendix 1 to Annex B - Clarification of the Content of Each Aim.....	14
The Aims of SOLAS Regulation V/15.....	15
AIM 15.1.....	15
AIM 15.2.....	17
AIM 15.3.....	17
AIM 15.4.....	18
AIM 15.5.....	19
AIM 15.6.....	20
AIM 15.7.....	20

SOLAS Regulation V/15**FACTS AND PRINCIPLES RELATED TO IACS RECOMMENDATION FOR APPLICATION OF SOLAS REGULATION V/15 FOR NEWBUILDINGS**

This document intends to provide information about the basis for the development of the Recommendation and summarizes certain facts that should assist in achieving a common understanding of regulation 15 and the framework of the Recommendation. The information given may also make stakeholders more familiar with the approach and platform of the Recommendation based on the content of regulation 15 and clarify the reason why certain comments received cannot be regarded applicable in the context of this Recommendation.

1. HOW TO COMPLY IN RESPONSE TO THE PRINCIPLES AND AIMS OF SOLAS REGULATION V/15

Application of regulation 15 already in force will improve working conditions for the users responsible for the safe and efficient performance of navigation functions, thus reducing operational failures. A common implementation of the regulation has however proved difficult due to the lack of a suitable instrument for verifying compliance with the regulation.

The IACS Recommendation has been developed to serve as a common reference for verification of compliance with regulation V/15 at the time of delivery of the newbuilding. The Recommendation is to be used for verification of compliance with regulation 15 and related regulations.

The use of the Recommendation implies that requirements of the SOLAS regulations V/19, 22, 24, 25, 27 and 28 will be met with due regard to applicable aims of regulation 15 for the benefit of the users. Furthermore, the use of the Recommendation should ascertain that shipbuilders and owners can expect a unified, consistent and predictable approval process.

The Recommendation relates to the IMO's regulatory regime of verifying compliance with regulations by documentation, survey and testing required to enable flag state Administrations to issue the certificates as required for legally allowing the ship to be put in service.

It is assumed that relevant IMO survey schemes are reviewed as required to ascertain that the regulation V/15 level of functionality and quality of the bridge system documented at the delivery of the ship will be maintained throughout the lifetime of the ship.

1.1 Regulation V/15 and the complexity of interpretation

Regulation V/15 requires consideration of 7 specific aims when decisions are made for applying the requirements of 6 individual regulations within 4 specific areas affecting the navigation bridge system and safety of navigation. Furthermore, the Recommendation should serve as a reference for verification of compliance with the complete regulation, as required at the delivery of newbuildings of all sizes, including types of ships that may be navigated at service speeds up to 30 knots.

The complexity indicates that for the purpose of serving as platform for the requirements of the Recommendation, the interpretation part needs to focus on the content of SOLAS regulation V/15 and the regulatory framework of the Recommendation, as well as what compliance with the aims may entail.

A common understanding of SOLAS regulation V/15 and its effect on regulations to be complied with prior to the ship being put in service is regarded essential for a common acceptance of the Recommendation and a successful implementation of the regulation. Some of the comments on the draft Recommendation revealed that there exists deviating understanding of the content of regulation 15 and what compliance with the regulation should entail.

Any dispute on the interpretation of SOLAS regulation V/15 or requirements of the Recommendation should point to deviating understanding of the relevant part(s) of the content of this Annex, clarifying the consequences for appropriate compliance with the regulations of concern prior to delivery of the ship and the effect on safety of navigation.

1.2 IMO considerations

At MSC 78, the working group on the Human Element considered the IACS Unified Interpretation (UI) SC 181 as contained in annex to document MSC 78/11.3. (The substance of the content of the UI discussed at MSC 78 is similar to the content of the IACS Recommendation for application of SOLAS regulation V/15).

Quote: “The group expressed appreciation to IACS for its efforts in addressing this difficult issue and agreed that the UI developed by IACS sets forth a set of requirements for the compliance with the principles and aims of SOLAS regulations V/15 relating to bridge design, design and arrangement of navigational systems and equipment and bridge procedures when applying the requirements of SOLAS regulations V/19, 22, 24, 25, 27 and 28, and that it would be a useful instrument to be applied for the purpose of survey and certification until the time of delivery of the ship.”

In response to the task of developing an appropriate instrument to be used to demonstrate compliance with SOLAS regulation V/15, the group stated that it felt there was no need to develop a new instrument.

2. THE CONCERN OF THE RECOMMENDATION AND THE APPROACH

The concern of the Recommendation is to ensure that all decisions which are made for the purpose of applying the requirements of SOLAS regulations V/19, 22, 24, 25, 27 and 28 and which affect bridge design, (design* and) arrangement of navigational systems and equipment on the bridge and bridge procedures** are taken in accordance with the applicable aims of SOLAS regulation V/15. Furthermore, that the regulations are complied with prior to the ship is put in service.

* Design of navigational systems and equipment, which is also addressed by SOLAS regulation V/15, is governed by IMO performance standards. Verification of compliance with aims related to design of systems and equipment (the last part of aim SOLAS regulation V/15.3 and the aim of SOLAS regulation V/15.4) is assumed to take place as part of the test program to be conducted for type approval by flag state Administrations.

** In general, it is regarded the responsibility of the owners and the bridge management to establish and implement bridge procedures as required by SOLAS regulation V and the STCW Code to the satisfaction of the ISM Code. Certain procedures need to be completed and available on the bridge prior to the ship is put in service.

In order to cater appropriately for the concern stated above and at the same time provide sufficient transparency to enable review by third parties, the Recommendation has been developed based on an analytical approach. (See Overview diagram, last page of this Annex)

The approach includes the tasks of:

- Identifying decisions that need to be made for the purpose of applying the requirements of each of the regulations addressed by SOLAS regulation V/15 (Annex B, 2.1);
- Defining and clarifying the expressions and text of each aim in order to establish a common understanding of the content and purpose of the individual aims, enabling a unified approach in meeting the aims as specified in the regulation (Appendix 1 of Annex B);
- Identifying the scope and purpose of the guidelines and standards referred to by regulation 15 for application of SOLAS regulations V/19, 22, 24, 25, 27 and 28;
- Identifying the purpose and main requirements of the various regulations to be applied, the areas affected by the individual regulation, the aims of regulation 15 relevant for each of the individual regulations and the corresponding guidelines of MSC/Circ.982.

2.1 Decisions to be made and aims to be met by individual regulations

The first step of the development, commencing with identifying the main decisions that need to be made for the purpose of applying the requirements of the individual regulations and indicating specific aims to be applied, is summarized below:

- ❖ Main decisions in the context of *SOLAS regulation V/19* are related to provision of a minimum range of navigational systems and equipment specified for various ship sizes and the installation on the bridge as required at defined workplaces for the use of the officer of the watch, the bridge team and the pilot. The decisions include determination of:
 - system configurations and equipment to be selected for installation
 - the range of workstations required for performance of all bridge functions
 - location of systems and equipment at dedicated workstations in relation to the function(s) to be performed
 - location of workstations in relation to
 - SOLAS regulation V/22 requirements, safeguarding provision of the field of vision required for visual observations
 - inter-relationship required for efficient bridge team operations

The decisions to be made in this context affect bridge design and arrangement of navigational systems and equipment, and should be taken with the aims as specified in .1, .2, .3*, .5, .6 and .7 of regulation V/15.

* First part

- ❖ Main decisions in the context of *SOLAS regulation V/22* are related to provision of the view through windows and fields of vision as required from defined workplaces on the bridge for the use of the officer in charge of the navigational watch, the bridge team and the pilot. The decisions include determination of:

- location, height and configuration of the bridge (wheelhouse), placing of permanent structures outside the wheelhouse, safeguarding optimum view as required from different workstations and avoiding excessive blind sectors
- location of windows and workstations in relation to provision of fields of vision and avoidance of blind sectors caused by permanent structures outside the wheelhouse
- the type and height of cargo to be carried on deck without obstructing the view from bridge workstations

The decisions to be made in this context affect bridge design and arrangement of navigational systems and equipment, and should be taken with the aims as specified in .1, .2, .3* and .5 of SOLAS regulation V/15.

Harmonization of decisions to be made for the purpose of applying SOLAS regulations V/19 and 22 is needed in order to safeguard that common aims are fully met by both regulations for the benefit of the user and safety of navigation.

* The aim apparently addresses information to be presented by equipment. However, convenient and continuous access to information provided by the view through windows within the required fields of vision is regarded equally important.

- ❖ Main decisions in the context of **SOLAS regulation V/24** is related to the use of heading and track control systems and include consideration of:

- means for establishing immediate manual control of the ship's steering system when the track control system is in use
- routines for safeguarding that a qualified helmsperson is instantly available at all times
- routines for change-over from automatic to manual steering and vice versa
- routines for testing of the manual steering before entering areas where it might be used

The decisions to be made in this context affect bridge design and arrangement of navigational systems and equipment and procedures, and should be taken with the aims as specified in .1 and .2 of regulation V/15.

- ❖ Main decision in the context of **SOLAS regulation V/25** is related to operation of the steering and includes determination of:

- routines for safeguarding that more than one steering gear is in operation in areas where navigation demands special caution

The decisions to be made in this context affect arrangement of navigational systems and equipment and procedures, and should be taken with the aim as specified in .1 of SOLAS regulation V/15.

- ❖ Main decisions in the context of **SOLAS regulation V/27** are related to provision and implementation of updates to nautical charts and publications, and include determination of:

- provision of system for appropriate updating
- routines safeguarding that nautical charts and publications to be used for the intended voyage are adequate and up-to-date

The decisions to be made in this context affect arrangement of navigational systems and equipment and procedures, and should be taken with the aim as specified in .1 of SOLAS regulation V/15.

- ❖ Main decision in the context of *SOLAS regulation V/28* is related to the availability of the record of navigational activities and incidents of sufficient detail to restore a complete record of the voyage. The decision includes determination of:
 - means to be provided for the recording
 - location of the means
 - routines for recording and storage

The decisions to be made in this context affect arrangement of navigational systems and equipment and procedures, and should be taken with the aim as specified in .1 of SOLAS regulation V/15.

The regulations addressed by SOLAS regulation V/15 need to be complied with prior to the ship being put in service and, consequently, also the applicable aims to be taken into account when applying the requirements of the regulations addressed.

In Appendix 1 attached to this Annex, the content of each aim is defined and clarified to reveal the full extent of the aims. This is for the purpose of giving further understanding of what compliance with the parts relevant for the particular regulation would entail within the framework of the UI.

3. FACTS AND PRINCIPLES GOVERNING DECISIONS AND SOLUTIONS

3.1 Bridge watch resources and design principles

The requirements set forth by the Recommendation addressing bridge design and location of equipment are based on SOLAS regulations V/19, Carriage requirements for shipborne navigational systems and equipment, and V/22, Navigation bridge visibility, taking into account applicable aims of SOLAS regulation V/15, the guidelines of MSC/Circ. 982 and relevant bridge watch resources. IMO manning principles and operational practice are the basis for design criteria and bridge team compositions.

3.1.1 Number of certified navigators on board – Bridge watch duty intervals

The ordinary legal complement of certified navigators in addition to the master on board cargo ships, ranges from two officers on smaller ships to three or four on seagoing ships. Examples of watch duty intervals are 6 or 4 hours twice in periods of 24 hours.

3.1.2 Manning of the bridge – Design criteria

Examples of bridge watch manning ranges from the officer in charge of the navigational watch during daytime supported by a rating assisting as “look-out” during darkness, to a complement also including assisting officer, the master, pilot and helmsman.

It is noted that the officer in charge of the navigational watch may be the only certified navigator attending the bridge watch during a sea voyage from pilot station to pilot station under normal operating conditions, assisted by the master governed by the level of professional experience of the officer in charge and routines for interval checks. (See the Recommendation, A 5.14.1 and Note to D 1.2).

Permanent bridge watch manning by two fully qualified officers is used on certain high speed vessels (SOLAS/30 knots) when navigating short regular routes and as required on ships in certain trades.

3.1.3 Manning of the bridge for safe navigation – Responsibility of the bridge management

Manning of the bridge for safe navigation under different operational conditions is the responsibility of the master and the officer in charge of the navigational watch.

It is a prerequisite that watchkeeping regulations and specifications of the STCW Convention and Code are complied with at all times, during daytime and darkness under all operational conditions, meaning that compliance with the requirements of the Recommendation does not justify relaxation of manning requirements or any other requirement within the IMO regulatory regime.

3.1.4 Bridge design criteria – Overall requirements

The overall design requirement is to enable efficient and safe performance by the officer in charge of the navigational watch as well as by two navigators in close co-operation, the pilot and any other identified member of the bridge team who may be allocated specific functions and tasks.

Furthermore, that the bridge layout, including location of workstations and outfitting, enables effective and safe bridge team management.

The composition of the bridge team, including permanent bridge watch manning by the officer of the watch (OOW) assisted by a rating or by a fully qualified officer, does not affect the responsibility of the OOW or the required field of vision and outfitting of the workstation, being based on safe performance of the tasks he is responsible for and prevention of human error.

3.2 User-oriented regulations

The content of the regulations to be applied is user-oriented, focusing on the need for bridge visibility and equipment to provide information and control necessary for the safe performance of navigation functions. Focus is also drawn on the need for establishing procedures to ensure instant availability of assistance to the bridge, technical efficiency of the steering gear, the use of adequate and up-to-date charts and recording of navigational activities.

This means that accepted solutions for application of the regulations need to be based on bridge functions and the tasks to be carried out based on the range of equipment and the fields of vision provided by the regulations, taking the relevant aims of SOLAS regulation V/15 into consideration, consulting MSC/Circ.982, developed for this purpose and referred to by SOLAS regulation V/15.

For further improving working conditions on the bridge, it has been regarded essential to include and organize requirements set forth in other IMO instruments related to performance of bridge functions. This includes the area of bridge alarm management. The chapter is valid until superseded by an IMO performance standard.

3.3 Bridge functions

Navigation functions, meaning the groups of tasks, duties and responsibilities necessary for safe bridge operation are basically the same for all ships. They are related to planning of the route prior to departure, keeping the ship on the course along the planned route from departure to destination, deviating from the route and adjusting speed for avoidance of collision and heavy weather damage while under way, and harbour manoeuvring.

Additional functions may include extended monitoring of machinery and domestic systems, tasks related to the carriage of different types of cargo and radio operations, or other relevant functions, all of which are regarded secondary to navigation functions if not carried out by a person additional to the officer of the watch.

3.3.1 Task performance

Performance of the tasks within the navigation functions may vary in accordance with operational conditions governed by the level of automation (integration) and the type of waters to be navigated, ranging from ocean areas to narrow waters with dense traffic and pilot waters. Change of speed and alteration of course and heading in relation to the route, waters, traffic and weather conditions are the essential decisions and actions related to navigation functions.

3.4 The workstation concept

A workstation should provide all basic information required and controls needed for safe performance of the function dedicated the workstation. The different workstations should be arranged and located for efficient co-operation by any number of a bridge team.

3.4.1 The workstation concept to be used on all SOLAS regulation V/15 bridges

The principles of the workstation concept are similar for all ships irrespective of ship types and sizes, operational conditions and methods of navigation. Should the special purpose of a ship cause a need to deviate from regular performance of navigation functions and bridge team management, the operational procedures need to be reviewed in relation to the bridge layout drawings. Ice-breaking, bow-mooring and dynamic positioning system may be some examples of special primary functions.

3.5 Responsibility of providing workplaces for safe and efficient operations

Appropriate functionality of bridge workplaces is governed by “User-oriented regulations” established by the flag states through IMO, addressing bridge design, arrangement of equipment, information needs and minimum range of equipment to be installed. The functionality and quality of navigational systems and equipment are governed by the content of IMO performance standards and the quality of IEC test standards used for verification of compliance. “Bridge functions”, “Task performance” and “The workstation concept” are main elements to be considered both by the regulators when establishing regulations as well as by the owners assisted by their professional users when specifying applicable solutions in co-operation with the builder.

These elements also need to be considered by surveyors on the basis of documentation at the stage of plan approval, while the functioning of systems after installation needs to be verified by tests and trials before the ship is put in service.

3.6 Competence, procedures and BRM - Responsibility of the management

The responsibility for selection and training of bridge personnel and maintenance of the technical standard of bridge systems lie with the owners and the master. It is regarded the responsibility of the master to provide appropriate watchkeeping procedures and check lists, taking into account national and international guidance. Allocation and use of bridge watch resources based on bridge resource management (BRM) principles in accordance with STCW Code (Section B-VIII/2) is the responsibility of the master and the officer in charge of the navigational watch. See chapter 4.

3.7 Use of type approved equipment - Responsibility of the user

It is the responsibility of the master and officers to navigate the ship safely under all operating conditions, utilizing all available means suitable for this purpose. However, when making decisions related to safety of navigation, it is unlawful to use information from equipment not type approved. If installed, it is considered the responsibility of the bridge team not to use such equipment for the purpose of navigation.

Type approved equipment may facilitate functions additional to the minimum required by the performance standards. This is accepted provided the display of information is not degraded and basic functions and equipment reliability are not affected. Compliance with these principles is to be considered during type approval.

A ship leaving port without being sufficiently equipped with type approved equipment (due to equipment failure) may be deemed not seaworthy by the port state control.

3.7.1 *Selection of system configurations and equipment for installation*

Consistency in the presentation of data and operation of individual equipment to be used for navigation (human/machine interface) is deemed essential to avoid misconception or misinterpretation of information and operational failures. Selection of equipment to be part of the configuration of systems integrated for the purpose of automation of navigation functions and the need for consistent and simple failure modes at system malfunction are deemed equally important.

However, the equipment and systems to be selected need to conform to IMO performance standards and appropriate test standards for equipment and integrated systems and be type approved. Choice of type approved equipment is considered the responsibility of the owner in consultancy with their professional users.

3.7.2 *The authority of IACS on behalf of flag state Administrations*

It is not regarded to be within the authority of this Recommendation to add equipment requirements to the content of current IMO standards. This would interfere with the IMO type approval regime and could deny acceptance of equipment and systems already type approved for their purpose and performance.

The authority of the IACS Recommendation in the context of selection of equipment is to ensure that the equipment and systems are appropriately type approved.

Type approved electronic chart display and information system (ECDIS) with back-up arrangement is a legal option to paper charts, provided appropriate charts (ENC) are available for the area of navigation. The functions of ECDIS, including the function of automatic real time positioning of the ship in the chart, are regarded to improve safety in bridge operations and meet the relevant aims of regulation V/15 to a greater extent than what can be achieved by the use of paper charts.

However, if not made mandatory by the flag state Administration, the choice of chart system is left to the owners and users who need to consider the usability of ECDIS in relation to the ship's type and trade and availability of ENC.

3.8 Responsibility of verification - Unified and predictable approval procedures

The responsibility for verifying compliance with applicable part of SOLAS Chapter V rests with the responsible organization (RO) when acting on behalf of the Administration, recognizing that owners, shipbuilders, equipment manufacturers and Administrations are in their right to expect similar consideration of technical solutions and documentation submitted.

3.9 Compliance at the time of delivery of the ship - Responsibility of the shipbuilder

It is regarded the responsibility of the shipbuilder to deliver the ship with valid certificates ascertaining that the ship is “seaworthy”. This includes verification of compliance with SOLAS regulations V/ 19 and 22, based on a specification agreed to by the owners and the shipyard taking into account the aims of regulation 15 and location of equipment for the purpose of simplifying procedures related to SOLAS regulations V/24, 25, 27 and 28.

4. CONCLUSIVE NOTE

In the context of safety of navigation and bridge operations, compliance with the aims of SOLAS regulation V/15 in accordance with the Recommendation prior to the ship being put in service, verifies that the bridge design and arrangement of navigational systems and equipment facilitate the tasks to be performed, allowing for expeditious, continuous and effective information processing and decision-making, minimizing unnecessary work, conditions or distractions that may cause fatigue or interfere with the vigilance of the bridge team and the pilot, thereby reducing the risk of human error.

By conforming to the workstation concept and bridge layout principles as required by the UI, the bridge design, layout and outfitting meet the aim of promoting effective and safe bridge resource management (BRM). The workstation and layout principles include provision of information and equipment in accordance with user requirements for performance of specific functions at dedicated workstations located for efficient and safe operations by the officer in charge of the navigational watch, the pilot and any composition of the bridge team under all operational conditions.

The use and allocation of bridge-watch resources, taking into consideration bridge resource management principles and operational concerns in accordance with the Guidance given by the STCW Code is the responsibility of the master and the officer in charge of the navigational watch.

More specifically, with reference to the STCW Code’s guidance on BRM, compliance with the relevant requirements of the Recommendation verifies that applicable decisions relating to regulation 15 have been taken with the aim of promoting effective and safe bridge resource management by:

- enabling individuals to be assigned at all times to locations at which they can most efficiently and effectively perform their duties;
- making instruments and equipment considered necessary for effective performance of duties readily available to appropriate members of the navigational watch;
- enabling effective co-operation and easy communication between members of the watch at their individual locations;
- safeguarding that non-essential activity and distractions are avoided within the navigational area of the bridge;

- enabling easy collection, processing and interpretation of essential information at individual locations which may conveniently be made available as required by other members of the watch for the performance of their duties.

In addition to utilizing the functionality and facilities provided by bridge design and arrangement of navigational systems and equipment in accordance with principles for effective and safe bridge resource management, it is the obligation of the master and the officer in charge of the navigational watch:

- to ascertain that the bridge team comprises a sufficient number of qualified individuals to ensure all duties can be performed effectively;
- to take into account any limitation in qualifications or fitness of the individuals available when making navigational and operational decisions;
- to assign duties clearly and unambiguously to specific individuals, who should confirm that they understand their responsibilities;
- not to assign more duties or more difficult tasks than can be performed effectively;
- to prevent fatigue in accordance with the guidance given in STCW Code, Section B-VIII/1.

4.1 Bridge team qualifications, training and operational procedures

The importance of a well trained, competent and motivated team for efficient and safe performance of bridge functions, supported by procedures tailored for maintaining the level of safety under different operational conditions, is not in doubt. This area, however, is related to the provisions and requirements of the STCW Convention, the STCW Code, various ILO Conventions as ratified by the flag state Administration, and the requirements of the International Safety Management Code (ISM).

Familiarization with duties, arrangements, equipment and systems, procedures and ship characteristics as required by the STCW Code as well as appropriate training and prevention of fatigue are regarded essential for efficient and safe bridge operation. Procedures for effective and safe bridge resource management (BRM), as well as for specific purposes specified in regulations 24, 25, 27 and 28 need to be established by the owner or operator and the master prior to the ship being put in service.

The Recommendation states basic points to be considered in this respect, relating to BRM, reduction of the risk of single person errors, concerns to be taken into account when introducing new technology (ECDIS) and provision of a familiarization scheme in compliance with the STCW Code. The procedures should become part of the ship's safety management plan which should be available on the bridge for ISM certification.

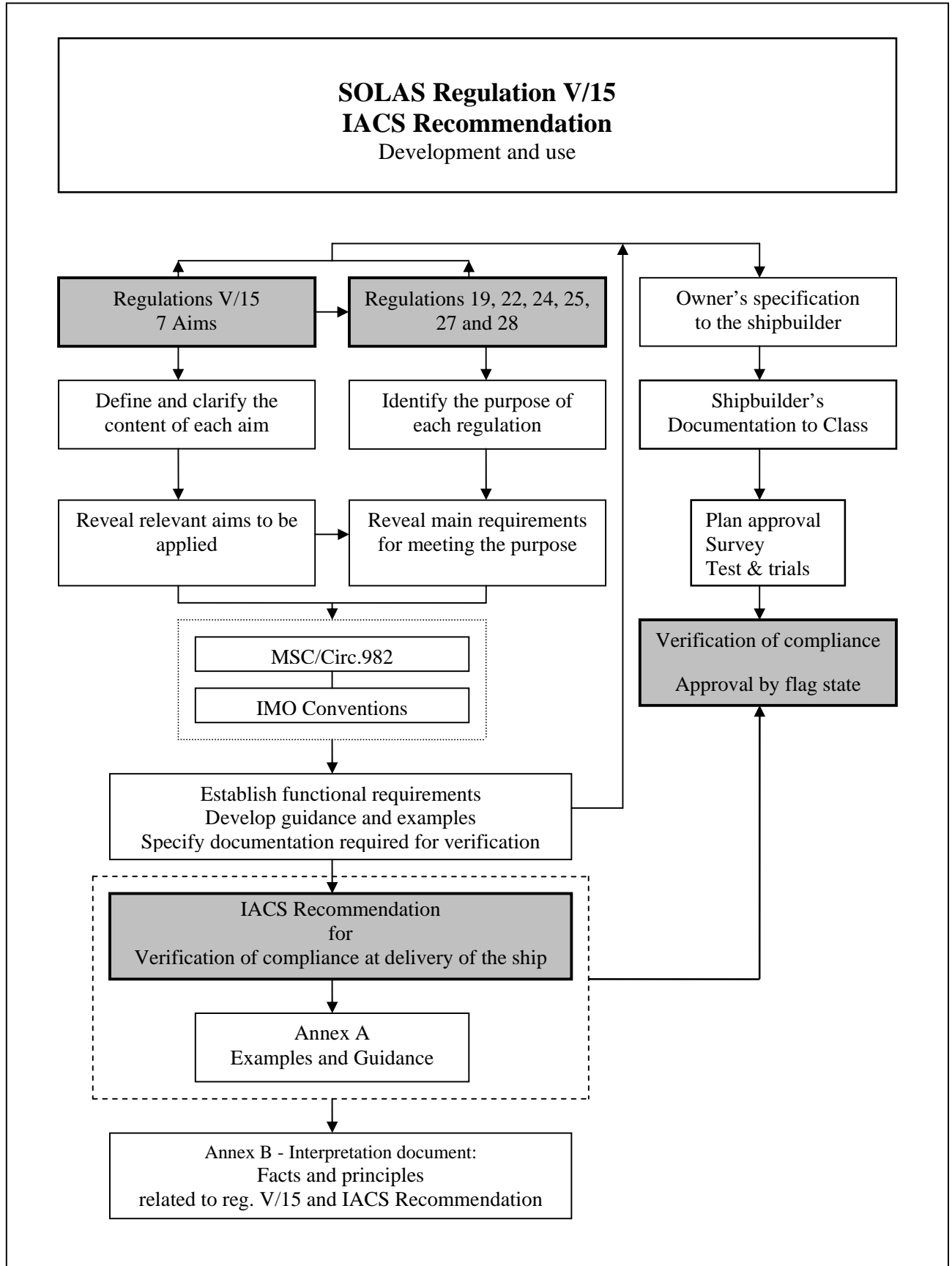

Appendix 1

of Annex B, IACS Recommendation 95

SOLAS Regulation V/15

Clarification of the content of each aim

The Aims of SOLAS Regulation V/15.....	15
Aim 15.1.....	15
Aim 15.2.....	17
Aim 15.3.....	17
Aim 15.4.....	18
Aim 15.5.....	19
Aim 15.6.....	20
Aim 15.7.....	20

The aims of SOLAS regulation V/15

In the following, the aims of regulation 15 are defined and clarified to establish a common understanding of the content of the individual aims, enabling a common approach in meeting the aims as specified in the regulation.

A view of the full extent of the aims is regarded essential for safeguarding that the aims are correctly applied within the areas of bridge design, the design and arrangement of navigational systems and equipment on the bridge and bridge procedures when applying the regulations addressed in regulation 15.

AIM 15.1

*Facilitating the **tasks¹** to be **performed by the bridge team and the pilot²** in making full appraisal of the situation and in navigating the ship safely under all **operational conditions³***

1 Overall functions to be performed

- Route planning
- Navigation
- Traffic surveillance
- Manoeuvring
- Docking
- Manual steering
- Conning
- Internal and external communication related to the tasks to be performed
- Pilotage

2 Basic functions and tasks performed by the bridge team (based on equipment carriage requirements and regular manning)

Officer in charge of the navigational watch:

- Navigation - Position-fixing by
 - o optical system
 - o radar system
 - o reading ship's position from display
 - o plotting ship's position
 - o visual observations
 - o monitoring - automatic pos.-fix. in electronic chart
- Route keeping
 - o Adjusting ship's heading to follow route
 - o Monitor automatic route-keeping
- Traffic surveillance
 - o Monitoring radar/ARPA
 - o Conning

- Collision avoidance
 - o Adjusting ship's heading and speed in relation to traffic
- Manoeuvring
- External and internal communication related to safety in bridge operations

Rating assisting the watch officer:

- Visual look-out

Navigator assisting the watch officer (or watch officer assisting the master):

- Navigation - Route monitoring
- Position-fixing
- Plotting ship's position
- Adjusting course
- Monitoring the waters

Rating relieving the automatic heading control:

- Manual steering

Pilot assisting in safe navigation:

- Conning and determination of heading and speed in relation to waters and traffic
- Position-fixing and traffic surveillance by available means
- Communication

3 Operational conditions and situations

Normal condition:

When all shipboard systems and equipment related to primary bridge functions operate within design limits and weather conditions or traffic do not cause excessive operator workloads.

Irregular condition:

When external conditions cause excessive operator workloads requiring qualified assistance on the bridge.

Abnormal condition:

When internal technical system failures require operation of basic back-up systems or when they occur during an irregular operating condition, or when the officer of the watch becomes unfit to perform his duties and has not yet been replaced by another qualified officer.

Emergency situation:

When failure of internal ship systems not affecting the ability of navigation or manoeuvring, or fire incidents occur which need to be controlled and managed from the bridge.

Distress situations:

When the ship has lost its navigating or manoeuvring ability.

3.1 Example of bridge team composition under different operational conditions

Reference which may be used for the purpose of design only:

Normal:	watch officer - Darkness: + rating
Irregular:	watch officer + assisting navigator (+ rating)
Abnormal:	master + watch officer + look-out (+ helmsman)
Emergency:	master + watch officer + assisting navigator + look-out (+ helmsman) (+ chief engineer/chief officer)

A pilot may be included in any of the above manning examples.

AIM 15.2

Promoting effective and safe bridge resource management¹

I Factors promoting safe resource management include:

- Organized distribution of tasks and responsibilities
- Functional workplace arrangement suiting different operational conditions, task distribution and task performance
- Instant availability of instruments and equipment necessary for efficient performance
- Qualifications and fitness of individuals
- Procedures for safe operations

AIM 15.3

*Enabling the bridge team and the pilot to have convenient and continuous access to **essential information¹** which is presented in a clear and unambiguous manner, **using standardized symbols and coding systems for controls and displays²***

I Essential information (and controls) required by the bridge team

The information and controls required, as well as what is to be regarded essential, are linked to the type and importance of tasks to be carried out by the individual members of the bridge team and the pilot.

The table showing Task and Means, which is included in chapter B 1 of the Recommendation identifies the essential information required. Easy access to information may be provided by outfitting and placing the workstations for efficient task performance by members of the bridge team in accordance with the content of chapter C 3.

2 Presentation of information and standardization

Requirements addressing presentation of information and coding of systems for controls and displays for equipment required to be carried are regulated by IMO performance standards and IEC test standards.

AIM 15.4

Indicating the operational status⁴ of automated functions¹ and integrated components², systems and/or sub-systems³

1 Relevant automated functions include:

- Steering a set course
- Plotting ship's position in an electronic chart system
- Steering along a planned route governed by ship's position
- Adjusting the speed according to ship's position and pre-set values
- Manoeuvring operations (Semi automatic/Joystick)

2 Relevant integrated type approved components may include:

- Heading control unit
- Satellite position-fixing unit (GNSS/GPS)
- Electronic chart display unit (ECDIS)
- Radar display unit
- Track control unit
- Speed control unit

3 Relevant systems include:

- Track control system
- Integrated navigation systems (INS), including
- Grounding avoidance system for automatic route-keeping

4 Indicating the operational status (of automated functions and integrated components, systems and/or sub-systems)

Indication of operational status is provided by:

- supplying continuous information of relevant system activities related to the ship's course, speed, propulsion, steering and operating mode on one individual display
- enabling continuous visual observation of key values
- enabling checking of the functioning of system elements and operational performance

- enabling early detection of deviations from planned operations and system specifications

Categories of indications that may be included:

Normal operation:

- Available components in the total system configuration
- Configuration in use
- Activity status of individual components in use
- Second mode of operation at system failure, preferably based on system failure mode, effect and criticality analysis (FMEAC)

Early warning:

- Reduced accuracy
- Reduced reliability of integrated system performance
- Reduced reliability of propulsion and steering system

Alarm conditions:

- Equipment malfunction
- System failure
- Display freeze

Operational warnings:

- Danger of collision
- Danger of grounding
- Weather conditions

AIM 15.5

Allowing for expeditious, continuous and effective information processing and decision-making¹ by the bridge team and the pilot²

1 Conditions allowing effective information processing and decision-making:

- When all information required for evaluation and decision-making is clearly presented and available at the location where action is to be taken on the decision made, including appropriate feedback on actions taken and updated information for continuous consideration.
- When information and equipment for performance of functions to be carried out by different members of the bridge team are available at specific workstations located for close co-operation.

2 See AIM 15.1, item 2

AIM 15.6

*Preventing or minimizing excessive or unnecessary work and any condition or distraction on the bridge which may cause fatigue or **interfere with the vigilance of the bridge team and the pilot***¹

I Conditions that may interfere with the vigilance of the bridge team include:

- Poor working environment caused by unsuitable colours, lighting, ventilation and temperature, including excessive noise and vibrations from machinery
- Poor bridge layout, allocating workstations and areas for non-navigational functions too close to the navigation area
- Insufficient provision of information for decision-making at the workstation, forcing the need to leave essential information or equipment at the workstation when in need of additional information or controls located elsewhere
- Lack of harmonization of workplace functionality
- Presence of unauthorized persons on the navigation bridge
- Heavy workloads

AIM 15.7

*Minimizing the risk of human error and detecting such error if it occurs*¹, *through monitoring and alarm systems*², *in time for the bridge team and the pilot to take appropriate action*³

I Factors minimizing human error include:

Workplace related:

- Functionality
- Information availability
- System reliability
- Human/machine interface
- Architecture of automation systems based on fail-to-safe philosophy with simple and reliable second mode of operations

Human related:

- Competence
- Attitude

Operational:

- Manning
- Working routines
- Allocation of task(s) in relation to competence

- Detection of inappropriate performance

2 Monitoring and alarm systems

Systems and methods enabling detection of human error and timely warning for appropriate action include:

- Monitoring and alarm transfer systems, monitoring personal activity and lack of response on operational warnings and alarm conditions related to safety of navigation and transfer of unacknowledged warnings and alarms to a qualified person

3 In time for appropriate action

Conditions affecting the time for appropriate action:

Operational warnings

- time to danger of collision and grounding (distance/speed)
- time to be allowed for required action