

Z10.4 Hull Surveys of Double Hull Oil Tankers

(Dec.
2001)
(Rev. 1
Oct. 2002)
(Rev.2
June
2005)
(Rev.3
Jan 2006)
(Rev.4
June 2006)
(Corr.1
Sept 2006)
(Rev.5
Feb 2007)
(Rev.6
Nov 2007)
(Rev.7
Mar 2009)
(Rev.8
Feb 2010)
(Rev.9
Mar 2011)
(Rev.10
July 2011)
(Rev.11
June 2013)
(Rev.12
Jan 2014)
(Rev.13
Feb 2015)

CONTENTS

- 1. General**
 - 1.1 Application
 - 1.2 Definitions
 - 1.3 Repairs
 - 1.4 Thickness Measurements And Close-Up Surveys
- 2. Special Survey**
 - 2.1 Schedule
 - 2.2 Scope
 - 2.3 Extent of Overall and Close-up Surveys
 - 2.4 Extent of Thickness Measurements
 - 2.5 Extent of Tank Testing
- 3. Annual Survey**
 - 3.1 Schedule
 - 3.2 Scope
- 4. Intermediate Survey**
 - 4.1 Schedule
 - 4.2 Scope
- 5. Preparation For Survey**
 - 5.1 Survey Programme
 - 5.2 Conditions For Survey
 - 5.3 Access To Structures
 - 5.4 Equipment For Survey
 - 5.5 Rescue and emergency response equipment
 - 5.6 Survey At Sea Or At Anchorage
 - 5.7 Survey Planning Meeting
- 6. Documentation On Board**
 - 6.1 General
 - 6.2 Survey Report File
 - 6.3 Supporting Documents
 - 6.4 Review Of Documentation On Board
- 7. Procedures For Thickness Measurement**
 - 7.1 General
 - 7.2 Certification Of Thickness Measurement Company
 - 7.3 Number and Locations of Measurements
 - 7.4 Reporting
- 8. Acceptance Criteria**
 - 8.1 General
 - 8.2 Acceptance criteria for pitting corrosion of CSR ships
 - 8.3 Acceptance criteria for edge corrosion of CSR ships
 - 8.4 Acceptance criteria for grooving corrosion of CSR ships

Z10.4
(cont'd)

- 9. Reporting and Evaluation of Survey**
- 9.1 Evaluation of Survey Report
- 9.2 Reporting

Z10.4

(cont'd)

ENCLOSURES

Table I:	Minimum requirements for Close-up Surveys at Special Survey of Double Hull Oil Tankers
Table II:	Minimum requirements for thickness measurements at Special Survey of Double Hull Oil Tankers
Table III:	Minimum requirements for tank testing at Special Survey of Double Hull Oil Tankers
Table IV:	Requirements for extent of thickness measurements at those areas of substantial corrosion
Table V:	Minimum requirements for overall and close-up survey and thickness measurements at intermediate survey of double hull oil tankers
Table VI:	Owners Inspection Report
Table VII:	Procedures for Certification of Firms Engaged in Thickness Gauging of Hull Structures
Table VIII:	Survey Reporting Principles
Table IX:	Executive Hull Summary
Annex I:	Guidelines for Technical Assessment in conjunction with planning for Enhanced Surveys of Double Hull Oil Tankers Special Survey - Hull
Annex II:	Recommended Procedures for Thickness Measurements of Double Hull Oil Tankers IACS Recommended Procedures for Thickness Measurements of Double Hull Oil Tankers Built Under IACS Common Structural Rules
Annex III:	Criteria for Longitudinal Strength of Hull Girder for Oil Tankers Appendix 1: Calculation criteria of section modulus of midship section of hull girder Appendix II: Diminution limit of minimum longitudinal strength of ships in service Appendix III: Sampling method of thickness measurements for longitudinal strength evaluation and repair methods
Annex IVA:	Survey Programme Appendix 1 List of Plans Appendix 2 Survey Planning Questionnaire Appendix 3 Other Documentation
Annex IVB:	Survey Planning Questionnaire
Annex IVC:	Owner's Inspection Report

Z10.4

(cont'd)

Note:

1. Changes introduced in Rev. 2 are to be uniformly implemented from 1 July 2006. The amendments to paragraphs 2.2.3.1 and 4.2.2.2 related to the protective coating condition are to apply to the ballast tanks of which the coating condition will be assessed at the forthcoming Special Survey and Intermediate Survey on or after 1 July 2006.
2. Changes introduced in Rev.3 (para. 1.4, 5.5.4, 5.5.6 and 7.1.3) are to be uniformly applied by IACS Societies on surveys commenced on or after 1 January 2007.
3. Changes introduced in Rev.4 are to be uniformly applied by IACS Societies on surveys commenced on or after 1 July 2007.
4. Changes introduced in Rev.5 are to be uniformly implemented for surveys commenced on or after 1 January 2008, whereas statutory requirements of IMO Res. MSC 197(80) apply on 1 January 2007.
5. Changes introduced in Rev.6 are to be uniformly applied by IACS Societies for surveys commenced on or after the 1 January 2009.
6. Changes introduced in Rev.7 are to be uniformly applied by IACS Societies for surveys commenced on or after 1 July 2010.

As for the requirements regarding semi-hard coatings, these coatings, if already applied, will not be accepted from the next special or intermediate survey commenced on or after 1 July 2010, whichever comes first, with respect to waiving the annual internal examination of the ballast tanks.

7. Changes introduced in Rev.9 are to be uniformly applied by IACS Societies for surveys commenced on or after 1 July 2012.
8. Changes introduced in Rev.10 are to be uniformly applied by IACS Societies for surveys commenced on or after 1 July 2012.
9. The changes to section 6 introduced in Rev.11 are to be uniformly applied by IACS Societies for surveys commenced on or after 1 July 2016. The other changes introduced in Rev.11 are to be uniformly applied by IACS Societies for surveys commenced on or after 1 July 2014.
10. Changes introduced in Rev.12 are to be uniformly applied by IACS Societies for surveys commenced on or after 1 January 2015.
11. Changes introduced in Rev.13 are to be uniformly applied by IACS Societies for surveys commenced on or after 1 July 2016.

Z10.4

(cont'd)

1. GENERAL**1.1 Application**

1.1.1

The requirements apply to all self-propelled Double Hull Oil Tankers.

1.1.2

The requirements apply to surveys of hull structure and piping systems in way of cargo tanks, pump rooms, cofferdams, pipe tunnels, void spaces within the cargo area and all ballast tanks. The requirements are additional to the classification requirements applicable to the remainder of the ship. Refer to Z7.

1.1.3

The requirements contain the minimum extent of examination, thickness measurements and tank testing. The survey is to be extended when Substantial Corrosion and/or structural defects are found and include additional Close-up Survey when necessary.

1.2 Definitions

1.2.1 Double Hull Oil Tanker

A Double Hull Oil Tanker is a ship which is constructed primarily for the carriage of oil¹⁾ in bulk, which have the cargo tanks protected by a double hull which extends for the entire length of the cargo area, consisting of double sides and double bottom spaces for the carriage of water ballast or void spaces.

1.2.2 Ballast Tank

A Ballast Tank is a tank which is used solely for the carriage of salt water ballast.

1.2.2 bis A Combined Cargo/Ballast Tank is a tank which is used for the carriage of cargo or ballast water as a routine part of the vessel's operation and will be treated as a Ballast Tank. Cargo tanks in which water ballast might be carried only in exceptional cases per MARPOL I/18(3) are to be treated as cargo tanks.

1.2.3 Overall Survey

An Overall Survey is a survey intended to report on the overall condition of the hull structure and determine the extent of additional Close-up Surveys.

1.2.4 Close-up Survey

A Close-up Survey is a survey where the details of structural components are within the close visual inspection range of the surveyor, i.e. normally within reach of hand.

Note: ¹⁾ MARPOL Annex I cargoes
The requirements in this UR are also applicable to existing double hull tankers not complying with MARPOL Regulation 13F, but having a U-shaped midship section.

Z10.4

(cont'd)

1.2.5 Transverse Section

A Transverse Section includes all longitudinal members such as plating, longitudinals and girders at the deck, sides, bottom, inner bottom and longitudinal bulkheads. For transversely framed vessels, a transverse section includes adjacent frames and their end connections in way of transverse sections.

1.2.6 Representative Tank

Representative Tanks are those which are expected to reflect the condition of other tanks of similar type and service and with similar corrosion prevention systems. When selecting Representative Tanks account is to be taken of the service and repair history onboard and identifiable Critical Structural Areas and/or Suspect Areas.

1.2.7 Suspect Area

Suspect Areas are locations showing Substantial Corrosion and/or are considered by the Surveyor to be prone to rapid wastage.

1.2.8 Critical Structural Area

Critical Structural Areas are locations which have been identified from calculations to require monitoring or from the service history of the subject ship or from similar or sister ships (if available) to be sensitive to cracking, buckling or corrosion which would impair the structural integrity of the ship.

1.2.9 Renewal Thickness

Renewal thickness (t_{ren}) is the minimum allowable thickness, in mm, below which renewal of structural members is to be carried out.

1.2.10 Substantial Corrosion

Substantial Corrosion is an extent of corrosion such that assessment of corrosion pattern indicates a wastage in excess of 75% of allowable margins, but within acceptable limits. For vessels built under the IACS Common Structural Rules, substantial corrosion is an extent of corrosion such that the assessment of the corrosion pattern indicates a measured thickness between $t_{ren} + 0.5\text{mm}$ and t_{ren} .

1.2.11 Corrosion Prevention System

A Corrosion Prevention System is normally considered a full hard protective coating.

Hard Protective Coating is usually to be epoxy coating or equivalent. Other coating systems, which are neither soft nor semi-hard coatings, may be considered acceptable as alternatives provided that they are applied and maintained in compliance with the manufacturer's specifications.

1.2.12 Coating Condition

Coating condition is defined as follows:

- **GOOD** condition with only minor spot rusting,
- **FAIR** condition with local breakdown at edges of stiffeners and weld connections and/or light rusting over 20% or more of areas under

Z10.4

(cont'd)

- **POOR** consideration, but less than as defined for POOR condition, condition with general breakdown of coating over 20% or more, or hard scale at 10% or more, of areas under consideration.

Reference is made to IACS Recommendation No.87 "Guidelines for Coating Maintenance & Repairs for Ballast Tanks and Combined Cargo / Ballast Tanks on Oil Tankers"

1.2.13 Cargo Area

Cargo Area is that part of the ship which contains cargo tanks, slop tanks and cargo/ballast pump-rooms, cofferdams, ballast tanks and void spaces adjacent to cargo tanks and also deck areas throughout the entire length and breadth of the part of the ship over the above mentioned spaces.

1.2.14 Special consideration

Special consideration or specially considered (in connection with close-up surveys and thickness measurements) means sufficient close-up inspection and thickness measurements are to be taken to confirm the actual average condition of the structure under the coating.

1.2.15 Prompt and Thorough Repair

A Prompt and Thorough Repair is a permanent repair completed at the time of survey to the satisfaction of the Surveyor, therein removing the need for the imposition of any associated condition of classification, or recommendation.

1.2.16 Pitting Corrosion

Pitting corrosion is defined as scattered corrosion spots/areas with local material reductions which are greater than the general corrosion in the surrounding area. Pitting intensity is defined in Figure 1.

1.2.17 Edge Corrosion

Edge corrosion is defined as local corrosion at the free edges of plates, stiffeners, primary support members and around openings. An example of edge corrosion is shown in Figure 2.

1.2.18 Grooving Corrosion

Grooving corrosion is typically local material loss adjacent to weld joints along abutting stiffeners and at stiffener or plate butts or seams. An example of groove corrosion is shown in Figure 3.

Z10.4
(cont'd)

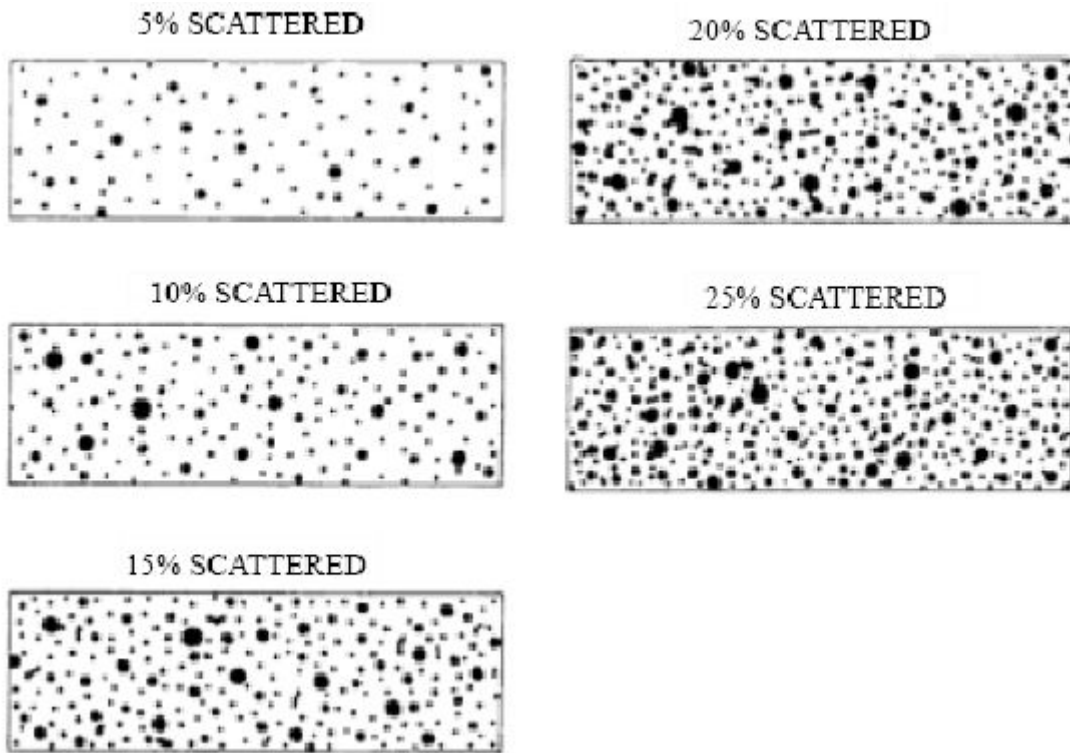

Figure 1 - Pitting intensity diagrams

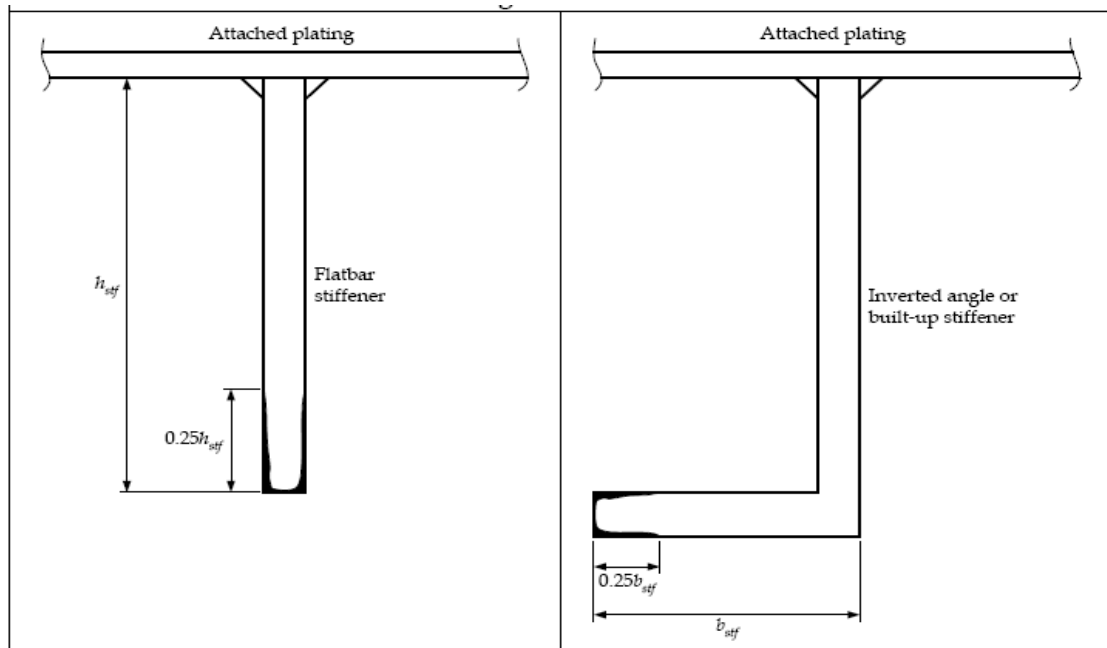

Figure 2 - Edge corrosion

Z10.4

(cont'd)

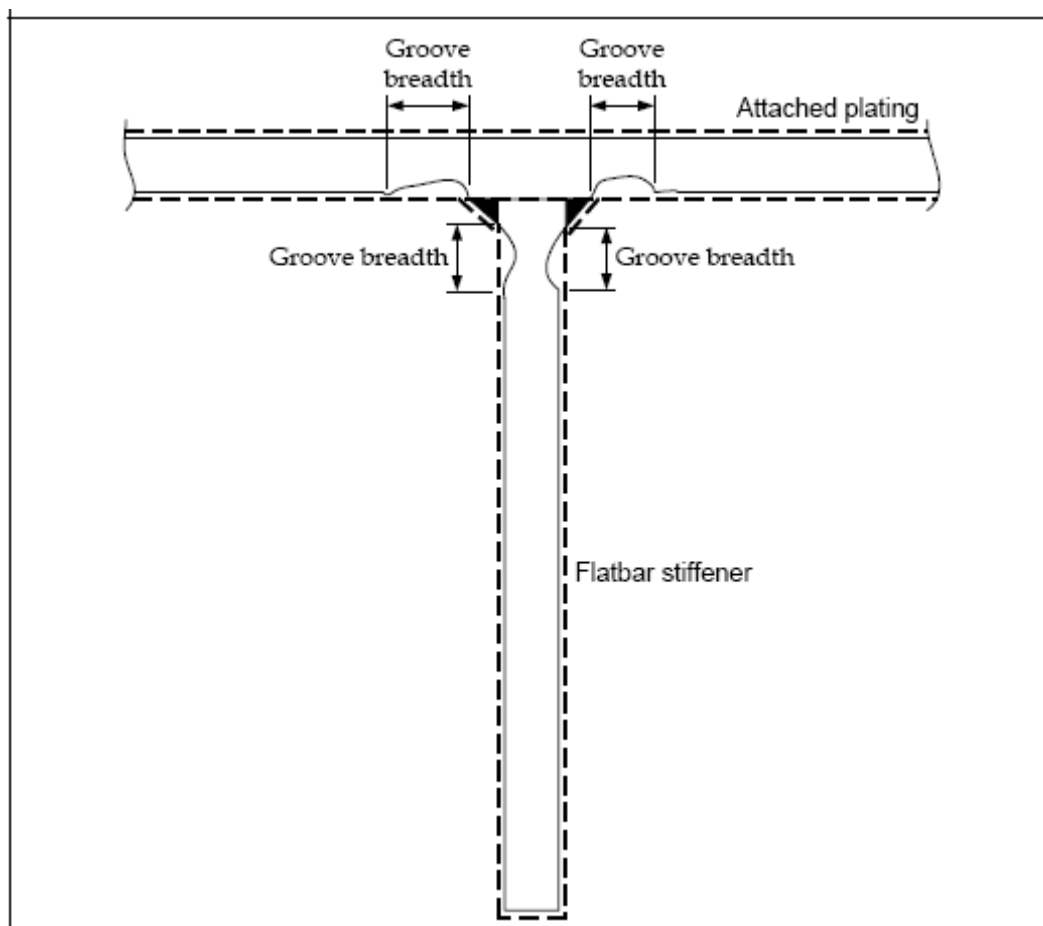

Figure 3 - Grooving corrosion

1.3 Repairs

1.3.1

Any damage in association with wastage over the allowable limits (including buckling, grooving, detachment or fracture), or extensive areas of wastage over the allowable limits, which affects or, in the opinion of the Surveyor, will affect the vessel's structural, watertight or weathertight integrity, is to be promptly and thoroughly (see 1.2.14) repaired. Areas to be considered include:

- bottom structure and bottom plating;
- side structure and side plating;
- deck structure and deck plating;
- watertight or oiltight bulkheads,
- hatch covers or hatch coamings, where fitted (combination carriers).

For locations where adequate repair facilities are not available, consideration may be given to allow the vessel to proceed directly to a repair facility. This may require discharging the cargo and/or temporary repairs for the intended voyage.

Z10.4

(cont'd)

1.3.2

Additionally, when a survey results in the identification of structural defects or corrosion, either of which, in the opinion of the Surveyor, will impair the vessel's fitness for continued service, remedial measures are to be implemented before the ship continues in service.

1.3.3

Where the damage found on structure mentioned in Para. 1.3.1 is isolated and of a localised nature which does not affect the ship's structural integrity, consideration may be given by the surveyor to allow an appropriate temporary repair to restore watertight or weather tight integrity and impose a Recommendation/Condition of Class in accordance with IACS PR 35, with a specific time limit.

1.4 Thickness measurements and close-up surveys

In any kind of survey, i.e. special, intermediate, annual or other surveys having the scope of the foregoing ones, thickness measurements, when required by Table II, of structures in areas where close-up surveys are required shall be carried out simultaneously with close-up surveys.

Z10.4

(cont'd)

2. SPECIAL SURVEY⁽²⁾**2.1 Schedule**

2.1.1

Special Surveys are to be carried out at 5 years intervals to renew the Classification Certificate.

2.1.2

The first Special Survey is to be completed within 5 years from the date of the initial classification survey and thereafter within 5 years from the credited date of the previous Special Survey. However, an extension of class of 3 months maximum beyond the 5th year can be granted in exceptional circumstances.

In this case, the next period of class will start from the expiry date of the Special Survey before the extension was granted.

2.1.3

For surveys completed within 3 months before the expiry date of the Special Survey, the next period of class will start from the expiry date of the Special Survey. For surveys completed more than 3 months before the expiry date of the Special Survey, the period of class will start from the survey completion date.

In cases where the vessel has been laid up or has been out of service for a considerable period because of a major repair or modification and the owner elects to only carry out the overdue surveys, the next period of class will start from the expiry date of the special survey. If the owner elects to carry out the next due special survey, the period of class will start from the survey completion date.

2.1.4

The Special Survey may be commenced at the 4th Annual Survey and be progressed with a view to completion by the 5th anniversary date. When the Special Survey is commenced prior to the 4th Annual Survey, the entire survey is to be completed within 15 months if such work is to be credited to the Special Survey.

2.1.5

Concurrent crediting to both Intermediate Survey (IS) and Special Survey (SS) for surveys and thickness measurements of spaces are not acceptable.

Note: ²⁾ Some member Societies use the term "Special Periodical Survey" others use the term "Class Renewal Survey" instead of the term "Special Survey".

Z10.4

(cont'd)

2.2 Scope**2.2.1 General****2.2.1.1**

The Special Survey is to include, in addition to the requirements of the Annual Survey, examination, tests and checks of sufficient extent to ensure that the hull and related piping, as required in 2.2.1.3, is in a satisfactory condition and is fit for its intended purpose for the new period of class of 5 years to be assigned, subject to proper maintenance and operation and to periodical surveys being carried out at the due dates.

2.2.1.2

All cargo tanks, Ballast Tanks, including double bottom tanks, pump rooms, pipe tunnels, cofferdams and void spaces bounding cargo tanks, decks and outer hull are to be examined, and this examination is to be supplemented by thickness measurement and testing as required in 2.4 and 2.5, to ensure that the structural integrity remains effective. The aim of the examination is to discover Substantial Corrosion, significant deformation, fractures, damages or other structural deterioration that may be present.

2.2.1.3

Cargo piping on deck, including Crude Oil Washing (COW) piping, Cargo and Ballast piping within the above tanks and spaces are to be examined and operationally tested to working pressure to attending Surveyor's satisfaction to ensure that tightness and condition remain satisfactory. Special attention is to be given to any ballast piping in cargo tanks and any cargo piping in ballast tanks and void spaces, and Surveyors are to be advised on all occasions when this piping, including valves and fittings are open during repair periods and can be examined internally.

2.2.2 Dry Dock Survey**2.2.2.1**

A survey in dry dock is to be a part of the Special Survey. The overall and close-up surveys and thickness measurements, as applicable, of the lower portions of the cargo tanks and ballast tanks are to be carried out in accordance with the applicable requirements for special surveys, if not already performed.

Note: Lower portions of the cargo and ballast tanks are considered to be the parts below light ballast water line.

2.2.3 Tank Protection**2.2.3.1**

Where provided, the condition of the corrosion prevention system of cargo tanks is to be examined.

A Ballast Tank is to be examined at subsequent annual intervals where:

- a. a **hard** protective coating has not been applied from the time of construction, or
- b. a soft or semi-hard coating has been applied, or
- c. substantial corrosion is found within the tank, or
- d. the **hard** protective coating is found to be in less than GOOD condition and the **hard** protective coating is not repaired to the satisfaction of the Surveyor.

Z10.4

(cont'd)

Thickness measurements are to be carried out as deemed necessary by the surveyor.

2.3 Extent of Overall and Close-up Surveys

2.3.1

An Overall Survey of all tanks and spaces is to be carried out at each Special Survey.

2.3.2

The minimum requirements for Close-up Surveys at Special Survey are given in Table I.

2.3.3

The Surveyor may extend the Close-up Survey as deemed necessary taking into account the maintenance of the tanks under survey, the condition of the corrosion prevention system and also in the following cases:

- a) in particular, tanks having structural arrangements or details which have suffered defects in similar tanks or on similar ships according to available information,
- b) In tanks which have structures approved with reduced scantlings due to an approved corrosion control system.

2.3.4

For areas in tanks where hard protective coatings are found to be in a GOOD condition as defined in 1.2.11, the extent of Close-up Surveys according to Table I may be specially considered.

2.4 Extent of Thickness Measurements

2.4.1

The minimum requirements for thickness measurements at Special Survey are given in Table II.

2.4.2

Provisions for extended measurements for areas with Substantial Corrosion are given in Table IV, and as may be additionally specified in the Survey Programme as required in 5.1. These extended thickness measurements are to be carried out before the survey is credited as completed. Suspect Areas identified at previous surveys are to be examined. Areas of substantial corrosion identified at previous surveys are to have thickness measurements taken.

For vessels built under IACS Common Structural Rules, the identified substantial corrosion areas are required to be examined and additional thickness measurements are to be carried out at annual and intermediate surveys.

2.4.3

The Surveyor may further extend the thickness measurements as deemed necessary.

2.4.4

For areas in tanks where hard protective coating are found to be in a GOOD condition as defined in 1.2.11, the extent of thickness measurements according to Table II may be specially considered.

2.4.5

Transverse sections are to be chosen where the largest reductions are suspected to occur or are revealed from deck plating measurements.

Z10.4 (cont'd)

2.4.6

In cases where two or three sections are to be measured, at least one is to include a Ballast Tank within 0.5L amidships.

In case of oil tankers of 130m in length and upwards (as defined in the International Convention on Load Lines in force) and more than 10 years of age, for the evaluation of the ship's longitudinal strength as required in ~~8.4.4.4~~ 9.1.1.1, the sampling method of thickness measurements is given in Annex III Appendix 3.

2.5 Extent of Tank Testing

2.5.1

The minimum requirements for ballast tank testing at Special Survey are given in 2.5.3 and Table III.

The minimum requirements for cargo tank testing at Special Survey are given in 2.5.4 and Table III.

Cargo tank testing carried out by the vessel's crew under the direction of the Master may be accepted by the surveyor provided the following conditions are complied with:

- a) a tank testing procedure, specifying fill heights, tanks being filled and bulkheads being tested, has been submitted by the owner and reviewed by the Society prior to the testing being carried out;
- b) there is no record of leakage, distortion or substantial corrosion that would affect the structural integrity of the tank;
- c) the tank testing has been satisfactorily carried out within special survey window not more than 3 months prior to the date of the survey on which the overall or close up survey is completed;
- d) the satisfactory results of the testing is recorded in the vessel's logbook;
- e) the internal and external condition of the tanks and associated structure are found satisfactory by the surveyor at the time of the overall and close up survey.

2.5.2

The Surveyor may extend the tank testing as deemed necessary.

2.5.3

Boundaries of ballast tanks are to be tested with a head of liquid to the top of air pipes.

2.5.4

Boundaries of cargo tanks are to be tested to the highest point that liquid will rise under service conditions.

2.5.5

The testing of double bottom tanks and other spaces not designed for the carriage of liquid may be omitted, provided a satisfactory internal examination together with an examination of the tanktop is carried out.

Z10.4

(cont'd)

3. ANNUAL SURVEY**3.1 Schedule**

3.1.1

Annual Surveys are to be held within 3 months before or after anniversary date from the date of the initial classification survey or of the date credited for the last Special Survey.

3.2 Scope

3.2.1 General

3.2.1.1

The survey is to consist of an examination for the purpose of ensuring, as far as practicable, that the hull and piping are maintained in a satisfactory condition.

3.2.2 Examination of the hull

3.2.2.1

Examination of the hull plating and its closing appliances as far as can be seen.

3.2.2.2

Examination of watertight penetrations as far as practicable.

3.2.3 Examination of the weather deck

3.2.3.1

Examination of cargo tank openings including gaskets, covers, coamings and flame screens.

3.2.3.2

Examination of cargo tanks pressure/vacuum valves and flame screens.

3.2.3.3

Examination of flame screens on vents to all bunker tanks.

3.2.3.4

Examination of cargo, crude oil washing, bunker and vent piping systems, including vent masts and headers.

3.2.4 Examination of cargo pump rooms and pipe tunnels if fitted.

3.2.4.1

Examination of all pump room bulkheads for signs of oil leakage or fractures and, in particular, the sealing arrangements of all penetrations of pump room bulkheads.

3.2.4.2

Examination of the condition of all piping systems.

3.2.5 Examination of Ballast Tanks

3.2.5.1

Examination of Ballast Tanks where required as a consequence of the results of the Special Survey (see 2.2.3) and Intermediate Survey (see 4.2.2.1 and 4.2.2.2) is to be carried out. When considered necessary by the Surveyor, or when extensive corrosion exists, thickness

Z10.4
(cont'd)

measurements are to be carried out and if the results of these thickness measurements indicate that Substantial Corrosion is found, the extent of thickness measurements is to be increased in accordance with Table IV. These extended thickness measurements are to be carried out before the survey is credited as completed. Suspect Areas identified at previous surveys are to be examined. Areas of substantial corrosion identified at previous surveys are to have thickness measurements taken.

For vessels built under IACS Common Structural Rules, the identified substantial corrosion areas are required to be examined and additional thickness measurements are to be carried out.

Z10.4
(cont'd)**4. INTERMEDIATE SURVEY****4.1 Schedule**

4.1.1

The Intermediate Survey is to be held at or between either the 2nd or 3rd Annual Survey.

4.1.2

Those items, which are additional to the requirements of the Annual Surveys, may be surveyed either at or between the 2nd and 3rd Annual Survey.

4.1.3

Concurrent crediting to both Intermediate Survey (IS) and Special Survey (SS) for surveys and thickness measurements of spaces are not acceptable.

4.2 Scope

4.2.1 General

4.2.1.1

The survey extent is dependent on the age of the vessel as specified in 4.2.2 to 4.2.4 and shown in Table V.

4.2.1.2

For weather decks, an examination as far as applicable of cargo, crude oil washing, bunker, ballast, steam and vent piping systems as well as vent masts and headers is to be carried out. If upon examination there is any doubt as to the condition of the piping, the piping may be required to be pressure-tested, thickness measured or both.

4.2.1.3

For vessels built under IACS Common Structural Rules, the identified substantial corrosion areas are required to be examined and additional thickness measurements are to be carried out.

4.2.2 Double Hull Oil Tankers between 5 and 10 years of age. The following is to apply:

4.2.2.1

For tanks used for salt-water ballast, an Overall Survey of Representative Tanks selected by the Surveyor is to be carried out.

If such inspections reveal no visible structural defects, the examination may be limited to a verification that the hard protective coating remains in GOOD condition.

4.2.2.2

A Ballast Tank is to be examined at subsequent annual intervals where:

- a. a hard protective coating has not been applied from the time of construction, or
- b. a soft or semi-hard coating has been applied, or
- c. substantial corrosion is found within the tank, or
- d. the hard protective coating is found to be in less than GOOD condition and the hard protective coating is not repaired to the satisfaction of the Surveyor.

Z10.4
(cont'd)

4.2.2.3

In addition to the requirements above, suspect areas identified at previous surveys are to be examined.

4.2.3 Double Hull Oil Tankers between 10 and 15 years of age. The following is to apply:

4.2.3.1

The requirements of the Intermediate Survey are to be to the same extent as the previous Special Survey as required in 2 and 5.1. However, pressure testing of cargo and ballast tanks *and the requirements for longitudinal strength evaluation of Hull Girder as required in 8.1.1.1* are not required unless deemed necessary by the attending Surveyor.

4.2.3.2

In application of 4.2.3.1, the intermediate survey may be commenced at the second annual survey and be progressed during the succeeding year with a view to completion at the third annual survey in lieu of the application of 2.1.4.

4.2.3.3

In application of 4.2.3.1, an under water survey may be considered in lieu of the requirements of 2.2.2.

4.2.4 Double Hull Oil Tankers over 15 years of age. The following is to apply:

4.2.4.1

The requirements of the Intermediate Survey are to be to the same extent as the previous Special Survey as required in 2 and 5.1. However, pressure testing of cargo and ballast tanks *and the requirements for longitudinal strength evaluation of Hull Girder as required in 8.1.1.1* are not required unless deemed necessary by the attending Surveyor.

4.2.4.2

In application of 4.2.4.1, the intermediate survey may be commenced at the second annual survey and be progressed during the succeeding year with a view to completion at the third annual survey in lieu of the application of 2.1.4.

4.2.4.3

In application of 4.2.4.1, a survey in dry dock is to be part of the intermediate survey. The overall and close-up surveys and thickness measurements, as applicable, of the lower portions of the cargo tanks and water ballast tanks are to be carried out in accordance with the applicable requirements for intermediate surveys, if not already carried out.

Note: Lower portions of the cargo and ballast tanks are considered to be the parts below light ballast water line.

Z10.4

(cont'd)

5. PREPARATION FOR SURVEY**5.1 Survey Programme**

5.1.1

The Owner in co-operation with the Classification Society is to work out a specific Survey Programme prior to the commencement of any part of:

- the Special Survey
- the Intermediate Survey for oil tanker over 10 years of age

The Survey Programme at Intermediate Survey may consist of the Survey Programme at the previous Special Survey supplemented by the Executive Hull Summary of that Special Survey and later relevant survey reports.

The Survey Programme is to be worked out taking into account any amendments to the survey requirements implemented after the last Special Survey carried out.

The Survey Programme is to be in a written format based on the information in annex IVA. The survey is not to commence until the survey programme has been agreed.

5.1.1.1 Prior to the development of the survey programme, the survey planning questionnaire is to be completed by the owner based on the information set out in annex IVB, and forwarded to the Classification Society.

5.1.2

In developing the survey programme, the following documentation is to be collected and consulted with a view to selecting tanks, areas, and structural elements to be examined:

- .1 survey status and basic ship information;
- .2 documentation on board, as described in 6.2 and 6.3;
- .3 main structural plans of cargo and ballast tanks (scantlings drawings), including information regarding use of high-tensile steels (HTS);
- .4 Executive Hull Summary;
- .5 relevant previous damage and repair history;
- .6 relevant previous survey and inspection reports from both the recognized organization and the owner;
- .7 cargo and ballast history for the last 3 years, including carriage of cargo under heated conditions;
- .8 details of the inert gas plant and tank cleaning procedures;
- .9 information and other relevant data regarding conversion or modification of the ship's cargo and ballast tanks since the time of construction;

Z10.4

(cont'd)

- .10 description and history of the coating and corrosion protection system (previous class notations), if any;
- .11 inspections by the Owner's personnel during the last 3 years with reference to structural deterioration in general, leakages in tank boundaries and piping and condition of the coating and corrosion protection system if any.
- .12 information regarding the relevant maintenance level during operation including port state control reports of inspection containing hull related deficiencies, Safety Management System non-conformities relating to hull maintenance, including the associated corrective action(s); and
- .13 any other information that will help identify suspect areas and critical structural areas

5.1.3

The submitted Survey Programme is to account for and comply, as a minimum, with the requirements of Tables I, II and 2.5 for close-up survey, thickness measurement and tank testing, respectively, and is to include relevant information including at least:

- .1 basic ship information and particulars;
- .2 main structural plans (scantling drawings), including information regarding use of high tensile steels (HTS);
- .3 plan of tanks;
- .4 list of tanks with information on use, corrosion prevention and condition of coating;
- .5 conditions for survey (e.g., information regarding tank cleaning, gas freeing, ventilation, lighting, etc.);
- .6 provisions and methods for access to structures;
- .7 equipment for surveys;
- .8 nomination of tanks and areas for close-up survey (per 2.3);
- .9 nominations of sections for thickness measurement (per 2.4);
- .10 nomination of tanks for tank testing (per 2.5);
- .11 identification of the thickness measurement company;
- .12 damage experience related to the ship in question;
- .13 critical structural areas and suspect areas, where relevant.

Z10.4

(cont'd)

5.1.4

The Classification Society will advise the Owner of the maximum acceptable structural corrosion diminution levels applicable to the vessel.

5.1.5

Use may also be made of the Guidelines for Technical Assessment in Conjunction with Planning for Enhanced Surveys of Double Hull Oil Tankers Special Survey - Hull, contained in Annex I. These guidelines are a recommended tool which may be invoked at the discretion of the Classification Society, when considered necessary and appropriate, in conjunction with the preparation of the required Survey Programme.

5.2 Conditions for survey

5.2.1

The Owner is to provide the necessary facilities for a safe execution of the survey.

5.2.1.1 In order to enable the attending surveyors to carry out the survey, provisions for proper and safe access are to be agreed between the owner and the Classification society are to be in accordance with IACS PR 37.

5.2.1.2 Details of the means of access are to be provided in the survey planning questionnaire.

5.2.1.3 In cases where the provisions of safety and required access are judged by the attending surveyors not to be adequate, the survey of the spaces involved is to not proceed.

5.2.2

Tanks and spaces are to be safe for access. Tanks and spaces are to be gas free and properly ventilated. Prior to entering a tank, void or enclosed space, it is to be verified that the atmosphere in that space is free from hazardous gas and contains sufficient oxygen.

5.2.3

In preparation for survey and thickness measurements and to allow for a thorough examination, all spaces are to be cleaned including removal from surfaces of all loose accumulated corrosion scale. Spaces are to be sufficiently clean and free from water, scale, dirt, oil residues etc. to reveal corrosion, deformation, fractures, damages, or other structural deterioration as well as the condition of the coating. However, those areas of structure whose renewal has already been decided by the owner need only be cleaned and descaled to the extent necessary to determine the limits of the areas to be renewed.

5.2.4

Sufficient illumination is to be provided to reveal corrosion, deformation, fractures, damages or other structural deterioration.

5.2.5

Where Soft or Semi-hard Coatings have been applied, safe access is to be provided for the surveyor to verify the effectiveness of the coating and to carry out an assessment of the

Z10.4

(cont'd)

conditions of internal structures which may include spot removal of the coating. When safe access cannot be provided, the soft or semi-hard coating is to be removed.

5.3 Access to structures

5.3.1

For overall survey, means are to be provided to enable the surveyor to examine the hull structure in a safe and practical way.

5.3.2

For close-up survey, one or more of the following means for access, acceptable to the Surveyor, is to be provided:

- permanent staging and passages through structures;
- temporary staging and passages through structures;
- hydraulic arm vehicles such as conventional cherry pickers, lifts and movable platforms;
- boats or rafts;
- portable ladders;
- other equivalent means.

5.4 Equipment for survey

5.4.1

Thickness measurement is normally to be carried out by means of ultrasonic test equipment. The accuracy of the equipment is to be proven to the Surveyor as required.

5.4.2

One or more of the following fracture detection procedures may be required if deemed necessary by the Surveyor:

- radiographic equipment;
- ultrasonic equipment;
- magnetic particle equipment;
- dye penetrant.

5.4.3

Explosimeter, oxygen-meter, breathing apparatus, lifelines, riding belts with rope and hook and whistles together with instructions and guidance on their use are to be made available during the survey. A safety check-list is to be provided.

5.4.4

Adequate and safe lighting is to be provided for the safe and efficient conduct of the survey.

5.4.5

Adequate protective clothing is to be made available and used during the survey (e.g. safety helmet, gloves, safety shoes, etc.).

Z10.4

(cont'd)

5.5 Rescue and emergency response equipment

If breathing apparatus and/or other equipment is used as 'Rescue and emergency response equipment' then it is recommended that the equipment should be suitable for the configuration of the space being surveyed.

5.6 Survey at sea or at anchorage

5.6.1

Survey at sea or at anchorage may be accepted provided the Surveyor is given the necessary assistance from the personnel onboard. Necessary precautions and procedures for carrying out the survey are to be in accordance with 5.1, 5.2, 5.3 and 5.4.

5.6.2

A communication system is to be arranged between the survey party in the tank and the responsible officer on deck. This system is to include the personnel in charge of ballast pump handling if boats or rafts are used.

5.6.3

Surveys of tanks by means of boats or rafts may only be undertaken with the agreement of the Surveyor, who is to take into account the safety arrangements provided, including weather forecasting and ship response under foreseeable conditions and provided the expected rise of water within the tank does not exceed 0.25m.

5.6.4

When rafts or boats are used for close-up surveys, the following conditions are to be observed:

- .1 only rough duty, inflatable rafts or boats, having satisfactory residual buoyancy and stability even if one chamber is ruptured, are to be used;
- .2 the boat or raft is to be tethered to the access ladder and an additional person is to be stationed down the access ladder with a clear view of the boat or raft;
- .3 appropriate lifejackets are to be available for all participants;
- .4 the surface of water in the tank is to be calm (under all foreseeable conditions the expected rise of water within the tank is to not exceed 0.25 m) and the water level stationary. On no account is the level of the water to be rising while the boat or raft is in use;
- .5 the tank or space must contain clean ballast water only. Even a thin sheen of oil on the water is not acceptable;
- .6 at no time should the water level be allowed to be within 1 m of the deepest under deck web face flat so that the survey team is not isolated from a direct escape route to the tank hatch. Filling to levels above the deck transverses should only be contemplated if a deck access manhole is fitted and open in the bay being examined, so that an escape route for the survey party is available at all times. Other effective means of escape to the deck may be considered;
- .7 if the tanks (or spaces) are connected by a common venting system, or inert gas system, the tank in which the boat or raft should be used should be isolated to prevent a transfer of gas from other tanks (or spaces).

Z10.4 (cont'd)

5.6.5

Rafts or boats alone may be allowed for inspection of the under deck areas for tanks or spaces, if the depth of the webs is 1.5 m or less.

5.6.6

If the depth of the webs is more than 1.5 m, rafts or boats alone may be allowed only:

- .1 when the coating of the under deck structure is in GOOD condition and there is no evidence of wastage; or
- .2 if a permanent means of access is provided in each bay to allow safe entry and exit. This means:
 - i. access direct from the deck via a vertical ladder and a small platform fitted approximately 2 m below the deck in each bay; or
 - ii. access to deck from a longitudinal permanent platform having ladders to deck in each end of the tank. The platform shall, for the full length of the tank, be arranged in level with, or above, the maximum water level needed for rafting of under deck structure. For this purpose, the ullage corresponding to the maximum water level is to be assumed not more than 3m from the deck plate measured at the midspan of deck transverses and in the middle length of the tank (See Figure 4).

If neither of the above conditions are met, then staging or an "other equivalent means" is to be provided for the survey of the under deck areas.

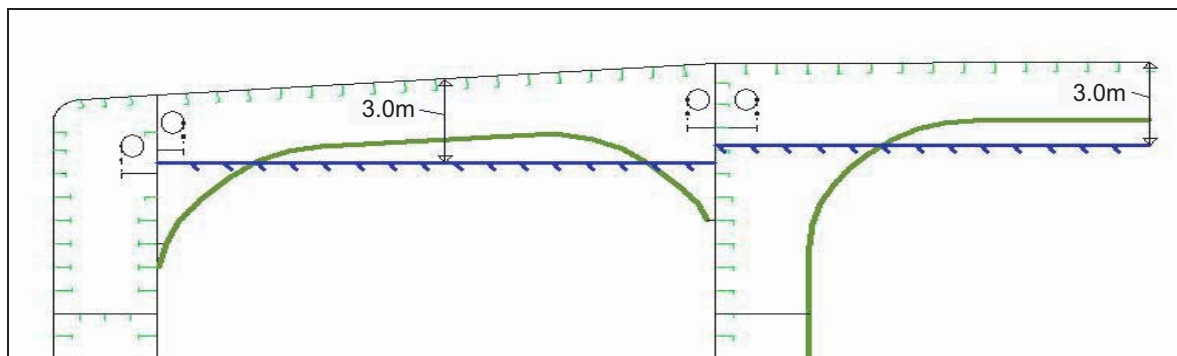

Figure 4

5.6.7

The use of rafts or boats alone in paragraphs 5.6.5 and 5.6.6 does not preclude the use of boats or rafts to move about within a tank during a survey.

Reference is made to IACS Recommendation 39 - Guidelines for the use of Boats or Rafts for Close-up surveys.

5.7 Survey Planning Meeting

5.7.1 Proper preparation and close co-operation between the attending surveyor(s) and the owner's representatives onboard prior to and during the survey are an essential part in the safe and efficient conduct of the survey. During the survey on board safety meetings are to be held regularly.

Z10.4
(cont'd)

5.7.2 Prior to the commencement of any part of the Special and Intermediate Survey a survey planning meeting is to be held between the attending Surveyor(s), the Owner's Representative in attendance, the TM company representative, where involved, and the master of the ship or an appropriately qualified representative appointed by the master or Company for the purpose of ascertaining that all the arrangements envisaged in the survey programme are in place, so as to ensure the safe and efficient conduct of the survey work to be carried out. See also 7.1.2.

5.7.3 The following is an indicative list of items that are to be addressed in the meeting:

- .1 schedule of the vessel (i.e. the voyage, docking and undocking manoeuvres, periods alongside, cargo and ballast operations etc.);
- .2 provisions and arrangements for thickness measurements (i.e. access, cleaning/de-scaling, illumination, ventilation, personal safety);
- .3 extent of the thickness measurements;
- .4 acceptance criteria (refer to the list of minimum thicknesses);
- .5 extent of close-up survey and thickness measurement considering the coating condition and suspect areas/areas of substantial corrosion;
- .6 execution of thickness measurements;
- .7 taking representative readings in general and where uneven corrosion/pitting is found;
- .8 mapping of areas of substantial corrosion; and
- .9 communication between attending surveyor(s) the thickness measurement company operator(s) and owner representative(s) concerning findings.

Z10.4

(cont'd)

6. DOCUMENTATION ON BOARD**6.1 General**

6.1.1

The owner is to obtain, supply and maintain on board documentation as specified in 6.2 and 6.3, which is to be readily available for the Surveyor.

6.1.2

The documentation is to be kept on board for the lifetime of the ship.

6.1.3

For tankers and bulk carriers subject to SOLAS Chapter II-1 Part A-1 Regulation 3-10, the Owner is to arrange the updating of the Ship Construction File (SCF) throughout the ship's life whenever a modification of the documentation included in the SCF has taken place. Documented procedures for updating the SCF are to be included within the Safety Management System.

6.2 Survey report file

6.2.1

A Survey Report File is to be a part of the documentation on board consisting of:

- reports of structural surveys;
- Executive Hull Summary;
- thickness measurement reports.

6.2.2

The Survey Report File is to be available also in the Owner's and the Classification Society's management offices.

6.3 Supporting documents

6.3.1

The following additional documentation is to be available onboard:

- Survey Programme as required by 5.1 until such time as the Special Survey or Intermediate Survey, as applicable, has been completed;
- main structural plans of cargo and ballast tanks (for CSR ships these plans are to include for each structural element both the as-built and renewal thickness. Any thickness for voluntary addition is also to be clearly indicated on the plans. The Midship Section plan to be supplied on board the ship is to include the minimum allowable hull girder sectional properties for the tank transverse section in all cargo tanks);
- previous repair history;
- cargo and ballast history;
- extent of use of inert gas plant and tank cleaning procedures;

Z10.4

(cont'd)

- inspections by ship's personnel with reference to
 - structural deterioration in general;
 - leakage in bulkheads and piping;
 - condition of coating or corrosion prevention system, if any.
- any other information that will help identify Critical Structural Areas and/or Suspect Areas requiring inspection;

6.3.2

For tankers and bulk carriers subject to SOLAS Chapter II-1 Part A-1 Regulation 3-10, the Ship Construction File (SCF), limited to the items to be retained on board, is to be available on board.

6.4 Review of documentation on board**6.4.1**

Prior to survey, the Surveyor is to examine the completeness of the documentation onboard, and its contents as a basis for the survey.

6.4.2

For tankers and bulk carriers subject to SOLAS Chapter II-1 Part A-1 Regulation 3-10, on completion of the survey, the surveyor is to verify that the update of the Ship Construction File (SCF) has been done whenever a modification of the documentation included in the SCF has taken place.

6.4.3

For tankers and bulk carriers subject to SOLAS Chapter II-1 Part A-1 Regulation 3-10, on completion of the survey, the surveyor is to verify any addition and/or renewal of materials used for the construction of the hull structure are documented within the Ship Construction File inventory list.

Z10.4
(cont'd)**7. PROCEDURES FOR THICKNESS MEASUREMENT****7.1 General**

7.1.1

The required thickness measurements, if not carried out by the Society itself, are to be witnessed by a Surveyor of the Society. The Surveyor is to be on board to the extent necessary to control the process.

7.1.2

The thickness measurement company is to be part of the survey planning meeting to be held prior to commencing the survey.

7.1.3

Thickness measurements of structures in areas where close-up surveys are required shall be carried out simultaneously with close-up surveys.

7.1.4

In all cases the extent of the thickness measurements are to be sufficient as to represent the actual average condition.

7.2 Certification of thickness measurement company

7.2.1

The thickness measurement is to be carried out by a qualified company certified by the Classification Society according to principles stated in Table VII.

7.3 Number and locations of measurements

7.3.1 Application

The item 7.3 only applies to vessels built under the IACS Common Structural Rules of Double Hull Oil Tankers. For vessels not built under IACS Common Structural Rules, the requirements for number and locations of measurements are according to the Rules of the individual Classification Society and/or specific IACS URs depending on ship's age and structural elements concerned.

7.3.2 Number of measurements

Considering the extent of thickness measurements according to the different structural elements of the ship and surveys (special, intermediate and annual), the locations of the points to be measured are given for the most important items of the structure.

7.3.3 Locations of measurements

Table 1 provides explanations and/or interpretations for the application of those requirements indicated in the Rules, which refer to both systematic thickness measurements related to the calculation of global hull girder strength and specific measurements connected to close-up surveys.

Fig 5 to Fig 8 are provided to facilitate the explanations and/or interpretations given in Table 1, to show typical arrangements of double hull oil tankers.

Z10.4

(cont'd)

Table 1: Interpretations of rule requirements for the locations and number of points to be measured

Item	Interpretation	Figure reference
Selected plates	«Selected» means at least a single point on one out of three plates, to be chosen on representative areas of average corrosion.	
Deck, bottom plates and wind-and-water strakes	At least two points on each plate to be taken either at each 1/4 extremity of plate or at representative areas of average corrosion.	
Transverse section	<p>Measurements to be taken on all longitudinal members such as plating, longitudinals and girders at the deck, side, bottom, longitudinal bulkheads, inner bottom and hopper. One point to be taken on each plate. Both web and flange to be measured on longitudinals, if applicable.</p> <p>For tankers older than 10 years of age:</p> <p>within 0.1D (where D is the ship's moulded depth) of the deck and bottom at each transverse section to be measured, every longitudinal and girder is to be measured on the web and face plate, and every plate is to be measured at one point between longitudinals.</p>	Fig 5
Transverse rings (#) in cargo and ballast tanks	<p>At least two points on each plate in a staggered pattern and two points on the corresponding flange where applicable. Minimum 4 points on the first plate below deck. Additional points in way of curved parts. At least one point on each of two stiffeners between stringers / longitudinal</p>	Fig 6

Z10.4

(cont'd)

Item	Interpretation	Figure reference
Transverse bulkheads in cargo tanks	<p>girders.</p> <p>At least two points on each plate. Minimum 4 points on the first plate below main deck.</p> <p>At least one point on every third stiffener to be taken between each stringer.</p> <p>At least two points on each plate of stringers and girders, and two points on the corresponding flange. Additional points in way of curved part.</p> <p>Two points of each diaphragm plate of stools if fitted.</p>	Fig 7
Transverse bulkheads in ballast tanks	<p>At least 4 points on plates between stringers / longitudinal girders, or per plate if stringers / girders not fitted.</p> <p>At least two points on each plate of stringers and girders, and two points on the corresponding flange. Additional points in way of curved part.</p> <p>At least one point on two stiffeners between each stringer / longitudinal girder.</p>	Fig 8
Adjacent structural members	On adjacent structural members one point per plate and one point on every third stiffener / longitudinal.	

(#°) Transverse rings means all transverse material appearing in a cross-section of the ship's hull, in way of a double bottom floor, vertical web and deck transverse (definition from CSR)

Z10.4
(cont'd)

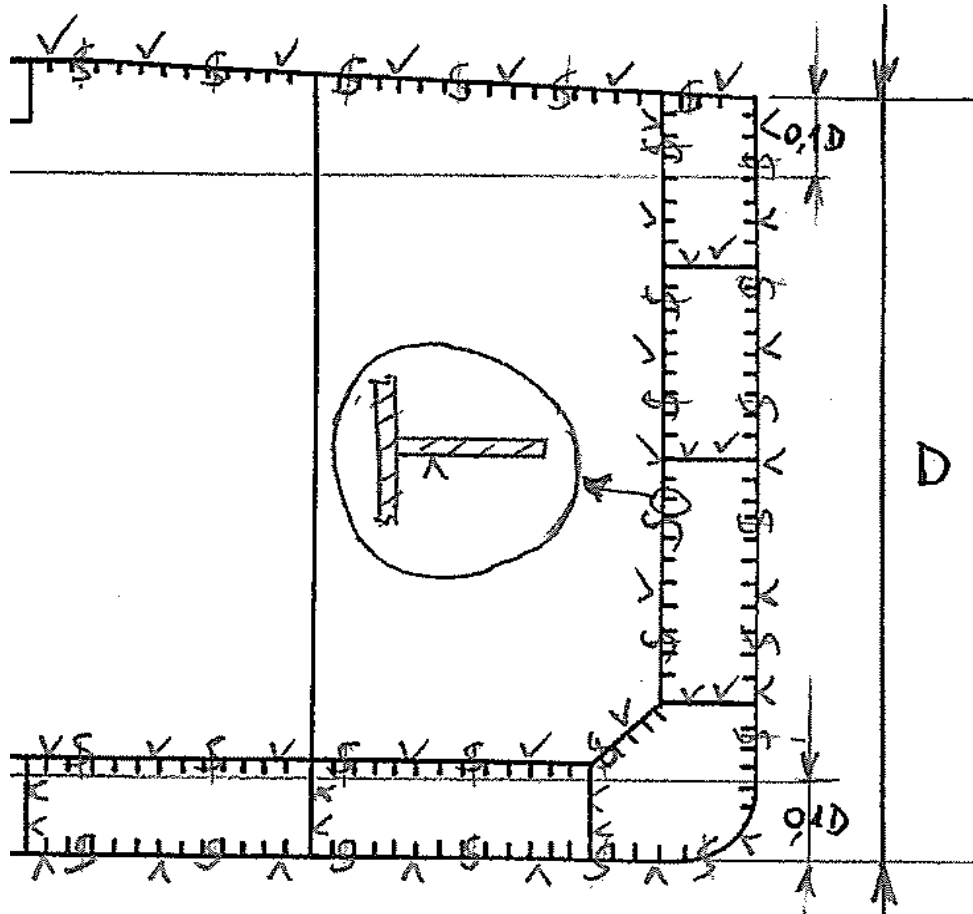

Figure 5 - Transverse section

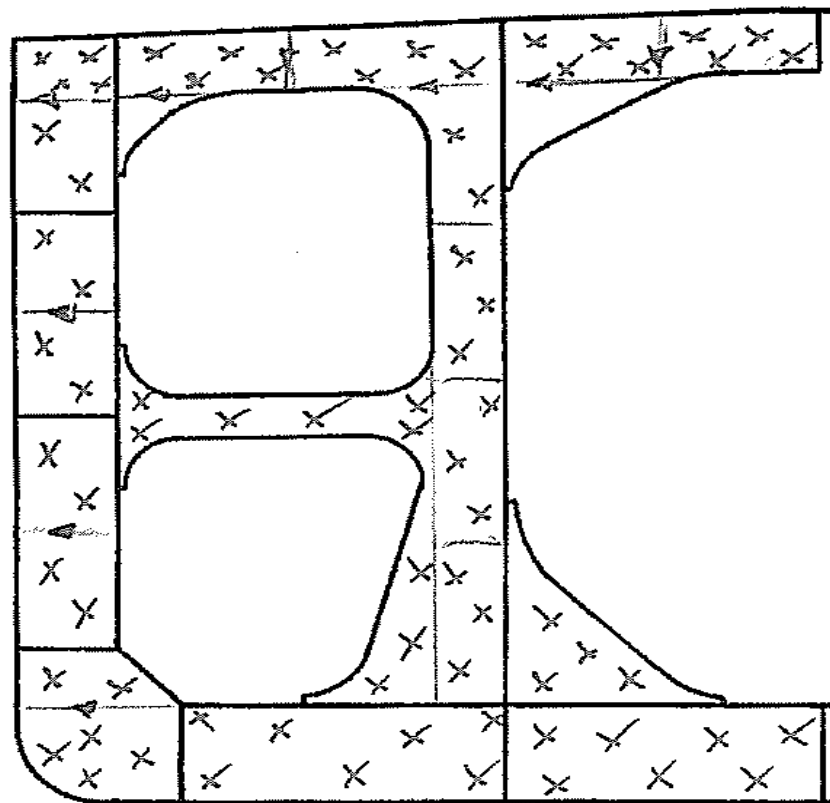

Figure 6 - Transverse rings in cargo and ballast tanks

Z10.4
(cont'd)

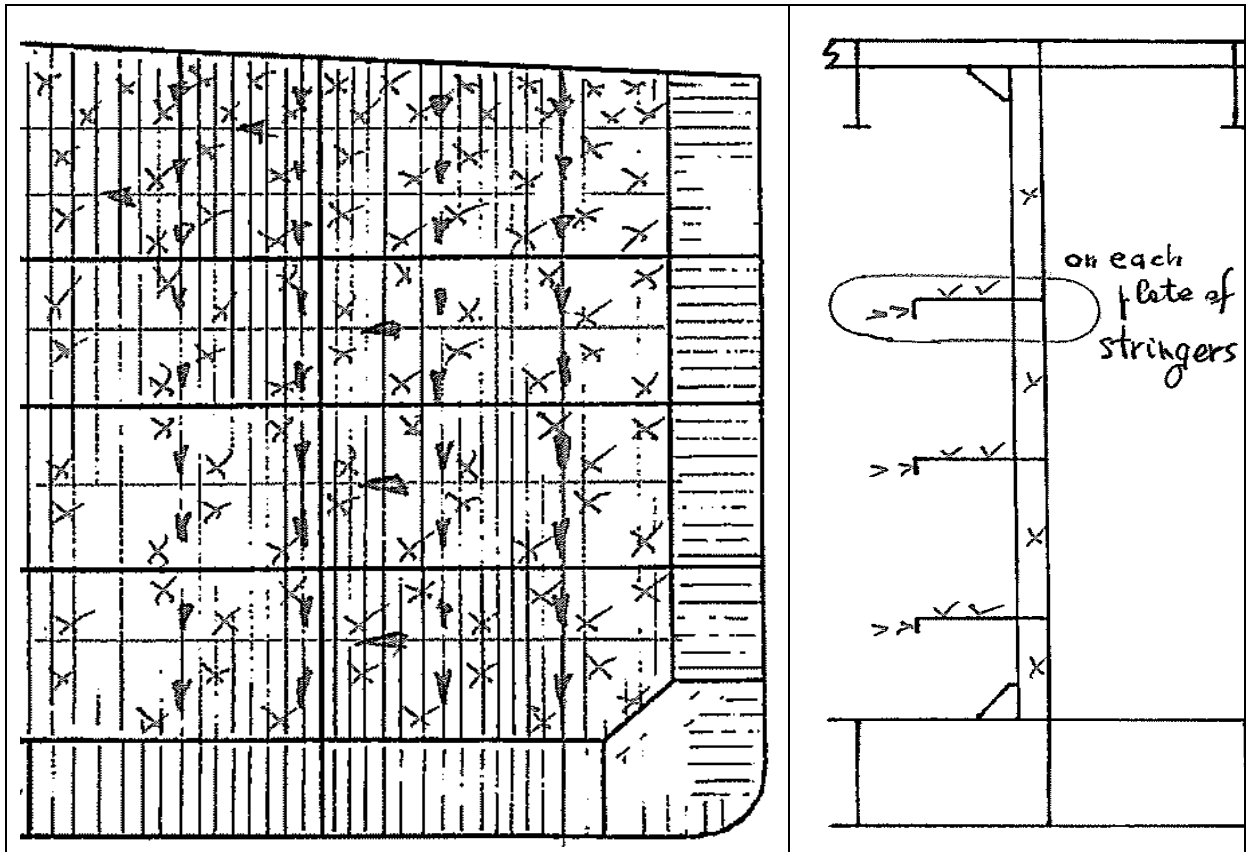

Figure 7 - Transverse bulkheads in cargo tanks

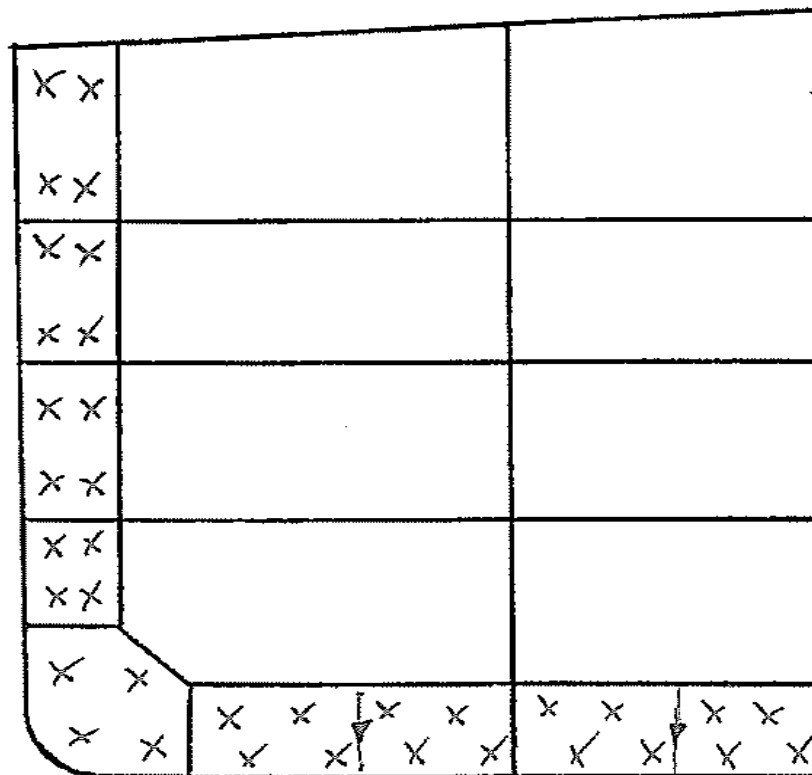

Figure 8 - Transverse bulkheads in ballast tanks

Z10.4

(cont'd)

7.4 Reporting

7.4.1

A thickness measurement report is to be prepared. The report is to give the location of measurement, the thickness measured as well as corresponding original thickness. Furthermore, the report is to give the date when the measurement was carried out, type of measuring equipment, names of personnel and their qualifications and has to be signed by the operator.

The thickness measurement report is to follow the principles as specified in the Recommended Procedures for Thickness Measurement of Double Hull Oil Tankers, contained in Annex II.

7.4.2

The Surveyor is to review the final thickness measurement report and countersign the cover page.

Z10.4

(cont'd)

8. ACCEPTANCE CRITERIA**8.1 General**

8.1.1 For vessels built under IACS Common Structural Rules, the Acceptance Criteria is according to Section 12 - Ship in Operation Renewal Criteria of IACS Common Structural Rules for Double Hull Oil Tankers and as specified in 8.2, 8.3 and 8.4.

8.1.2 For vessels not built under IACS Common Structural Rules, the Acceptance Criteria are according to the Rules of the individual Classification Society and/or specific IACS URs depending on ship's age and structural elements concerned.

8.2 Acceptance criteria for pitting corrosion of CSR ships

8.2.1 For plates with pitting intensity less than 20%, see Figure 1, the measured thickness, t_m , of any individual measurement is to meet the lesser of the following criteria:

$$t_m \geq 0.7 (t_{as-built} - t_{vol\ add}) \text{ mm}$$

$$t_m \geq t_{ren} - 1 \text{ mm}$$

Where:

$t_{as-built}$ as-built thickness of the member, in mm

$t_{vol\ add}$ voluntary thickness addition; thickness, in mm, voluntarily added as the Owner's extra margin for corrosion wastage in addition to t_c

t_{ren} renewal criteria for general corrosion as defined in 2.1.2.1 of Section 12 of CSRs for Oil Tankers

8.2.2 The average thickness across any cross section in the plating is not to be less than the renewal criteria for general corrosion given in 2.1.2.1 of Section 12 of CSRs for Oil Tankers.

8.3 Acceptance criteria for edge corrosion of CSR ships

8.3.1 Provided that the overall corroded height of the edge corrosion of the flange, or web in the case of flat bar stiffeners, is less than 25%, see Figure 2, of the stiffener flange breadth or web height, as applicable, the measured thickness, t_m , is to meet the lesser of the following criteria:

$$t_m \geq 0.7 (t_{as-built} - t_{vol\ add}) \text{ mm}$$

$$t_m \geq t_{ren} - 1 \text{ mm}$$

Where:

$t_{as-built}$ as-built thickness of the member, in mm

$t_{vol\ add}$ voluntary thickness addition; thickness, in mm, voluntarily added as the Owner's extra margin for corrosion wastage in addition to t_c

Z10.4

(cont'd)

t_{ren} renewal criteria for general corrosion as defined in 2.1.2.1 of Section 12 of CSRs for Oil Tankers

8.3.2 The average measured thickness across the breadth or height of the stiffener is not to be less than that defined in 2.1.2 of Section 12 of CSRs for Oil Tankers.

8.3.3 Plate edges at openings for manholes, lightening holes etc. may be below the minimum thickness given in 2.1.2 of Section 12 of CSRs for Oil Tankers provided that:

- a) the maximum extent of the reduced plate thickness, below the minimum given in 2.1.2 of Section 12 of CSRs for Oil Tankers, from the opening edge is not more than 20% of the smallest dimension of the opening and does not exceed 100mm.
- b) rough or uneven edges may be cropped-back provided that the maximum dimension of the opening is not increased by more than 10% and the remaining thickness of the new edge is not less than $t_{ren} - 1$ mm.

8.4 Acceptance criteria for grooving corrosion of CSR ships

8.4.1 Where the groove breadth is a maximum of 15% of the web height, but not more than 30mm, see Figure 3, the measured thickness, t_m , in the grooved area is to meet the lesser of the following criteria:

$$t_m \geq 0.75 (t_{as-built} - t_{vol add}) \text{ mm}$$

$$t_m \geq t_{ren} - 0.5 \text{ mm}$$

but is not to be less than

$$t_m = 6 \text{ mm}$$

Where:

$t_{as-built}$ as-built thickness of the member, in mm

$t_{vol add}$ voluntary thickness addition; thickness, in mm, voluntarily added as the Owner's extra margin for corrosion wastage in addition to t_c

t_{ren} renewal criteria for general corrosion as defined in 2.1.2.1 of Section 12 of CSRs for Oil Tankers

8.4.2 Structural members with areas of grooving greater than those in 8.4.1 are to be assessed based on the criteria for general corrosion as defined in 2.1.2 of Section 12 of CSRs for Oil Tankers using the average measured thickness across the plating/stiffener.

Z10.4
(cont'd)**9 REPORTING AND EVALUATION OF SURVEY****9.1 Evaluation of survey report**

9.1.1

The data and information on the structural condition of the vessel collected during the survey is to be evaluated for acceptability and continued structural integrity of the vessel.

9.1.1.1 In case of oil tankers of 130 m in length and upwards (as defined in the International Convention on Load Lines in force), the ship's longitudinal strength is to be evaluated by using the thickness of structural members measured, renewed and reinforced, as appropriate, during the special survey carried out after the ship reached 10 years of age in accordance with the criteria for longitudinal strength of the ship's hull girder for oil tankers specified in Annex III.

9.1.1.2 The final result of evaluation of the ship's longitudinal strength required in 9.1.1.1, after renewal or reinforcement work of structural members, if carried out as a result of initial evaluation, is to be reported as a part of the Executive Hull Summary.

9.2 Reporting

9.2.1

Principles for survey reporting are shown in Table VIII.

9.2.2

When a survey is split between different survey stations, a report is to be made for each portion of the survey. A list of items examined and / or tested (pressure testing, thickness measurements etc.) and an indication of whether the item has been credited, are to be made available to the next attending Surveyor(s), prior to continuing or completing the survey.

9.2.3

An Executive Hull Summary of the survey and results is to be issued to the Owner as shown in Table IX and placed on board the vessel for reference at future surveys. The Executive Hull Summary is to be endorsed by the Classification Society's head office or regional managerial office.

Z10.4

(cont'd)

TABLE I

**Minimum Requirements for Close-Up Survey
at Special Survey of Double Hull Oil Tankers**

Special Survey No.1 age ≤ 5	Special Survey No.2 5 < age ≤ 10	Special Survey No.3 10 < age ≤ 15	Special Survey No.4 and Subsequent age > 15
One web frame (1), in a ballast tank (see Note 1)	All web frames (1), in a ballast tank (see Note 1) The <i>knuckle area</i> and the upper part (5 metres approximately) of one web frame in each remaining ballast tank (6)	All web frames (1), in all ballast tanks	As for Special Survey for age from 10 to 15 years Additional transverse areas as deemed necessary by the Society
One deck transverse, in a cargo oil tank (2)	One deck transverse, in two cargo oil tanks (2)	All web frames (7), including deck transverse and cross ties, if fitted, in a cargo oil tank One web frame (7), including deck transverse and cross ties, if fitted, in each remaining cargo oil tank	
One transverse bulkhead (4), in a ballast tank (see Note 1)	One transverse bulkhead (4), in each ballast tank (see Note 1)	All transverse bulkheads, in all cargo oil (3) and ballast (4) tanks	
One transverse bulkhead (5), in a cargo oil centre tank	One transverse bulkhead (5), in two cargo oil centre tanks		
One transverse bulkhead (5), in a cargo oil wing tank (see Note 2)	One transverse bulkhead (5), in a cargo oil wing tank (see Note 2)		
<p>(1), (2), (3), (4), (5), (6) and (7) are areas to be subjected to close-up surveys and thickness measurements (see Figure 9 and Figure 10)</p> <p>(1): Web frame in a ballast tank means vertical web in side tank, hopper web in hopper tank, floor in double bottom tank and deck transverse in double deck tank (where fitted), including adjacent structural members. In fore and aft peak tanks web frame means a complete transverse web frame ring including adjacent structural members</p> <p>(2): Deck transverse, including adjacent deck structural members (or external structure on deck in way of the tank, where applicable)</p> <p>(3): Transverse bulkhead complete in cargo tanks, including girder system, adjacent structural members (such as longitudinal bulkheads) and internal structure of lower and upper stools, where fitted</p> <p>(4): Transverse bulkhead complete in ballast tanks, including girder system and adjacent structural members, such as longitudinal bulkheads, girders in double bottom tanks, inner bottom plating, hopper side, connecting brackets</p> <p>(5): Transverse bulkhead lower part in cargo tank, including girder system, adjacent structural members (such as longitudinal bulkheads) and internal structure of lower stool, where fitted</p> <p>(6): The <i>knuckle area</i> and the upper part (5 metres approximately), including adjacent structural members. <i>Knuckle area</i> is the area of the web frame around the connections of the slope hopper plating to the inner hull bulkhead and the inner bottom plating, up to 2 metres from the corners both on the bulkhead and the double bottom</p> <p>(7): Web frame in a cargo oil tank means deck transverse, longitudinal bulkhead vertical girder <u>structural elements</u> and cross ties, where fitted, including adjacent structural members</p> <p>Note 1: Ballast tank: means double bottom tank plus double side tank plus double deck tank, as applicable, even if these tanks are separate</p> <p>Note 2: Where no centre cargo tanks are fitted (as in case of centre longitudinal bulkhead), transverse bulkheads in wing tanks are to be surveyed</p>			

Z10.4

(cont'd)

TABLE II

**Minimum Requirements for Thickness Measurements
at Special Survey of Double Hull Oil Tankers**

Special Survey No.1 age ≤ 5	Special Survey No.2 5 < age ≤ 10	Special Survey No.3 10 < age ≤ 15	Special Survey No.4 and Subsequent age > 15
1. Suspect areas	1. Suspect areas	1. Suspect areas	1. Suspect areas
2. One section of deck plating for the full beam of the ship within the cargo area	2. Within the cargo area: .1 Each deck plate .2 One transverse section	2. Within the cargo area: .1 Each deck plate .2 Two transverse sections (1) .3 All wind and water strakes	2. Within the cargo area: .1 Each deck plate .2 Three transverse sections (1) .3 Each bottom plate
	3. Selected wind and water strakes outside the cargo area	3. Selected wind and water strakes outside the cargo area	3. All wind and water strakes, full length
4. Measurements, for general assessment and recording of corrosion pattern, of those structural members subject to close-up survey according to Table I.	4. Measurements, for general assessment and recording of corrosion pattern, of those structural members subject to close-up survey according to Table I.	4. Measurements, for general assessment and recording of corrosion pattern, of those structural members subject to close-up survey according to Table I.	4. Measurements, for general assessment and recording of corrosion pattern, of those structural members subject to close-up survey according to Table I.
(1): at least one section is to include a ballast tank within 0.5L amidships.			

Z10.4

(cont'd)

TABLE III

Minimum Requirements for Tank Testing at Special Survey of Double Hull Oil Tankers

Age of ship (in years at time of special survey due date)	
Special Survey No.1 age \leq 5	Special Survey No.2 and Subsequent age $>$ 5
All ballast tank boundaries	All ballast tank boundaries
Cargo tank boundaries facing ballast tanks, void spaces, pipe tunnels, pump rooms or cofferdams	All cargo tank bulkheads

Z10.4

(cont'd)

TABLE IV / Sheet 1

Requirements for extent of Thickness Measurements at those areas of substantial corrosion - Special Survey of Double Hull Oil Tankers within the Cargo Area Length

BOTTOM, INNER BOTTOM AND HOPPER STRUCTURE		
Structural member	Extent of measurement	Pattern of measurement
Bottom, inner bottom and hopper structure plating	Minimum of three bays across double bottom tank, including aft bay Measurements around and under all suction bell mouths	5-point pattern for each panel between longitudinals and floors
Bottom, inner bottom and hopper structure longitudinals	Minimum of three longitudinals in each bay where bottom plating measured	Three measurements in line across the flange and three measurements on vertical web
Bottom girders, including the watertight ones	At fore and aft watertight floors and in centre of tanks	Vertical line of single measurements on girder plating with one measurement between each panel stiffener, or a minimum of three measurements
Bottom floors, including the watertight ones	Three floors in the bays where bottom plating measured, with measurements at both ends and middle	5-point pattern over two square metre area
Hopper structure web frame ring	Three floors in bays where bottom plating measured	5-point pattern over one square metre of plating. Single measurements on flange
Hopper structure transverse watertight bulkhead or swash bulkhead	- lower 1/3 of bulkhead	- 5-point pattern over one square metre of plating
	- upper 2/3 of bulkhead	- 5-point pattern over two square metre of plating
	- stiffeners (minimum of three)	- For web, 5-point pattern over span (two measurements across web at each end and one at centre of span). For flange, single measurements at each end and centre of span
Panel stiffening	Where applicable	Single measurements

Z10.4

(cont'd)

TABLE IV / Sheet 2

Requirements for extent of Thickness Measurements at those areas of substantial corrosion - Special Survey of Double Hull Oil Tankers within the Cargo Area Length

DECK STRUCTURE		
Structural member	Extent of measurement	Pattern of measurement
Deck plating	Two transverse bands across tank	Minimum of three measurements per plate per band
Deck longitudinals	Every third longitudinal in each of two bands with a minimum of one longitudinal	Three measurements in line vertically on webs and two measurements on flange (if fitted)
Deck girders and brackets (usually in cargo tanks only)	At fore and aft transverse bulkhead, bracket toes and in centre of tanks	Vertical line of single measurements on web plating with one measurement between each panel stiffener, or a minimum of three measurements. Two measurements across flange. 5-point pattern on girder/bulkhead brackets
Deck transverse webs	Minimum of two webs, with measurements at both ends and middle of span	5-point pattern over one square metre area. Single measurements on flange
Vertical web and transverse bulkhead in wing ballast tank (two metres from deck)	Minimum of two webs, and both transverse bulkheads	5-point pattern over one square metre area
Panel stiffening	Where applicable	Single measurements

Z10.4

(cont'd)

TABLE IV / Sheet 3

Requirements for extent of Thickness Measurements at those areas of substantial corrosion - Special Survey of Double Hull Oil Tankers within the Cargo Area Length

STRUCTURE IN WING BALLAST TANKS		
Structural member	Extent of measurement	Pattern of measurement
Side shell and longitudinal bulkhead plating: <ul style="list-style-type: none"> - Upper strake and strakes in way of horizontal girders - All other strakes 	<ul style="list-style-type: none"> - Plating between each pair of longitudinals in a minimum of three bays (along the tank) - Plating between every third pair of longitudinals in same three bays 	<ul style="list-style-type: none"> - Single measurement - Single measurement
Side shell and longitudinal bulkhead longitudinals on: <ul style="list-style-type: none"> - Upper strake - All other strakes 	<ul style="list-style-type: none"> - Each longitudinal in same three bays - Every third longitudinal in same three bays 	<ul style="list-style-type: none"> - 3 measurements across web and 1 measurement on flange - 3 measurements across web and 1 measurement on flange
Longitudinals - brackets	Minimum of three at top, middle and bottom of tank in same three bays	5-point pattern over area of bracket
Vertical web and transverse bulkheads (excluding deckhead area): <ul style="list-style-type: none"> - Strakes in way of horizontal girders - Other strakes 	<ul style="list-style-type: none"> - Minimum of two webs and both transverse bulkheads - Minimum of two webs and both transverse bulkheads 	<ul style="list-style-type: none"> - 5-point pattern over approx. two square metre area - Two measurements between each pair of vertical stiffeners
Horizontal girders	Plating on each girder in a minimum of three bays	Two measurements between each pair of longitudinal girder stiffeners
Panel stiffening	Where applicable	Single measurements

Z10.4

(cont'd)

TABLE IV / Sheet 4

**Requirements for extent of Thickness Measurements at those areas of
substantial corrosion - Special Survey of Double Hull Oil
Tankers within the Cargo Area Length**

LONGITUDINAL BULKHEADS IN CARGO TANKS		
Structural Member	Extent of Measurement	Pattern of Measurement
Deckhead and bottom strakes, and strakes in way of the horizontal stringers of transverse bulkheads	Plating between each pair of longitudinals in a minimum of three bays	Single measurement
All other strakes	Plating between every third pair of longitudinals in same three bays	Single measurement
Longitudinals on deckhead and bottom strakes	Each longitudinal in same three bays	Three measurements across web and one measurement on flange
All other longitudinals	Every third longitudinal in same three bays	Three measurements across web and one measurement on flange
Longitudinals - brackets	Minimum of three at top, middle and bottom of tank in same three bays	5-point pattern over area of bracket
Web frames and cross ties	Three webs with minimum of three locations on each web, including in way of cross tie connections	5-point pattern over approximately two square metre area of webs, plus single measurements on flanges of web frame and cross ties
Lower end brackets (opposite side of web frame)	Minimum of three brackets	5-point pattern over approximately two square metre area of brackets, plus single measurements on bracket flanges

Z10.4

(cont'd)

TABLE IV / Sheet 5

**Requirements for extent of Thickness Measurements at those areas of
substantial corrosion - Special Survey of Double Hull Oil
Tankers within the Cargo Area Length**

TRANSVERSE WATERTIGHT AND SWASH BULKHEADS IN CARGO TANKS		
Structural member	Extent of measurement	Pattern of measurement
Upper and lower stool, where fitted	<ul style="list-style-type: none"> - Transverse band within 25mm of welded connection to inner bottom/deck plating - Transverse band within 25mm of welded connection to shelf plate 	5-point pattern between stiffeners over one metre length
Deckhead and bottom strakes, and strakes in way of horizontal stringers	Plating between pair of stiffeners at three locations: approximately 1/4, 1/2 and 3/4 width of tank	5-point pattern between stiffeners over one metre length
All other strakes	Plating between pair of stiffeners at middle location	Single measurement
Strakes in corrugated bulkheads	Plating of each change of scantling at centre of panel and at flange of fabricated connection	5-point pattern over about one square metre of plating
Stiffeners	Minimum of three typical stiffeners	For web, 5-point pattern over span between bracket connections (two measurements across web at each bracket connection and one at centre of span). For flange, single measurements at each bracket toe and at centre of span
Brackets	Minimum of three at top, middle and bottom of tank	5-point pattern over area of bracket
Horizontal stringers	All stringers with measurements at both ends and middle	5-point pattern over one square metre area, plus single measurements near bracket toes and on flanges

Z10.4

(cont'd)

TABLE V

Minimum Requirements for Overall and Close-Up Survey and Thickness Measurements at Intermediate Survey of Double Hull Oil Tankers

Age of ship at time of intermediate survey due date		
5 < age ≤ 10	10 < age ≤ 15	age > 15
See 4.2.2	See 4.2.3	See 4.2.4
<u>Overall survey of Representative ballast tanks selected by the attending surveyor</u> (see 4.2.2)	<u>The requirements of the previous Special Survey</u> (see 4.2.3)	<u>The requirements of the previous Special Survey</u> (see 4.2.4)
<u>Suspect areas identified at previous surveys are to be examined</u> (see 4.2.2)		

Z10.4
(cont'd)

Figure 9 - Close-up Survey Requirements for Double Hull Oil Tankers Areas (1) to (5)

Z10.4

(cont'd)

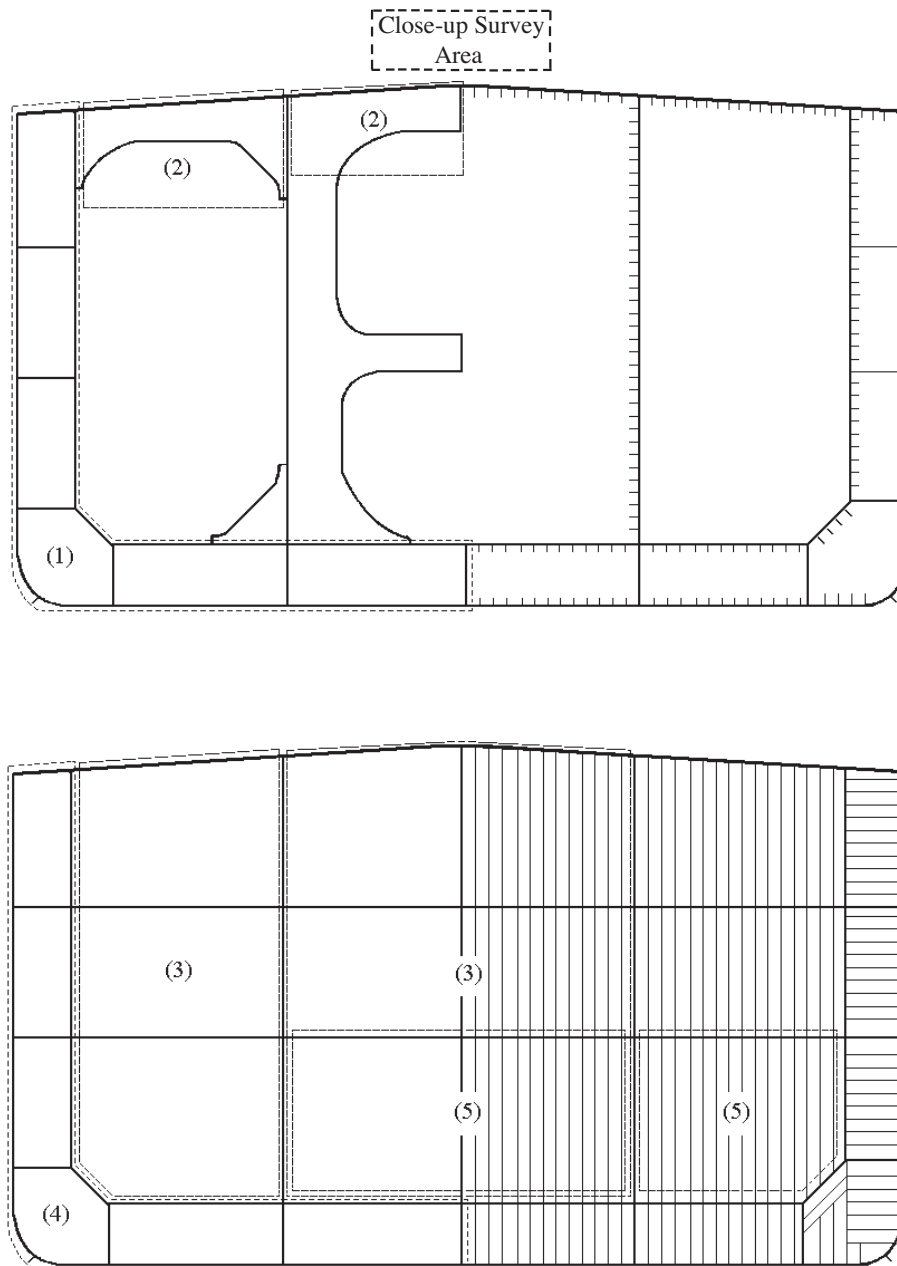
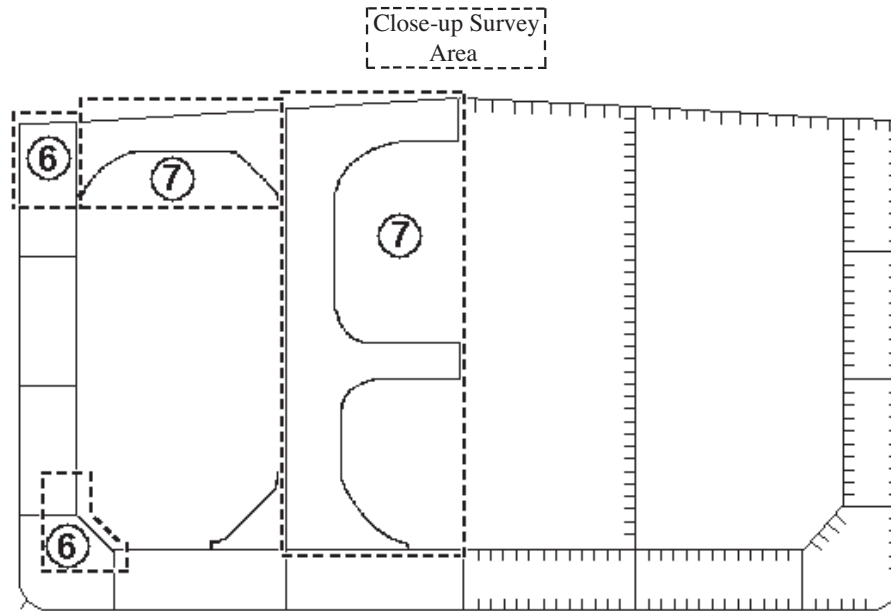

Figure 10 - Close-up Survey Requirements for Double Hull Oil Tankers Areas (6) and (7)

Z10.4

(cont'd)

TABLE VI

Note: Table VI is superseded by Annex I: Guidelines for Technical Assessment in conjunction with planning for Enhanced Surveys of Double Hull Oil Tankers Special Survey – Hull.

Z10.4

(cont'd)

TABLE VII

PROCEDURES FOR CERTIFICATION OF FIRMS ENGAGED IN THICKNESS MEASUREMENT OF HULL STRUCTURES**1. Application**

This guidance applies for certification of the firms which intend to engage in the thickness measurement of hull structures of the vessels.

2. Procedures for Certification**(1) Submission of Documents:**

Following documents are to be submitted to the society for approval;

- a) Outline of firms, e.g. organization and management structure.
- b) Experience of the firms on thickness measurement inter alia of hull structures of the vessels.
- c) Technicians' careers, i.e. experience of technicians as thickness measurement operators, technical knowledge of hull structure etc. Operators, are to be qualified according to a recognized industrial NDT Standard.
- d) Equipment used for thickness measurement such as ultra-sonic testing machines and its maintenance/calibration procedures.
- e) A guide for thickness measurement operators.
- f) Training programmes of technicians for thickness measurement.
- g) Measurement record format in accordance with the Recommended Procedures for Thickness Measurements of Double Hull Oil Tankers contained in Annex II.

(2) Auditing of the firms:

Upon reviewing the documents submitted with satisfactory results, the firm is audited in order to ascertain that the firm is duly organized and managed in accordance with the documents submitted, and eventually is capable of conducting thickness measurement of the hull construction of the ships.

(3) Certification is conditional on an onboard demonstration at thickness measurements as well as satisfactory reporting.**3. Certification**

(1) Upon satisfactory results of both the audit of the firm in 2(2) and the demonstration tests in 2(3) above, the Society will issue a Certificate of Approval as well as a notice to the effect that the thickness measurement operation system of the firm has been certified by the Society.

(2) Renewal/endorsement of the Certificate is to be made at intervals not exceeding 3 years by verification that original conditions are maintained.

4. Information of any alteration to the Certified Thickness Measurement Operation System

In case where any alteration to the certified thickness measurement operation system of the firm is made, such an alteration is to be immediately informed to the Society. Re-audit is made where deemed necessary by the Society.

Z10.4

(cont'd)

5. Cancellation of Approval

Approval may be cancelled in the following cases:

- (1) Where the measurements were improperly carried out or the results were improperly reported.
- (2) Where the Society's surveyor found any deficiencies in the approved thickness measurement operation systems of the firm.
- (3) Where the firm failed to inform of any alteration in 4 above to the Society.

Z10.4

(cont'd)

TABLE VIII

SURVEY REPORTING PRINCIPLES

As a principle, for oil tankers subject to ESP, the surveyor is to include the following content in his report for survey of hull structure and piping systems, as relevant for the survey.

The structure of the reporting content may be different, depending on the report system for the respective Societies.

1. General

1.1 A survey report is to be generated in the following cases:

- In connection with commencement, continuation and / or completion of periodical hull surveys, i.e. annual, intermediate and special surveys, as relevant
- When structural damages / defects have been found
- When repairs, renewals or modifications have been carried out
- When condition of class (recommendation) has been imposed or deleted

1.2 The purpose of reporting is to provide:

- Evidence that prescribed surveys have been carried out in accordance with applicable classification rules
- Documentation of surveys carried out with findings, repairs carried out and condition of class (recommendation) imposed or deleted
- Survey records, including actions taken, which shall form an auditable documentary trail. Survey reports are to be kept in the survey report file required to be on board
- Information for planning of future surveys
- Information which may be used as input for maintenance of classification rules and instructions

1.3 When a survey is split between different survey stations, a report is to be made for each portion of the survey. A list of items surveyed, relevant findings and an indication of whether the item has been credited, is to be made available to the next attending surveyor, prior to continuing or completing the survey. Thickness measurement and tank testing carried out is also to be listed for the next surveyor.

2. Extent of the survey

2.1 Identification of compartments where an overall survey has been carried out.

2.2 Identification of locations, in each tank, where a close-up survey has been carried out, together with information of the means of access used.

2.3 Identification of locations, in each tank, where thickness measurement has been carried out.

Note: As a minimum, the identification of location of close-up survey and thickness measurement is to include a confirmation with description of individual structural members corresponding to the extent of requirements stipulated in Z10.4 based on type of periodical survey and the ship's age.

Where only partial survey is required, i.e. one web frame ring / one deck transverse, the identification is to include location within each tank by reference to frame numbers.

Z10.4 (cont'd)

2.4 For areas in tanks where protective coating is found to be in GOOD condition and the extent of close-up survey and / or thickness measurement has been specially considered, structures subject to special consideration are to be identified.

2.5 Identification of tanks subject to tank testing.

2.6 Identification of cargo piping on deck, including crude oil washing (COW) piping, and cargo and ballast piping within cargo and ballast tanks, pump rooms, pipe tunnels and void spaces, where:

- Examination including internal examination of piping with valves and fittings and thickness measurement, as relevant, has been carried out
- Operational test to working pressure has been carried out

3. Result of the survey

3.1 Type, extent and condition of protective coating in each tank, as relevant (rated GOOD, FAIR or POOR).

3.2 Structural condition of each compartment with information on the following, as relevant:

- Identification of findings, such as:
 - Corrosion with description of location, type and extent
 - Areas with substantial corrosion
 - Cracks / fractures with description of location and extent
 - Buckling with description of location and extent
 - Indents with description of location and extent
- Identification of compartments where no structural damages / defects are found

The report may be supplemented by sketches / photos.

3.3 Thickness measurement report is to be verified and signed by the surveyor controlling the measurements on board.

3.4 Evaluation result of longitudinal strength of the hull girder of oil tankers of 130 m in length and upwards and over 10 years of age. The following data is to be included, as relevant:

- Measured and as-built transverse sectional areas of deck and bottom flanges
- Diminution of transverse sectional areas of deck and bottom flanges
- Details of renewals or reinforcements carried out, as relevant (as per 4.2)

4. Actions taken with respect to findings

4.1 Whenever the attending surveyor is of the opinion that repairs are required, each item to be repaired is to be identified in the survey report. Whenever repairs are carried out, details of the repairs effected are to be reported by making specific reference to relevant items in the survey report.

Z10.4

(cont'd)

4.2 Repairs carried out are to be reported with identification of:

- Compartment
- Structural member
- Repair method (i.e. renewal or modification) including:
 - Steel grades and scantlings (if different from the original)
 - Sketches/photos, as appropriate
- Repair extent
- NDT / Tests

4.3 For repairs not completed at the time of survey, condition of class (recommendation) is to be imposed with a specific time limit for the repairs. In order to provide correct and proper information to the surveyor attending for survey of the repairs, condition of class (recommendation) is to be sufficiently detailed with identification of each item to be repaired. For identification of extensive repairs, reference may be given to the survey report.

Z10.4

(cont'd)

TABLE IX (i)

IACS UNIFIED REQUIREMENTS FOR ENHANCED SURVEYS EXECUTIVE HULL SUMMARY

Issued upon Completion of Special Survey

GENERAL PARTICULARS

SHIP'S NAME: CLASS IDENTIFY NUMBER:
IMO IDENTIFY NUMBER:
PORT OF REGISTRY: NATIONAL FLAG:
DEADWEIGHT (M. TONNES): GROSS TONNAGE:
NATIONAL:
ITC (69):
DATE OF BUILD: CLASSIFICATION NOTATION:
DATE OF MAJOR CONVERSION:
TYPE OF CONVERSION:

-
- a) The survey reports and documents listed below have been reviewed by the undersigned and found to be satisfactory
 - b) A summary of the survey is attached herewith on sheet 2
 - c) The hull special survey has been completed in accordance with the Regulations on [date]

Executive Summary Report completed by:	Name Signature	Title
OFFICE	DATE	
Executive Summary Report verified by:	Name Signature	Title
OFFICE	DATE	

Attached reports and documents:

- 1)
- 2)
- 3)
- 4)
- 5)
- 6)

Z10.4

(cont'd)

TABLE IX (ii)**EXECUTIVE HULL SUMMARY**

- | | | | |
|----|--|---------------------------|---|
| A) | General Particulars: | - | Ref. Table IX (i) |
| B) | Report Review: | - | Where and how survey was done |
| C) | Close-up Survey: | - | Extent (Which tanks) |
| D) | Cargo & Ballast
Piping System: | - | Examined |
| | | - | Operationally tested |
| E) | Thickness
measurements: | - | Reference to Thickness Measurement report |
| | | - | Summary of where measured |
| | | - | Separate form indicating the tanks/areas with
Substantial Corrosion, and corresponding |
| | | * | Thickness diminution |
| | | * | Corrosion pattern |
| F) | Tank Protection: | Separate form indicating: | |
| | | - | Location of coating |
| | | - | Condition of coating (if applicable) |
| G) | Repairs: | - | Identification of tanks/areas |
| H) | Condition of Class/Recommendations: | | |
| I) | Memoranda: | - | Acceptable defects |
| | | - | Any points of attention for future surveys, e.g. for
Suspect Areas. |
| | | - | Extended Annual/Intermediate survey due to coating
breakdown |
| J) | Evaluation results of the ship's longitudinal strength (for oil tankers of 130 m in length
and upwards and of over 10 years of age) | | |
| K) | Conclusion: | - | Statement on evaluation/verification of survey report |

Z10.4

(cont'd)

TABLE IX (iii) A – non CSR vessels
EXTRACT OF THICKNESS MEASUREMENT

Reference is made to the thickness measurements report:

1) Position of substantially corroded Tanks/Areas or Areas with deep pitting	Thickness diminution[%]	2) Corrosion pattern	Remarks: e.g. Ref. attached sketches

Remarks

- 1) Substantial corrosion, i.e. 75 – 100% of acceptable margins wasted.
- 2) P = Pitting
C = Corrosion in General
Any bottom plating with a pitting intensity of 20% or more, with wastage in the substantial corrosion range or having an average depth of pitting of 1/3 or more of actual plate thickness is to be noted.

Z10.4

(cont'd)

TABLE IX (iii) B – CSR vessels**EXTRACT OF THICKNESS MEASUREMENTS**

Reference is made to the thickness measurements report:

1) Position of substantially corroded Tanks/Areas or Areas with deep pitting	$t_m - t_{ren}$ (mm)	2) Corrosion pattern	Remarks: e.g. Ref. Attached sketches

Remarks

- 1) Substantial corrosion, an extent of corrosion such that the assessment of the corrosion pattern indicates a measured thickness between $t_{ren} + 0.5\text{mm}$ and t_{ren} .
- 2) P = Pitting
C = Corrosion in General
Areas with deep pitting assessed according to 8.2 are to be recorded in this column.

Z10.4

(cont'd)

TABLE IX (iv)
TANK PROTECTION

1) Tank Nos.	2) Tank protection	3) Coating condition	Remarks

Remarks:

1)

All segregated ballast tanks and combined cargo/ballast tanks to be listed.

2)

C = Coating NP = No Protection

3)

Coating condition according to the following standard

GOOD condition with only minor spot rusting.

FAIR condition with local breakdown at edges of stiffeners and weld connections and/or light rusting over 20% or more of areas under consideration, but less than as defined for POOR condition.

POOR condition with general breakdown of coating over 20% or more of areas or hard scale at 10% or more of areas under consideration.

If coating condition **less than "GOOD"** is given, extended annual surveys are to be introduced. This is to be noted in part I) of the Executive Hull Summary.

Z10.4

(cont'd)

TABLE IX (v)

**Evaluation result of longitudinal strength of the hull girder of
oil tankers of 130 m in length and upwards and of over 10 years of age
(Of sections 1, 2 and 3 below, only one applicable section is to be completed)**

1 This section applies to ships regardless of the date of construction: Transverse sectional areas of deck flange (deck plating and deck longitudinals) and bottom flange (bottom shell plating and bottom longitudinals) of the ship's hull girder have been calculated by using the thickness measured, renewed or reinforced, as appropriate, during the special survey most recently conducted after the ship reached 10 years of age, and found that the diminution of the transverse sectional area does not exceed 10% of the as-built area, as shown in the following table:

Table 1 Transverse sectional area of hull girder flange				
		Measured	As-built	Diminution
Transverse Section 1	Deck flange	cm ²	cm ²	cm ² (%)
	Bottom flange	cm ²	cm ²	cm ² (%)
Transverse Section 2	Deck flange	cm ²	cm ²	cm ² (%)
	Bottom flange	cm ²	cm ²	cm ² (%)
Transverse Section 3	Deck flange	cm ²	cm ²	cm ² (%)
	Bottom flange	cm ²	cm ²	cm ² (%)

2 This section applies to ships constructed on or after 1 July 2002: Section moduli of transverse section of the ship's hull girder have been calculated by using the thickness of structural members measured, renewed or reinforced, as appropriate, during the special survey most recently conducted after the ship reached 10 years of age in accordance with the provisions of paragraph 2.2.1.1 of Annex III, and are found to be within their diminution limits determined by the Classification Society*, as shown in the following table:

Table 2 Transverse section modulus of hull girder				
		Z _{act} (cm ³) ^{*1}	Z _{req} (cm ³) ^{*2}	Remarks
Transverse Section 1	Upper deck			
	Bottom			
Transverse Section 2	Upper deck			
	Bottom			
Transverse Section 3	Upper deck			
	Bottom			

* The actual transverse section modulus of the hull girder of oil tankers calculated under paragraph 2.2.1.1 of Annex III to UR Z10.4 is not to be less than 90% of the required section modulus for new buildings specified in IACS Unified Requirements S7* or S11, whichever is the greater.

* C = 1.0 c_n is to be used for the purpose of this calculation.

Z10.4

(cont'd)

Notes

- *1 Z_{act} means the actual section moduli of the transverse section of the ship's hull girder calculated by using the thickness of structural members measured, renewed or reinforced, as appropriate, during the special survey, in accordance with the provisions of paragraph 2.2.1.1 of Annex III.
- *2 Z_{req} means diminution limit of the longitudinal bending strength of ships, as calculated in accordance with the provisions of paragraph 2.2.1.1 of Annex III.

The calculation sheets for Z_{act} are to be attached to this report.

3 This section applies to ships constructed before 1 July 2002: Section moduli of transverse section of the ship's hull girder have been calculated by using the thickness of structural members measured, renewed or reinforced, as appropriate, during the special survey most recently conducted after the ship reached 10 years of age in accordance with the provisions of paragraph 2.2.1.2 of Annex III, and found to meet the criteria required by the Classification Society and that Z_{act} is not less than Z_{mc} (defined in *2 below) as specified in appendix 2 to Annex III, as shown in the following table:

Describe the criteria for acceptance of the minimum section moduli of the ship's hull girder for ships in service required by the Classification Society.

Table 3 Transverse section modulus of hull girder				
		Z_{act} (cm ³) *1	Z_{req} (cm ³) *2	Remarks
Transverse Section 1	Upper deck			
	Bottom			
Transverse Section 2	Upper deck			
	Bottom			
Transverse Section 3	Upper deck			
	Bottom			

Notes:

- *1 As defined in note *1 of Table 2.
- *2 Z_{mc} means the diminution limit of minimum section modulus calculated in accordance with provisions of paragraph 2.2.1.2 of Annex III.

End of Main Section

Z10.4

(cont'd)

ANNEX I**GUIDELINES FOR TECHNICAL ASSESSMENT IN CONJUNCTION WITH
PLANNING FOR ENHANCED SURVEYS OF DOUBLE HULL OIL TANKERS
SPECIAL SURVEY - HULL****Contents:**

- 1. INTRODUCTION**
- 2. PURPOSE AND PRINCIPLES**
 - 2.1 Purpose
 - 2.2 Minimum Requirements
 - 2.3 Timing
 - 2.4 Aspects to be Considered
- 3. TECHNICAL ASSESSMENT**
 - 3.1 General
 - 3.2 Methods
 - 3.2.1 Design Details
 - 3.2.2 Corrosion
 - 3.2.3 Locations for Close-up Survey and Thickness Measurement

REFERENCES

1. IACS Unified Requirement Z10.4, "Hull Surveys of Double Hull Oil Tankers."
2. TSCF, "Guidelines for the Inspection and Maintenance of Double Hull Tanker Structures, 1995."
3. TSCF, "Guidance Manual for Tanker Structures, 1997."

1. INTRODUCTION

These guidelines contain information and suggestions concerning technical assessments which may be of use in conjunction with the planning of enhanced special surveys of double hull oil tankers. As indicated in 5.1.5 of IACS Unified Requirement Z10.4, "Hull Surveys of Double Hull Oil Tankers," (Ref. 1), the guidelines are a recommended tool which may be invoked at the discretion of an IACS Member Society, when considered necessary and appropriate, in conjunction with the preparation of the required Survey Programme.

2. PURPOSE AND PRINCIPLES**2.1 Purpose**

The purpose of the technical assessments described in these guidelines is to assist in identifying critical structural areas, nominating suspect areas and in focusing attention on structural elements or areas of structural elements which may be particularly susceptible to, or evidence a history of, wastage or damage. This information may be useful in nominating locations, areas and tanks for thickness measurement, close-up survey and tank testing.

Critical Structural Areas are locations which have been identified from calculations to require monitoring or from the service history of the subject ship or from similar or sister ships (if available) to be sensitive to cracking, buckling or corrosion which would impair the structural integrity of the ship.

Z10.4 (cont'd)

2.2 Minimum Requirements

However, these guidelines may not be used to reduce the requirements pertaining to thickness measurement, close-up survey and tank testing contained in Tables I, II and III, respectively, of Z10.4; which are, in all cases, to be complied with as a minimum.

2.3 Timing

As with other aspects of survey planning, the technical assessments described in these guidelines are to be worked out by the Owner or operator in cooperation with the Classification Society well in advance of the commencement of the Special Survey, i.e., prior to commencing the survey and normally at least 12 to 15 months before the survey's completion due date.

2.4 Aspects to be Considered

Technical assessments, which may include quantitative or qualitative evaluation of relative risks of possible deterioration, of the following aspects of a particular ship may be used as a basis for the nomination of tanks and areas for survey:

- * Design features such as stress levels on various structural elements, design details and extent of use of high tensile steel.
- * Former history with respect to corrosion, cracking, buckling, indents and repairs for the particular ship as well as similar vessels, where available.
- * Information with respect to types of cargo carried, use of different tanks for cargo/ballast, protection of tanks and condition of coating, if any.

Technical assessments of the relative risks of susceptibility to damage or deterioration of various structural elements and areas are to be judged and decided on the basis of recognised principles and practices, such as may be found in publications of the Tanker Structure Cooperative Forum (TSCF), (Refs. 2 and 3).

3. TECHNICAL ASSESSMENT

3.1 General

There are three basic types of possible failure which may be the subject of technical assessment in connection with planning of surveys; corrosion, cracks and buckling. Contact damages are not normally covered by the survey plan since indents are usually noted in memoranda and assumed to be dealt with as a normal routine by Surveyors.

Technical assessments performed in conjunction with the survey planning process are, in principle to be as shown schematically in Figure 1, which depicts how technical assessments can be carried out in conjunction with the survey planning process. The approach is basically an evaluation of the risk based on the knowledge and experience related to design and corrosion.

The design is to be considered with respect to structural details which may be susceptible to buckling or cracking as a result of vibration, high stress levels or fatigue.

Corrosion is related to the ageing process, and is closely connected with the quality of corrosion protection at newbuilding, and subsequent maintenance during the service life. Corrosion may also lead to cracking and/or buckling.

3.2 Methods

3.2.1 Design Details

Damage experience related to the ship in question and similar ships, where available, is the main source of information to be used in the process of planning. In addition, a selection of structural details from the design drawings is to be included.

Z10.4

(cont'd)

- Typical damage experience to be considered will consist of:
- Number, extent, location and frequency of cracks.
 - Location of buckles.

This information may be found in the survey reports and/or the Owner's files, including the results of the Owner's own inspections. The defects should be analyzed, noted and marked on sketches.

In addition, general experience is to be utilized. For example, reference is to be made to the two TSCF's publications mentioned in Ref.2 and Ref.3, which contain a catalogue of typical damages and proposed repair methods for various tanker structural details.

Such figures are to be used together with a review of the main drawings, in order to compare with the actual structure and search for similar details which may be susceptible to damage. An example is shown in Figure 2. In particular, Chapter 3 of Ref.2 deals with various aspects specific to double hull tankers, such as stress concentration locations, misalignment during construction, corrosion trends, fatigue considerations and areas requiring special attention, which are to be considered in working out the survey planning.

The review of the main structural drawings, in addition to using the above mentioned figures, should include checking for typical design details where cracking has been experienced. The factors contributing to damage are to be carefully considered.

The use of high tensile steel (HTS) is an important factor. Details showing good service experience where ordinary, mild steel has been used may be more susceptible to damage when HTS, and its higher associated stresses, are utilized. There is extensive and, in general, good experience, with the use of HTS for longitudinal material in deck and bottom structures. Experience in other locations, where the dynamic stresses may be higher, is less favourable, e.g. side structures.

In this respect, stress calculations of typical and important components and details, in accordance with the latest Rules or other relevant methods, may prove useful and are to be considered.

The selected areas of the structure identified during this process are to be recorded and marked on the structural drawings to be included in the Survey Programme.

3.2.2 Corrosion

In order to evaluate relative corrosion risks, the following information is generally to be considered:

- Usage of Tanks and Spaces
- Condition of Coatings
- Cleaning Procedures
- Previous Corrosion Damage
- Ballast use and time for Cargo Tanks
- Corrosion Risk Scheme (See Ref. 3, Table 2.1)
- Location of Heated Tanks

Ref. 3 gives definitive examples which can be used for judging and describing coating condition, using typical pictures of conditions.

The evaluation of corrosion risks is to be based on information in Ref. 3, together with relevant information on the anticipated condition of the ship as derived from the information collected in order to prepare the Survey Programme and the age of the ship.

The various tanks and spaces are to be listed with the corrosion risks nominated accordingly.

Z10.4
(cont'd)

Special attention is to be given to the areas where the double hull tanker is particularly exposed to corrosion. To do this end, the specific aspects addressing corrosion in double hull tankers indicated in 3.4 (Corrosion trends) of Ref.2 are to be taken into account.

3.2.3 Locations for Close-up Survey and Thickness Measurement

On the basis of the table of corrosion risks and the evaluation of design experience, the locations for initial close-up survey and thickness measurement (areas and sections) may be nominated.

The sections subject to thickness measurement are to normally be nominated in tanks and spaces where corrosion risk is judged to be the highest.

The nomination of tanks and spaces for close-up survey should, initially, be based on highest corrosion risk, and should always include ballast tanks. The principle for the selection is to be that the extent is increased by age or where information is insufficient or unreliable.

Z10.4
(cont'd)

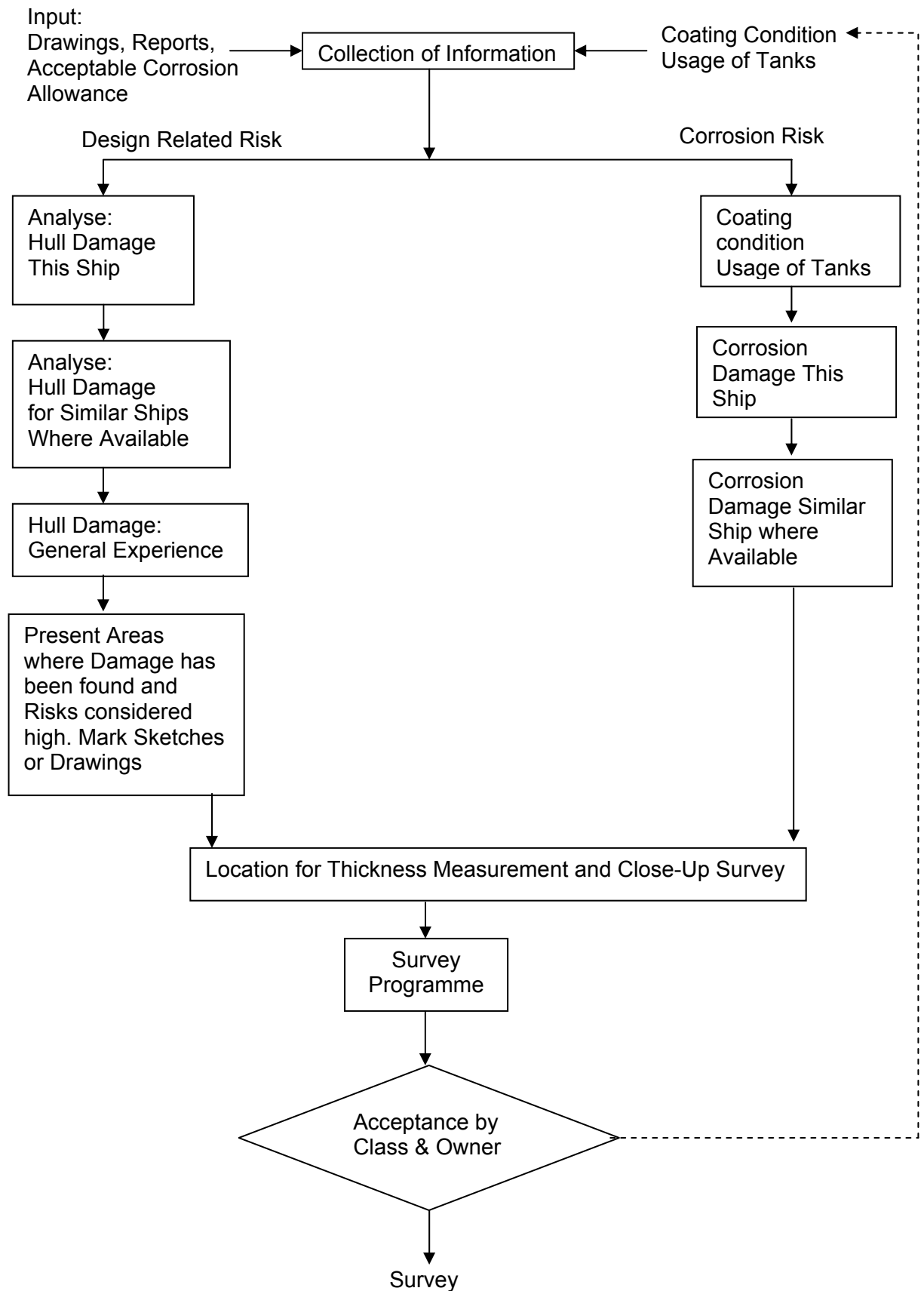

Figure 1: Technical Assessment and the Survey Planning Process

Z10.4
(cont'd)

<p>LOCATION: Connection of longitudinals to transverse webs</p> <p>EXAMPLE No. 1 : Web and flat bar fractures at cut-outs for longitudinal stiffener connections</p>		
<p>TYPICAL DAMAGE</p>		<p>PROPOSED REPAIR</p>
<p>Labels: * FRACTURE, SHELL PLATING OR LONGITUDINAL BULKHEAD, FLAT BAR STIFFENER, FRACTURED WELD/WEB, * FRACTURE, VIEW A - A, SIDE SHELL OR BULKHEAD LONGITUDINAL, WEB PLATING, * FRACTURE, WEB FLAT BAR STIFFENER.</p> <p>NOTE *ONE OR MORE FRACTURES MAY OCCUR</p>		<p>FULL COLLAR IF FRACTURES IN WEB PLATE ARE SMALL AND ARE REPAIRED BY WELDING</p> <p>Labels: LUG, VIEW A - A, BACKING BRACKET, LUG, $\geq X$, X.</p> <p>WEB AND FLAT BAR CROPPED AND PART RENEWED OR ALTERNATIVELY WELDED</p>
<p>FACTORS CONTRIBUTING TO DAMAGE</p> <ol style="list-style-type: none"> Asymmetrical connection of flat bar stiffener resulting in high peak stresses at the heel of the stiffener under fatigue loading. Insufficient area of connection of longitudinal to web plate. Defective weld at return around the plate thickness. High localised corrosion at areas of stress concentration such as flat bar stiffener connections, corners of cut-out for the longitudinal and connection of web to shell at cut-outs. High stress in the web of the transverse. Dynamic sea way load/ship motions. 		
<p>FIGURE 1</p>	<p>TANKER STRUCTURE CO-OPERATIVE FORUM</p> <p>SUBJECT: CATALOGUE OF STRUCTURAL DETAILS</p>	<p>FIGURE 1</p>

Figure 2: Typical Damage and Repair Example (Reproduced from Ref. 2)

End of Annex I

Z10.4
(cont'd)

ANNEX II

**RECOMMENDED PROCEDURES FOR THICKNESS MEASUREMENTS
OF DOUBLE HULL OIL TANKERS***

*

Note: Annex II is recommendatory.

CONTENTS

Z10.4

(cont'd)	Sheet 1	-	Contents
	Sheet 2	-	Instructions
	Sheet 3	-	General Particulars
	REPORTS		
	Sheet 4	-	Report TM1-DHT for recording the thickness measurements of all deck plating, all bottom shell plating and side shell plating
	Sheet 5	-	Report TM2-DHT (i) for recording the thickness measurement of shell and deck plating at transverse sections - strength deck and sheerstrake plating
	Sheet 6	-	Report TM2-DHT (ii) for recording the thickness measurement of shell and deck plating at transverse sections - shell plating
	Sheet 7	-	Report TM3-DHT for recording the thickness measurement of longitudinal members at transverse sections (including double hull plating)
	Sheet 8	-	Report TM4-DHT for recording the thickness measurement of transverse structural members
	Sheet 9	-	Report TM5-DHT for recording the thickness measurement of W.T./O.T. transverse bulkheads
	Sheet 10	-	Report TM6-DHT for recording the thickness measurement of miscellaneous structural members
	GUIDANCE		
	Sheet 11	-	Typical transverse section of a double hull oil tanker (up to 150,000 dwt). The diagram includes details of the items to be measured and the report forms to be used.
	Sheet 12	-	Typical transverse section of a double hull oil tanker (above 150,000 dwt). The diagram included details of the items to be measured and the report forms to be used.
	Sheet 13	-	Transverse section outline. The diagram may be used for those ships where the diagrams on sheet 11 and sheet 12 are not suitable
	Sheet 14	-	Transverse section and transverse bulkheads of a double hull oil tanker showing typical areas for thickness measurement in association with close-up survey requirements, areas (1) to (5) as defined in Table I of the UR Z10.4.
	Sheet 15	-	Transverse section of a double hull oil tanker showing typical areas for thickness measurement in association with close-up survey requirements, areas (6) to (7) as defined in Table I of the UR Z10.4.

Z10.4
(cont'd)**INSTRUCTIONS**

Sheet 2

**Recommended Procedures for Thickness Measurements of
Double Hull Oil Tankers**

1. This document is to be used for recording thickness measurements as required by IACS Unified Requirement Z10.4.
2. Reporting forms TM1-DHT, TM2-DHT, TM3-DHT, TM4-DHT, TM5-DHT and TM6-DHT (sheets 4-10) are to be used for recording thickness measurements and the maximum allowable diminution is to be stated.

The maximum allowable diminution could be stated in an attached document.

3. The remaining sheets 11-15 are guidance diagrams and notes relating to the reporting forms and the procedure for the thickness measurements.

GENERAL PARTICULARS

Sheet 3

Z10.4

(cont'd)

Ship's name:-

IMO Number:-

Class Identification number:-

Port of registry:-

Gross tons:-

Deadweight:-

Date of build:-

Classification society:-

Name of Company performing the thickness measurement:-

Thickness measurement company certified by:-

Certificate No.:-

Certificate valid from.....to.....

Place of measurement:-

First date of measurement:-

Last date of measurement:-

Special survey/intermediate survey due:-*

Details of measurement equipment:-

Qualification of operator:-

Report Number:-

Consisting of.....Sheets

Name of operator:-

Name of surveyor:-

Signature of operator:-

Signature of surveyor:-

Company official stamp:-

Classification Society
Official Stamp:-

* Delete as appropriate

Z10.4 TM1-DHT
(cont'd)

**Report on THICKNESS MEASUREMENT of ALL DECK PLATING, ALL BOTTOM SHELL PLATING
or SIDE SHELL PLATING*** (* - delete as appropriate)

Sheet 4

Ship's name.....

Class Identity No.

Report No.

STRAKE POSITION																	
PLATE POSITION	No. or Letter	Org. Thk. mm	Forward Reading						Aft Reading						Mean Diminution %		Maximum Allowable Diminution mm
			Gauged		Diminution P		Diminution S		Gauged		Diminution P		Diminution S		P	S	
			P	S	mm	%	mm	%	P	S	mm	%	mm	%			
12th forward																	
11th																	
10th																	
9th																	
8th																	
7th																	
6th																	
5th																	
4th																	
3rd																	
2nd																	
1st																	
Amidships																	
1st aft																	
2nd																	
3rd																	
4th																	
5th																	
6th																	
7th																	
8th																	
9th																	
10th																	
11th																	
12th																	

Operators Signature.....

NOTES – See Reverse

Z10.4**NOTES TO THE REPORT TM1-DHT**

(cont'd)

1. This report is to be used for recording the thickness measurement of:-
 - 1.1 All strength deck plating within the cargo area.
 - 1.2 All keel, bottom shell plating and bilge plating within the cargo area.
 - 1.3 Side shell plating including selected wind and water strakes outside cargo area.
 - 1.4 All wind and water strakes within cargo area.
2. The strake position is to be clearly indicated as follows:-
 - 2.1 For strength deck indicate the number of the strake of plating inboard from the stringer plate.
 - 2.2 For bottom plating indicate the number of the strake of plating outboard from the keel plate.
 - 2.3 For side shell plating give number of the strake of plating below sheerstrake and letter as shown on shell expansion.
3. Measurements are to be taken at the forward and aft areas of all and where plates cross ballast/cargo tank boundaries separate measurements for the area of plating in way of each type of tank are to be recorded.
4. The single measurements recorded are to represent the average of multiple measurements.
5. The maximum allowable diminution could be stated in an attached document.

Z10.4 TM2-DHT (i)
(cont'd)

**Report on THICKNESS MEASUREMENT OF SHELL AND DECK PLATING
(one, two or three transverse sections)**

Sheet 5

Ship's name.....

Class Identity No.

Report No.

STRENGTH DECK AND SHEERSTRAKE PLATING																												
STRAKE POSITION	FIRST TRANSVERSE SECTION AT FRAME NUMBER									SECOND TRANSVERSE SECTION AT FRAME NUMBER						THIRD TRANSVERSE SECTION AT FRAME NUMBER												
	No. or Letter	Org. Thk.	Max. Alwb. Dim.	Gauged		Diminution P		Diminution S		No. or Letter	Org. Thk.	Max. Alwb. Dim.	Gauged		Diminution P		Diminution S		No. or Letter	Org. Thk.	Max. Alwb. Dim.	Gauged		Diminution P		Diminution S		
				P	S	mm	%	mm	%				P	S	mm	%	mm	%				P	S	mm	%	mm	%	
Stringer Plate																												
1st strake inboard																												
2nd																												
3rd																												
4th																												
5th																												
6th																												
7th																												
8th																												
9th																												
10th																												
11th																												
12th																												
13th																												
14th																												
centre strake																												
sheer strake																												
TOPSIDE TOTAL																												

Operators Signature.....

NOTES – See Reverse

Z10.4

(cont'd)

NOTES TO THE REPORT TM2-DHT (i)

1. This report form is to be used for recording the thickness measurements of:

Strength deck plating and sheerstrake plating transverse sections:

One, two or three sections within the cargo area comprising of the structural items (0), (1) and (2) as shown on the diagrams of typical transverse sections illustrated on sheets 11 and 12 of this document.

2. The topside area comprises deck plating, stringer plate and sheerstrake (including rounded gunwales).
3. The exact frame station of measurement is to be stated.
4. The single measurements recorded are to represent the average of multiple measurements.
5. The maximum allowable diminution could be stated in an attached document.

Z10.4 TM2-DHT (ii)
(cont'd)

**Report on THICKNESS MEASUREMENT OF SHELL AND DECK PLATING
(one, two or three transverse sections)**

Sheet 6

Ship's name.....

Class Identity No.

Report No.

SHELL PLATING

STRAKE POSITION	FIRST TRANSVERSE SECTION AT FRAME NUMBER									SECOND TRANSVERSE SECTION AT FRAME NUMBER						THIRD TRANSVERSE SECTION AT FRAME NUMBER											
	No. or Letter	Org. Thk.	Max. Alwb. Dim.	Gauged		Diminution P		Diminution S		No. or Letter	Org. Thk.	Max. Alwb. Dim.	Gauged		Diminution P		Diminution S		No. or Letter	Org. Thk.	Max. Alwb. Dim.	Gauged		Diminution P		Diminution S	
				P	S	mm	%	mm	%				mm	%	P	S	mm	%				mm	%	P	S	mm	%
1st below sheer strake																											
2nd																											
3rd																											
4th																											
5th																											
6th																											
7th																											
8th																											
9th																											
10th																											
11th																											
12th																											
13th																											
14th																											
15th																											
16th																											
17th																											
18th																											
19th																											
20th																											
keel strake																											
BOTTOM TOTAL																											

Operators Signature.....

NOTES – See Reverse

Z10.4

(cont'd)

NOTES TO THE REPORT TM2-DHT (ii)

1. This report form is to be used for recording the thickness measurements of:

Shell plating transverse sections:

One, two or three sections within the cargo area comprising of the structural items (3), (4) and (5) and (6) as shown on the diagrams of typical transverse sections illustrated on sheets 11 and 12 of this document.

2. The bottom area comprises keel, bottom and bilge plating.
3. The exact frame station of measurement is to be stated.
4. The single measurements recorded are to represent the average of multiple measurements.
5. The maximum allowable diminution could be stated in an attached document.

Z10.4

(cont'd)

NOTES TO THE REPORT TM3-DHT

1. This report is to be used for recording the thickness measurements of:

Longitudinal Members at transverse sections:

One, two or three sections within the cargo area comprising of the appropriate structural items (10) to (29) as shown on the diagrams of typical transverse sections illustrated on sheets 11 and 12 of this document.
2. The exact frame station of measurement is to be stated.
3. The single measurements recorded are to represent the average of multiple measurements.
4. The maximum allowable diminution could be stated in an attached document.

Z10.4 TM4-DHT
(cont'd)

**Report on THICKNESS MEASUREMENT OF TRANSVERSE STRUCTURAL MEMBERS
In the cargo oil and water ballast tanks within the cargo tank length**

Sheet 8

Ship's name.....

Class Identity No.

Report No.

TANK DESCRIPTION:									
LOCATION OF STRUCTURE:									
STRUCTURAL MEMBER	ITEM	Original Thickness mm	Max. Alwb. Dim. mm	Gauged		Diminution P		Diminution S	
				P	S	mm	%	mm	%

Operators Signature.....

NOTES – See Reverse

Z10.4

(cont'd)

NOTES TO THE REPORT TM4-DHT

1. This report is to be used for recording the thickness measurements of:

 Transverse structural members, comprising of the appropriate structural items (30) to (36) as shown on diagrams of typical transverse sections illustrated on sheets 11 and 12 of this document.
2. Guidance for areas of measurement is indicated on sheet 14 and 15 of this document.

 The single measurements recorded are to represent the average of multiple measurements.
3. The maximum allowable diminution could be stated in an attached document.

Z10.4 TM5-DHT
(cont'd)

**Report on THICKNESS OF W.T./O.T. TRANSVERSE BULKHEADS
within the cargo tank or cargo hold spaces**

Sheet 9

Ship's name.....

Class Identity No.

Report No.

TANK/HOLD DESCRIPTION:								
LOCATION OF STRUCTURE:					FRAME NO.:			
STRUCTURAL COMPONENT (PLATING/STIFFENER)	Original Thickness mm	Max. Alwb. Dim. mm	Gauged		Diminution P		Diminution S	
			Port	Starboard	mm	%	mm	%

Operators Signature.....

NOTES – See Reverse

Z10.4

(cont'd)

NOTES TO THE REPORT TM5-DHT

1. This report is to be used for recording the thickness measurement of:
W.T./O.T. transverse bulkheads.
2. Guidance for areas of measurement is indicated on sheet 14 of this document.
3. The single measurements recorded are to represent the average of multiple measurements.
4. The maximum allowable diminution could be stated in an attached document.

Z10.4 TM6-DHT
(cont'd)

Report on THICKNESS MEASUREMENT OF MISCELLANEOUS STRUCTURAL MEMBERS

Sheet 10

Ship's name.....

Class Identity No.

Report No.

STRUCTURAL MEMBER:						SKETCH						
LOCATION OF STRUCTURE:												
Description	Org. Thk. mm	Max. Alwb. Dim. mm	Gauged		Diminution P					Diminution S		
			P	S	mm					%	mm	%

Operators Signature.....

NOTES – See Reverse

Z10.4

(cont'd)

NOTES TO THE REPORT TM6-DHT

1. This report is to be used for recording the thickness measurement of:
Miscellaneous structural members.
2. The single measurements recorded are to represent the average of multiple measurements.
3. The maximum allowable diminution could be stated in an attached document.

Thickness Measurement - Double Hull Oil Tankers

Typical transverse section of a double hull tanker up to 150,000 dwt with indication of longitudinal and transverse members

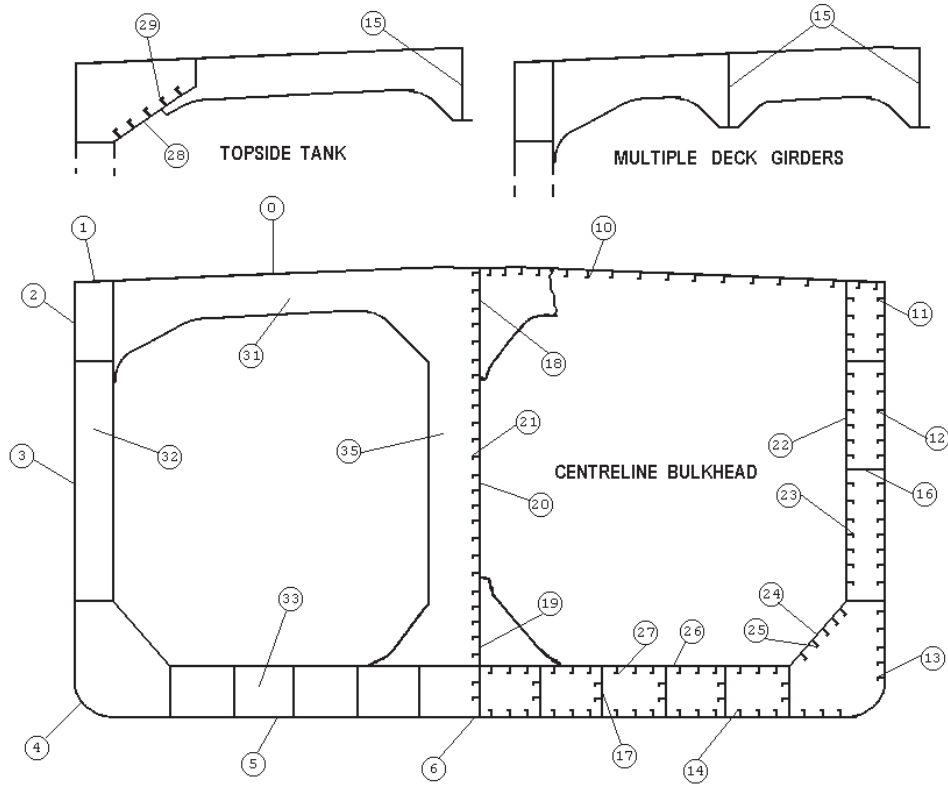

Report on TM2-DHT (i) & (ii)	
0.	Strength deck plating
1.	Stringer plate
2.	Sheerstrake
3.	Side shell plating
4.	Bilge plating
5.	Bottom shell plating
6.	Keel plate

Report on TM3-DHT			
10.	Deck longitudinals	20.	Longitudinal bulkhead plating (remainder)
11.	Sheerstrake longitudinals	21.	Longitudinal bulkhead longitudinals
12.	Side shell longitudinals	22.	Inner side plating
13.	Bilge longitudinals	23.	Inner side longitudinals
14.	Bottom longitudinals	24.	Hopper plating
15.	Deck girders	25.	Hopper longitudinals
16.	Horizontal girders in wing ballast tanks	26.	Inner bottom plating
17.	Bottom girders	27.	Inner bottom longitudinals
18.	Longitudinal bulkhead top strake	28.	Topside tank plating
19.	Longitudinal bulkhead bottom strake	29.	Topside tank longitudinals

Report on TM4-DHT	
30.	Deck transverse - centre tank
31.	Deck transverse - wing tank
32.	Vertical web in wing ballast tank
33.	Double bottom floor - wing tank
34.	Double bottom floor - centre tank
35.	Longitudinal bulkhead vertical web
36.	Cross ties

Thickness Measurement - Double Hull Oil Tankers

Typical transverse section of a double hull tanker above 150,000 dwt with indication of longitudinal and transverse members

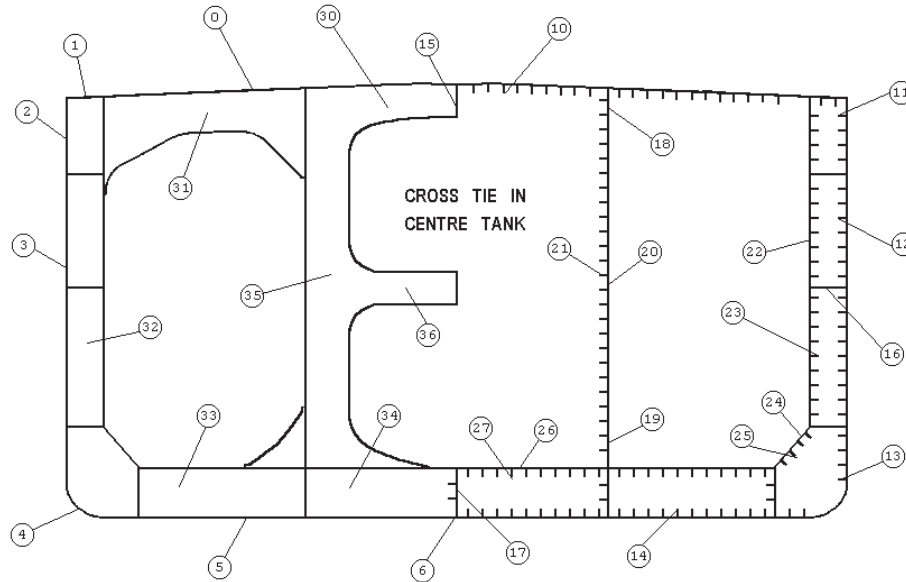

Report on TM2-DHT (i) & (ii)	
0.	Strength deck plating
1.	Stringer plate
2.	Sheerstrake
3.	Side shell plating
4.	Bilge plating
5.	Bottom shell plating
6.	Keel plate

Report on TM3-DHT			
10.	Deck longitudinals	20.	Longitudinal bulkhead plating (remainder)
11.	Sheerstrake longitudinals	21.	Longitudinal bulkhead longitudinals
12.	Side shell longitudinals	22.	Inner side plating
13.	Bilge longitudinals	23.	Inner side longitudinals
14.	Bottom longitudinals	24.	Hopper plating
15.	Deck girders	25.	Hopper longitudinals
16.	Horizontal girders in wing ballast tanks	26.	Inner bottom plating
17.	Bottom girders	27.	Inner bottom longitudinals
18.	Longitudinal bulkhead top strake	28.	Topside tank plating
19.	Longitudinal bulkhead bottom strake	29.	Topside tank longitudinals

Report on TM4-DHT	
30.	Deck transverse - centre tank
31.	Deck transverse - wing tank
32.	Vertical web in wing ballast tank
33.	Double bottom floor - wing tank
34.	Double bottom floor - centre tank
35.	Longitudinal bulkhead vertical web
36.	Cross ties

Thickness Measurement - Double Hull Oil Tankers
Transverse section outline

The diagram may be used for those ships where the diagrams on sheet 11
and sheet 12 are not suitable

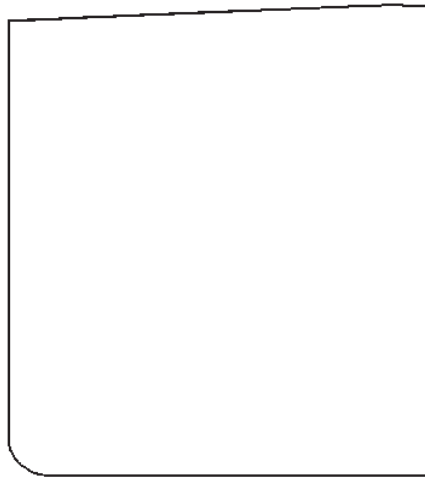

Report on TM2-DHT (i) & (ii)	
0.	Strength deck plating
1.	Stringer plate
2.	Sheerstrake
3.	Side shell plating
4.	Bilge plating
5.	Bottom shell plating
6.	Keel plate

Report on TM3-DHT			
10.	Deck longitudinals	20.	Longitudinal bulkhead plating (remainder)
11.	Sheerstrake longitudinals	21.	Longitudinal bulkhead longitudinals
12.	Side shell longitudinals	22.	Inner side plating
13.	Bilge longitudinals	23.	Inner side longitudinals
14.	Bottom longitudinals	24.	Hopper plating
15.	Deck girders	25.	Hopper longitudinals
16.	Horizontal girders in wing ballast tanks	26.	Inner bottom plating
17.	Bottom girders	27.	Inner bottom longitudinals
18.	Longitudinal bulkhead top strake	28.	Topside tank plating
19.	Longitudinal bulkhead bottom strake	29.	Topside tank longitudinals

Report on TM4-DHT	
30.	Deck transverse - centre tank
31.	Deck transverse - wing tank
32.	Vertical web in wing ballast tank
33.	Double bottom floor - wing tank
34.	Double bottom floor - centre tank
35.	Longitudinal bulkhead vertical web
36.	Cross ties

Z10.4
(cont'd)

Thickness Measurements - Double Hull Oil Tankers

Areas subject to close-up survey and thickness measurements - areas (1) to (5) as defined in Table I of UR Z10.4 - Thickness to be reported on TM3-DHT, TM4-DHT and TM5-DHT as appropriate

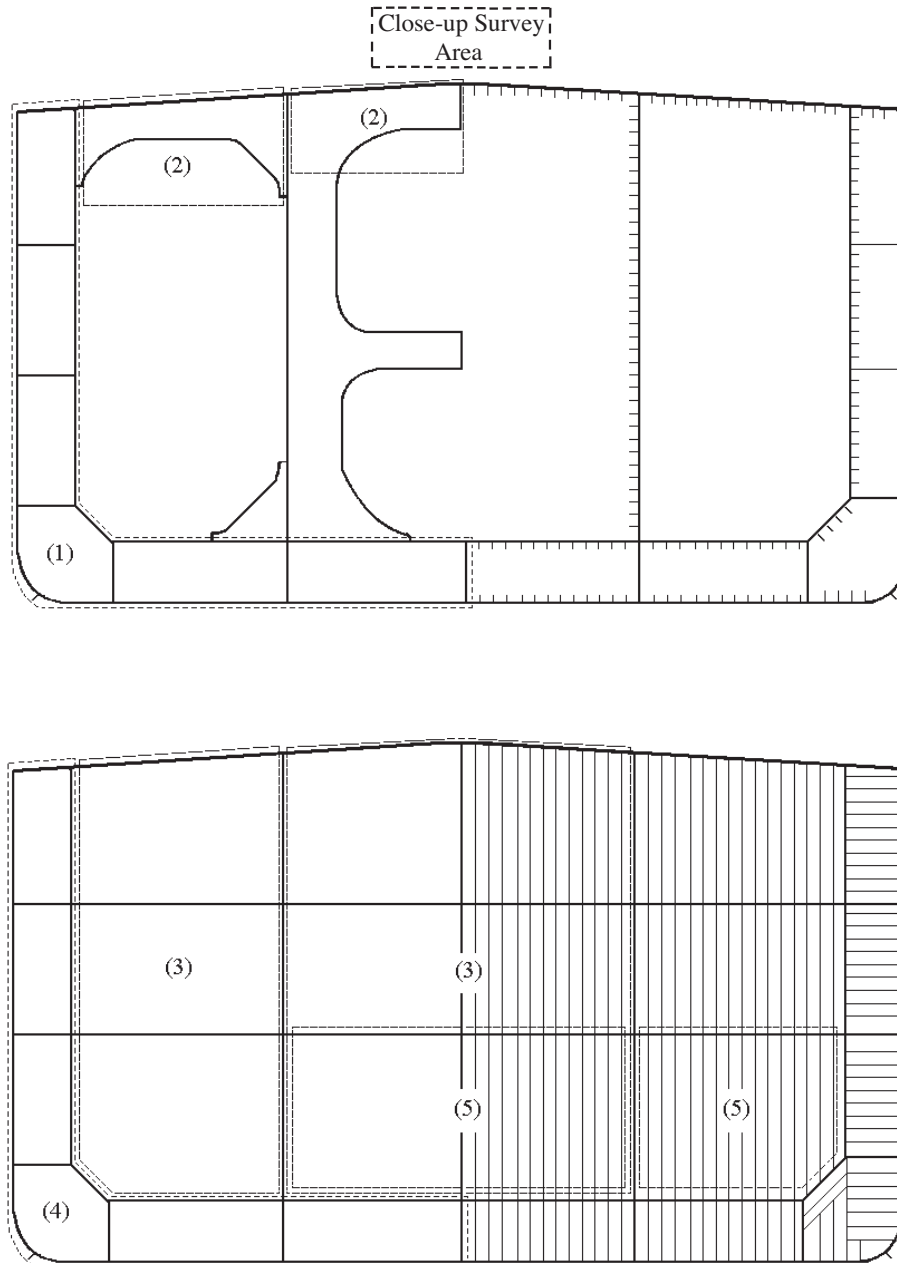

Z10.4
(cont'd)

Sheet 15

Thickness Measurements - Double Hull Oil Tankers

Areas subject to close-up survey and thickness measurements - areas (6) to (7) as defined in Table I of UR Z10.4 - Thickness to be reported on TM3-DHT and TM4-DHT as appropriate

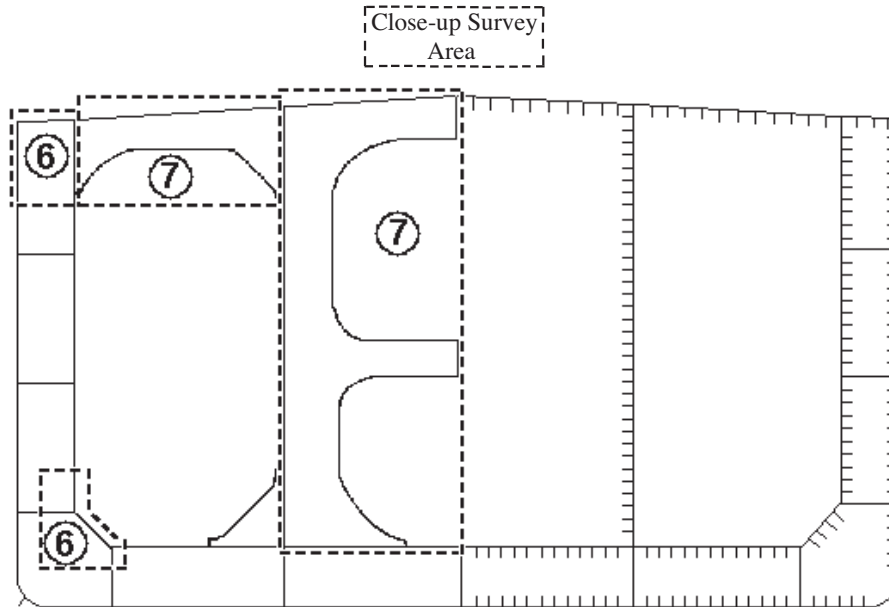

Z10.4

(cont'd)

ANNEX II (CSR)

**IACS RECOMMENDED PROCEDURES FOR THICKNESS MEASUREMENTS
OF DOUBLE HULL OIL TANKERS BUILT UNDER
IACS COMMON STRUCTURAL RULES***

*

Note: Annex II (CSR) is recommendatory.

Z10.4

(cont'd)

CONTENTS

Sheet 1

Sheet 1 - Contents

Sheet 2 - Instructions

Sheet 3 - General particulars

REPORTS

Sheet 4 - Report TM1-DHT(CSR) for recording the thickness measurement of all deck plating, all bottom plating and side shell plating

Sheet 5 - Report TM2-DHT(CSR) (i) for recording the thickness measurement of shell and deck plating at transverse sections - strength deck and sheerstrake plating

Sheet 6 - Report TM2-DHT(CSR) (ii) for recording the thickness measurement of shell plating at transverse sections

Sheet 7 - Report TM3-DHT(CSR) for recording the thickness measurement of longitudinal members at transverse sections (including double hull plating)

Sheet 8 - Report TM4-DHT(CSR) for recording the thickness measurement of transverse structural members

Sheet 9 - Report TM5-DHT(CSR) for recording the thickness measurement of W.T./O.T. transverse bulkheads

Sheet 10 - Report TM6-DHT(CSR) for recording the thickness measurement of miscellaneous structural members

GUIDANCE

Sheet 11 - Typical transverse section of a double hull oil tanker (up to 150,000 dwt). The diagram includes details of the items to be measured and the report forms to be used.

Sheet 12 - Typical transverse section of a double hull oil tanker (above 150,000 dwt). The diagram includes details of the items to be measured and the report forms to be used.

Sheet 13 - Transverse section outline. This diagram may be used for those ships where the diagram on sheet 11 and sheet 12 is not suitable.

Sheet 14 - Transverse section and transverse bulkheads of a double hull oil tanker showing typical areas for thickness measurement in association with close-up survey requirements, areas (1) to (5) as defined in Table I of the UR Z10.4.

Sheet 15 - Transverse section of a double hull oil tanker showing typical areas for thickness measurement in association with close-up survey requirements, areas (6) to (7) as defined in Table I of the UR Z10.4.

Z10.4

(cont'd)

INSTRUCTIONS

Sheet 2

**IACS Recommended Procedures for Thickness Measurements of
Double Hull Oil Tankers Built under IACS Common Structural Rules**

1. This document is to be used for recording thickness measurements of double hull oil tankers built under IACS Common Structural Rules as required by the IACS Unified Requirement Z10.4.
2. Reporting forms TM1-DHT(CSR), TM2-DHT(CSR) (i) and (ii), TM3-DHT(CSR), TM4-DHT(CSR), TM5-DHT(CSR) and TM6-DHT(CSR) (sheets 4-10) are to be used for recording thickness measurements. The as-built thickness and the voluntary thickness addition and renewal thickness (minimum allowable thickness) are to be stated in the said forms.
3. The remaining sheets 11-15 are guidance diagrams and notes relating to the reporting forms and the procedure for the thickness measurement.

Z10.4

(cont'd)

GENERAL PARTICULARS

Sheet 3

Ships name:-

IMO number:-

Class identity number:-

Port of registry:-

Gross tons:-

Deadweight:-

Date of build:-

Classification Society:-

Name of Company performing thickness measurement:-

Thickness measurement company certified by:-

Certificate No:-

Certificate valid from.....to.....

Place of measurement:-

First date of measurement:-

Last date of measurement:-

Special survey/intermediate survey due:-*

Details of measurement equipment:-

Qualification of operators:-

Report Number:-

consisting of.....Sheets

Name of operator:-

Name of surveyor:-

Signature of operator:-

Signature of surveyor:-

Company
Official Stamp:-Classification Society
Official Stamp:-

* Delete as appropriate

Z10.4 TM1-DHT(CSR)
(cont'd)

Report on THICKNESS MEASUREMENT of ALL DECK PLATING, ALL BOTTOM PLATING or SIDE SHELL PLATING*
(* - delete as appropriate)

Sheet 4

Ship's name.....

Class Identity No.....

Report No.....

STRAKE POSITION															
PLATE POSITION	No. or Letter	As Built Thk. mm	Voluntary Thickness Addition mm	Renewal Thickness mm (a)	Forward Reading				Aft Reading				Mean Remaining Corr. Addition, mm		
					Gauged Thk. mm (b1)		Remaining Corr. Addition, mm (c1)=(b1)-(a)		Gauged Thk. mm (b2)		Remaining Corr. Addition, mm (c2)=(b2)-(a)		[(c1)+(c2)]/2		
					P	S	P	S	P	S	P	S	P	S	
12th forward															
11th															
10th															
9th															
8th															
7th															
6th															
5th															
4th															
3rd															
2nd															
1st															
Amidships															
1st aft															
2nd															
3rd															
4th															
5th															
6th															
7th															
8th															
9th															
10th															
11th															
12th															

Operators Signature.....

NOTES – See Reverse

Z10.4

(cont'd)

NOTES TO REPORT TM1-DHT(CSR)

1. This report is to be used for recording the thickness measurement of:-
 - 1.1 All strength deck plating within the cargo length area.
 - 1.2 All keel, bottom shell plating and bilge plating within the cargo length area.
 - 1.3 Side shell plating including selected wind and water strakes outside the cargo length area.
 - 1.4 All wind and water strakes within the cargo length area.
2. The strake position is to be clearly indicated as follows:-
 - 2.1 For strength deck indicate the number of the strake of plating inboard from the stringer plate.
 - 2.2 For bottom plating indicate the number of the strake of plating outboard from the keel plate.
 - 2.3 For side shell plating give number of the strake of plating sheerstrake and letter as shown on shell expansion.
3. Measurements are to be taken at the forward and aft areas of all plates cross ballast/cargo tank boundaries separate measurements for the area of plating in way of each type of tank are to be recorded.
4. The single measurements recorded are to represent the average of multiple measurements.
5. The remaining corrosion addition is to be recorded with result of gauged thickness minus renewal thickness. If the result is negative, the structure in way shall be renewed, and the mark "R" is to be indicated in the right-hand column. If the result is between 0 and 0.5 mm (0 included), the structure in way shall be additional gauged, and the mark "S" is to be indicated in the right-hand column.

Z10.4 TM2-DHT(CSR) (i) Report on THICKNESS MEASUREMENT OF SHELL AND DECK PLATING
(cont'd) (one, two or three transverse sections)

Sheet 5

Ship's name.....

Class Identity No.....

Report No.....

STRENGTH DECK AND SHEERSTRAKE PLATING																									
STRAKE POSITION	FIRST TRANSVERSE SECTION AT FRAME NUMBER							SECOND TRANSVERSE SECTION AT FRAME NUMBER							THIRD TRANSVERSE SECTION AT FRAME NUMBER										
	No. or Letter	As Built Thk. mm	Vol. Thk. Add. mm	Ren. Thk. mm	Gauged Thk. mm (b)		Remaining Corr. Addition, mm (b)-(a)		No. or Letter	As Built Thk. mm	Vol. Thk. Add. mm	Ren. Thk. mm	Gauged Thk. mm (b)		Remaining Corr. Addition, mm (b)-(a)		No. or Letter	As Built Thk. mm	Vol. Thk. Add. mm	Ren. Thk. mm	Gauged Thk. mm (b)		Remaining Corr. Addition, mm (b)-(a)		
					P	S	P	S					P	S	P	S					P	S	P	S	
Stringer Plate																									
1st strake inboard																									
2nd																									
3rd																									
4th																									
5th																									
6th																									
7th																									
8th																									
9th																									
10th																									
11th																									
12th																									
13th																									
14th																									
centre strake																									
sheer strake																									
TOPSIDE TOTAL																									

Operators Signature.....

NOTES – See Reverse

Z10.4

(cont'd)

NOTES TO REPORT TM2-DHT(CSR) (i)

1. This report is to be used for recording the thickness measurement of:-

Strength deck plating and sheerstrake plating transverse sections:-

One, two or three sections within the cargo length area, comprising of the structural items (0), (1) and (2) as shown on the diagram of typical transverse sections illustrated on sheets 11 and 12 of this document.
2. The topside area comprises deck plating, stringer plate and sheerstrake (including rounded gunwales).
3. The exact frame station of measurement is to be stated.
4. The single measurements recorded are to represent the average of multiple measurements.
5. The remaining corrosion addition is to be recorded with result of gauged thickness minus renewal thickness. If the result is negative, the structure in way shall be renewed, and the mark "R" is to be indicated in the right-hand column. If the result is between 0 and 0.5 mm (0 included), the structure in way shall be additional gauged, and the mark "S" is to be indicated in the right-hand column.

Z10.4 TM2-DHT(CSR) (ii) Report on THICKNESS MEASUREMENT OF SHELL PLATING
(one, two or three transverse sections)

Sheet 6

Ship's name.....

Class Identity No.....

Report No.....

SHELL PLATING

STRAKE POSITION	FIRST TRANSVERSE SECTION AT FRAME NUMBER							SECOND TRANSVERSE SECTION AT FRAME NUMBER							THIRD TRANSVERSE SECTION AT FRAME NUMBER									
	No. or Letter	As Built Thk. mm	Vol. Thk. Add. mm	Ren. Thk. mm	Gauged Thk. mm (b)		Remaining Corr. Addition, mm (b)-(a)		No. or Letter	As Built Thk. mm	Vol. Thk. Add. mm	Ren. Thk. mm	Gauged Thk. mm (b)		Remaining Corr. Addition, mm (b)-(a)		No. or Letter	As Built Thk. mm	Vol. Thk. Add. mm	Ren. Thk. mm	Gauged Thk. mm (b)		Remaining Corr. Addition, mm (b)-(a)	
					P	S	P	S					P	S	P	S					P	S	P	S
1 st below sheer strake																								
2nd																								
3rd																								
4th																								
5th																								
6th																								
7th																								
8th																								
9th																								
10th																								
11th																								
12th																								
13th																								
14th																								
15th																								
16th																								
17th																								
18th																								
19th																								
20th																								
Keel strake																								
BOTTOM TOTAL																								

Operators Signature.....

NOTES – See Reverse

Z10.4

(cont'd)

NOTES TO REPORT TM2-DHT(CSR) (ii)

1. This report is to be used for recording the thickness measurement of:-

Shell plating transverse sections:-

One, two or three sections within the cargo length area comprising of the structural items (3), (4) and (5) and (6) as shown on the diagram of typical transverse sections illustrated on sheets 11 and 12 of this document.

2. The bottom area comprises keel, bottom and bilge plating.
3. The exact frame station of measurement is to be stated.
4. The single measurements recorded are to represent the average of multiple measurements.
5. The remaining corrosion addition is to be recorded with result of gauged thickness minus renewal thickness. If the result is negative, the structure in way shall be renewed, and the mark "R" is to be indicated in the right-hand column. If the result is between 0 and 0.5 mm (0 included), the structure in way shall be additional gauged, and the mark "S" is to be indicated in the right-hand column.

Z10.4

(cont'd)

NOTES TO REPORT TM3-DHT(CSR)

1. This report is to be used for recording the thickness measurement of:-
Longitudinal Members at transverse sections:-

One, two or three sections within the cargo length area, comprising of the appropriate structural items (10) to (29) as shown on the diagram of typical transverse sections illustrated on sheets 11 and 12 of this document.
2. The exact frame station of measurement is to be stated.
3. The single measurements recorded are to represent the average of multiple measurements.
4. The remaining corrosion addition is to be recorded with result of gauged thickness minus renewal thickness. If the result is negative, the structure in way shall be renewed, and the mark "R" is to be indicated in the right-hand column. If the result is between 0 and 0.5 mm (0 included), the structure in way shall be additional gauged, and the mark "S" is to be indicated in the right-hand column.

Z10.4 TM4-DHT(CSR)
(cont'd)

**Report on THICKNESS MEASUREMENT OF TRANSVERSE STRUCTURAL MEMBERS
In the cargo oil and water ballast tanks within the cargo tank length**

Sheet 8

Ship's name.....

Class Identity No.....

Report No.....

TANK DESCRIPTION:									
LOCATION OF STRUCTURE									
STRUCTURAL MEMBER	ITEM	As Built Thickness mm	Voluntary Thickness Addition mm	Renewal Thickness mm (a)	Gauged Thickness mm (b)		Remaining Corr. Addition mm (b)-(a)		
					P	S	P	S	S

Operators Signature.....

NOTES – See Reverse

Z10.4**NOTES TO REPORT TM4-DHT(CSR)**

(cont'd)

1. This report is to be used for recording the thickness measurement of:-

Transverse structural members, comprising of the appropriate structural items (30) to (36) as shown on diagram of typical transverse section, illustrated on sheets 11 and 12 of this document.
2. Guidance for areas if measurement is indicated on the diagrams shown on sheet 14 and 15 of this document.
3. The single measurements recorded are to represent the average of multiple measurements.
4. The remaining corrosion addition is to be recorded with result of gauged thickness minus renewal thickness. If the result is negative, the structure in way shall be renewed, and the mark "R" is to be indicated in the right-hand column. If the result is between 0 and 0.5 mm (0 included), the structure in way shall be additional gauged, and the mark "S" is to be indicated in the right-hand column.

Z10.4

(cont'd)

NOTES TO REPORT TM5-DHT(CSR)

1. This report is to be used for recording the thickness measurement of:-
W.T./O.T. transverse bulkheads.
2. Guidance for areas of measurement is indicated on the diagrams shown on sheet 14 of this document.
3. The single measurements recorded are to represent the average of multiple measurements.
4. The remaining corrosion addition is to be recorded with result of gauged thickness minus renewal thickness. If the result is negative, the structure in way shall be renewed, and the mark "R" is to be indicated in the right-hand column. If the result is between 0 and 0.5 mm (0 included), the structure in way shall be additional gauged, and the mark "S" is to be indicated in the right-hand column.

Z10.4 TM6-DHT(CSR)
(cont'd)

Report on THICKNESS MEASUREMENT OF MISCELLANEOUS STRUCTURAL MEMBERS

Sheet 10

Ship's name.....

Class Identity No.....

Report No.....

STRUCTURAL MEMBER:						SKETCH							
LOCATION OF STRUCTURE:													
Description	As Built Thk. mm	Voluntary Thickness Addition mm	Renewal Thickness mm (a)	Gauged Thickness mm (b)						Remaining Corr. Addition mm (b)-(a)			
				P	S					P	S	P	S

Operators Signature.....

NOTES – See Reverse

Z10.4

(cont'd)

NOTES TO REPORT TM6-DHT(CSR)

1. This report is to be used for recording the thickness measurement of:-
Miscellaneous structural members.
2. The single measurements recorded are to represent the average of multiple measurements.
3. The remaining corrosion addition is to be recorded with result of gauged thickness minus renewal thickness. If the result is negative, the structure in way shall be renewed, and the mark "R" is to be indicated in the right-hand column. If the result is between 0 and 0.5 mm (0 included), the structure in way shall be additional gauged, and the mark "S" is to be indicated in the right-hand column.

Z10.4
(cont'd)

Thickness Measurement - Double Hull Oil Tankers

Typical transverse section of a double hull oil tanker up to 150,000 dwt with indication of longitudinal and transverse members

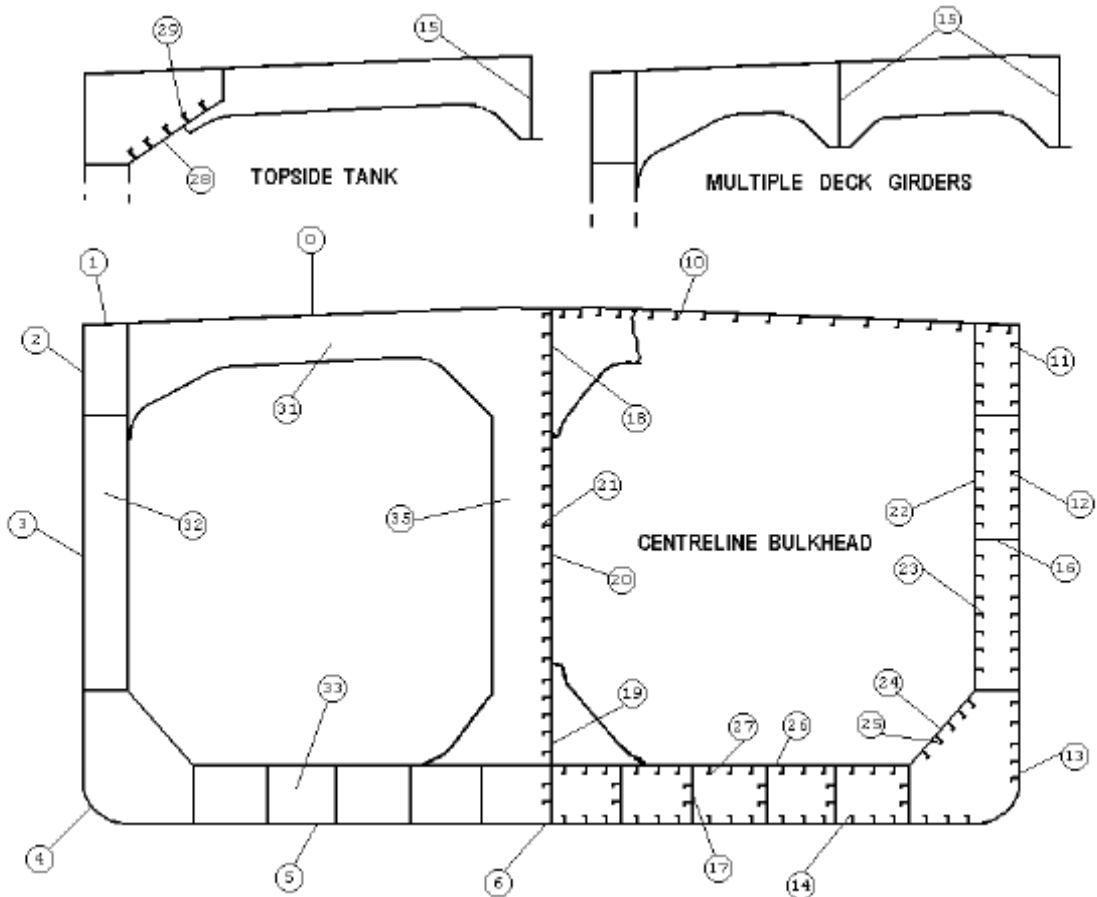

Report on TM2-DHT(CSR) (i) & (ii)	
0.	Strength deck plating
1.	Stringer plate
2.	Sheerstrake
3.	Side shell plating
4.	Bilge plating
5.	Bottom shell plating
6.	Keel plate

Report on TM3-DHT(CSR)			
10.	Deck longitudinals	20.	Longitudinal bulkhead plating (remainder)
11.	Sheerstrake longitudinals	21.	Longitudinal bulkhead longitudinals
12.	Side shell longitudinals	22.	Inner side plating
13.	Bilge longitudinals	23.	Inner side longitudinal
14.	Bottom longitudinals	24.	Hopper plating
15.	Deck girders	25.	Hopper longitudinal
16.	Horizontal girders in wing ballast tanks	26.	Inner bottom plating
17.	Bottom girders	27.	Inner bottom longitudinals
18.	Longitudinal bulkhead top strake	28.	Topside tank plating
19.	Longitudinal bulkhead bottom strake	29.	Topside tank longitudinals

Report on TM4-DHT(CSR)	
30.	Deck transverse - centre tank
31.	Deck transverse - wing tank
32.	Vertical web in wing ballast tank
33.	Double bottom floor - wing tank
34.	Double bottom floor - centre tank
35.	Longitudinal bulkhead vertical web
36.	Cross ties

Z10.4
(cont'd)

Thickness Measurement - Double Hull Oil Tankers

Typical transverse section of a double hull oil tanker above 150,000 dwt with indication of longitudinal and transverse members

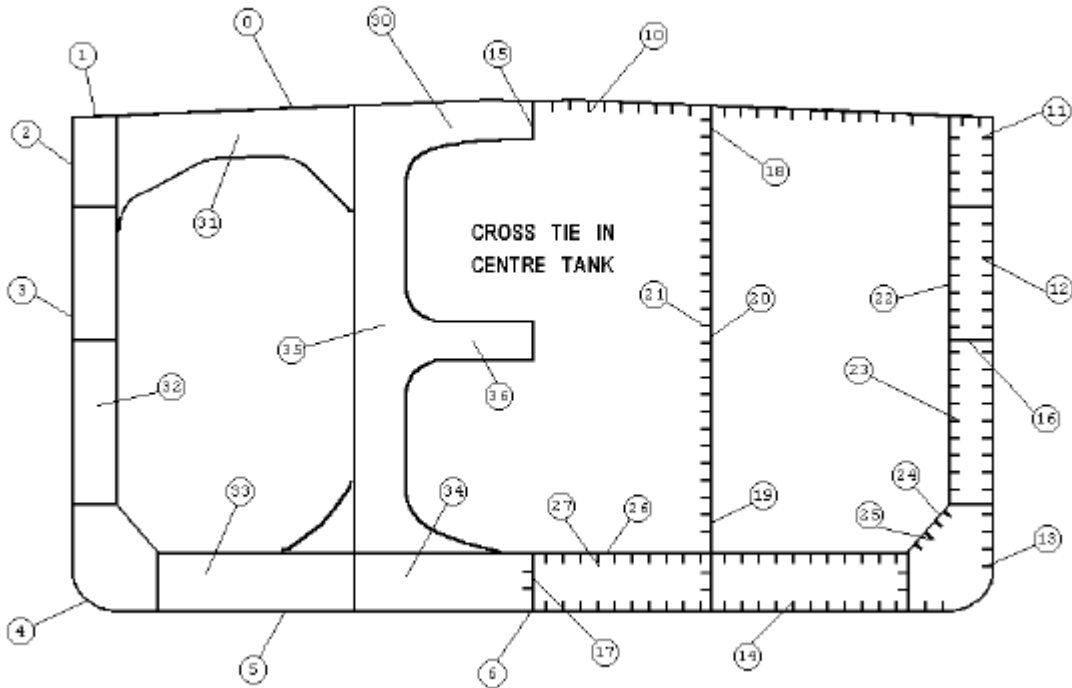

Report on TM2-DHT(CSR) (i) & (ii)	
0.	Strength deck plating
1.	Stringer plate
2.	Sheerstrake
3.	Side shell plating
4.	Bilge plating
5.	Bottom shell plating
6.	Keel plate

Report on TM3-DHT(CSR)			
10.	Deck longitudinals	20.	Longitudinal bulkhead plating (remainder)
11.	Sheerstrake longitudinals	21.	Longitudinal bulkhead longitudinals
12.	Side shell longitudinals	22.	Inner side plating
13.	Bilge longitudinals	23.	Inner side longitudinal
14.	Bottom longitudinals	24.	Hopper plating
15.	Deck girders	25.	Hopper longitudinal
16.	Horizontal girders in wing ballast tanks	26.	Inner bottom plating
17.	Bottom girders	27.	Inner bottom longitudinals
18.	Longitudinal bulkhead top strake	28.	Topside tank plating
19.	Longitudinal bulkhead bottom strake	29.	Topside tank longitudinals

Report on TM4-DHT(CSR)	
30.	Deck transverse - centre tank
31.	Deck transverse - wing tank
32.	Vertical web in wing ballast tank
33.	Double bottom floor - wing tank
34.	Double bottom floor - centre tank
35.	Longitudinal bulkhead vertical web
36.	Cross ties

Z10.4
(cont'd)

Thickness Measurement - Double Hull Oil Tankers

Transverse section outline

The diagram may be used for those ships where the diagrams on sheet 11 and 12 are not suitable

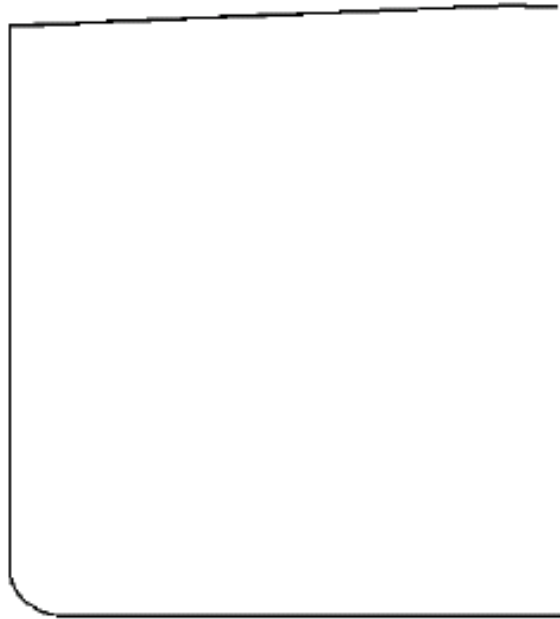

Report on TM2-DHT(CSR) (i) & (ii)	
0.	Strength deck plating
1.	Stringer plate
2.	Sheerstrake
3.	Side shell plating
4.	Bilge plating
5.	Bottom shell plating
6.	Keel plate

Report on TM3-DHT(CSR)			
10.	Deck longitudinals	20.	Longitudinal bulkhead plating (remainder)
11.	Sheerstrake longitudinals	21.	Longitudinal bulkhead longitudinals
12.	Side shell longitudinals	22.	Inner side plating
13.	Bilge longitudinals	23.	Inner side longitudinal
14.	Bottom longitudinals	24.	Hopper plating
15.	Deck girders	25.	Hopper longitudinal
16.	Horizontal girders in wing ballast tanks	26.	Inner bottom plating
17.	Bottom girders	27.	Inner bottom longitudinals
18.	Longitudinal bulkhead top strake	28.	Topside tank plating
19.	Longitudinal bulkhead bottom strake	29.	Topside tank longitudinals

Report on TM4-DHT(CSR)	
30.	Deck transverse - centre tank
31.	Deck transverse - wing tank
32.	Vertical web in wing ballast tank
33.	Double bottom floor - wing tank
34.	Double bottom floor - centre tank
35.	Longitudinal bulkhead vertical web
36.	Cross ties

Z10.4

Close-up Survey and Thickness Measurement Areas

(cont'd)

Areas subject to close-up survey and thickness measurements - areas (1) to (5) as defined in Table I of UR Z10.4 - Thickness to be reported on TM3-DHT(CSR), TM4-DHT(CSR) and TM5-DHT(CSR) as appropriate.

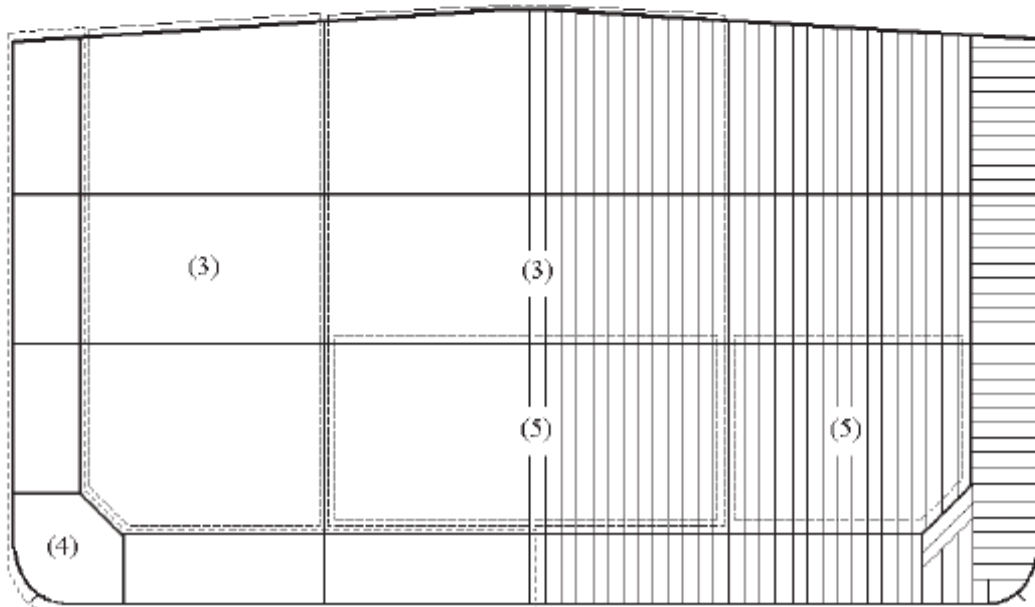
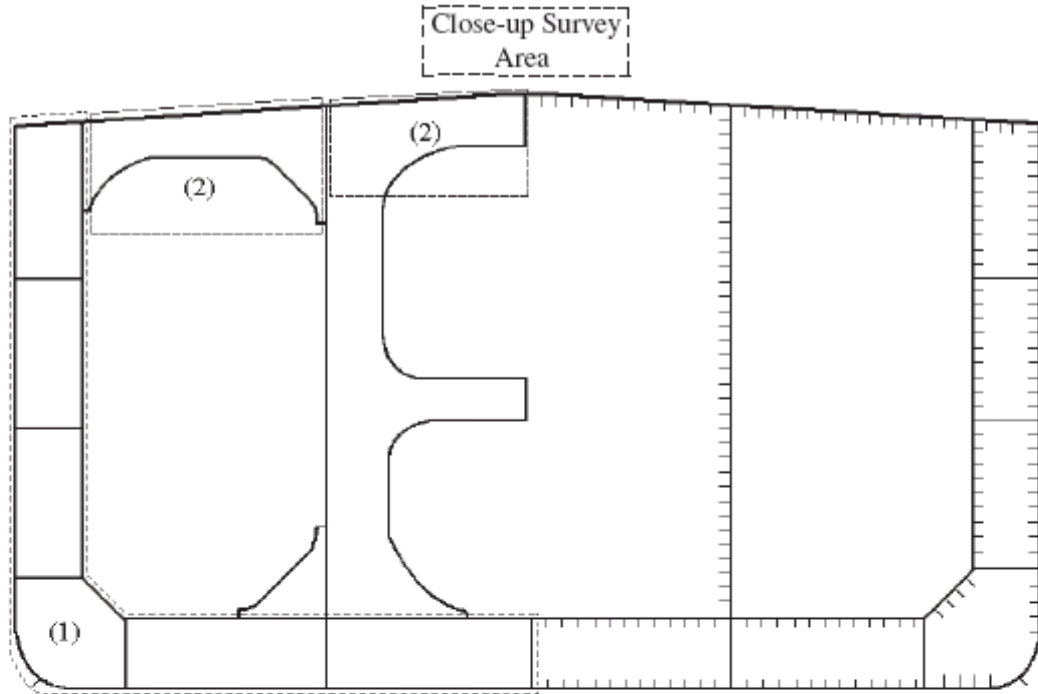

Z10.4**Close-up Survey and Thickness Measurement Areas**

Sheet 15

(cont'd)

Areas subject to close-up survey and thickness measurements - areas (6) to (7) as defined in Table I of UR Z10.4 - Thickness to be reported on TM3-DHT(CSR), TM4-DHT(CSR) as appropriate.

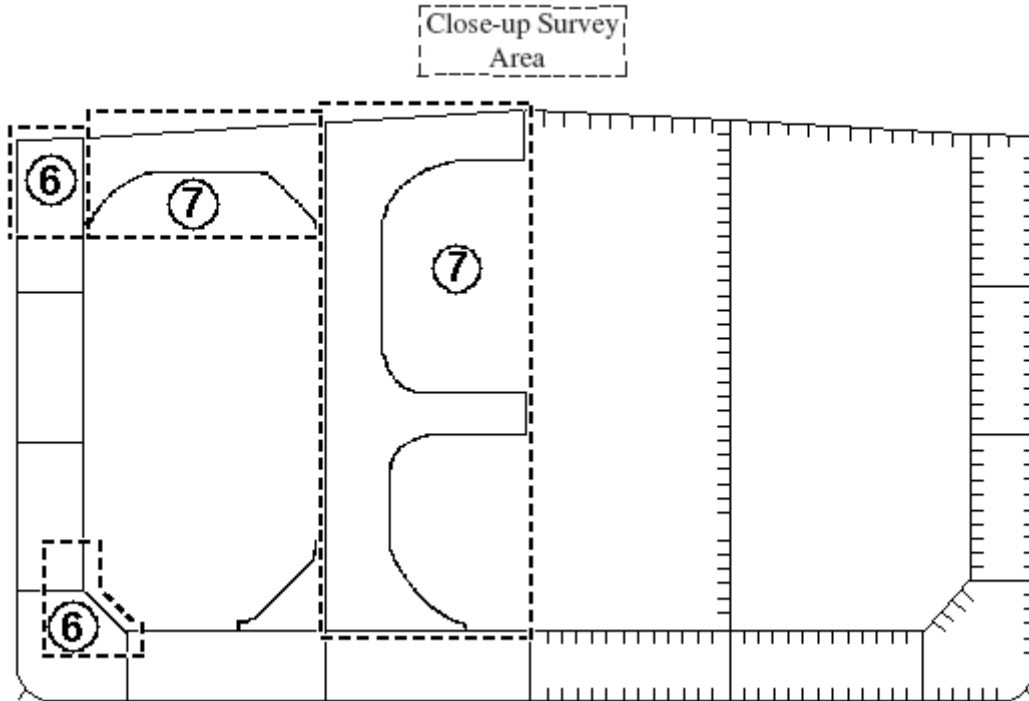
End of
Annex II

Z10.4
(cont'd)

ANNEX III

CRITERIA FOR LONGITUDINAL STRENGTH OF HULL GIRDER FOR OIL TANKERS

Z10.4

(cont'd)

ANNEX III**CRITERIA FOR LONGITUDINAL STRENGTH OF HULL GIRDER FOR OIL TANKERS****1 General**

1.1 These criteria is to be used for the evaluation of longitudinal strength of the ship's hull girder as required by section 8.1.1.1.

1.2 In order that ship's longitudinal strength to be evaluated can be recognized as valid, fillet welding between longitudinal internal members and hull envelopes is to be in sound condition so as to keep integrity of longitudinal internal members with hull envelopes.

2 Evaluation of longitudinal strength

On oil tankers of 130 m in length and upwards and of over 10 years of age, the longitudinal strength of the ship's hull girder is to be evaluated in compliance with the requirements of this annex on the basis of the thickness measured, renewed or reinforced, as appropriate, during the special survey.

The condition of the hull girder for longitudinal strength evaluation should be determined in accordance with the methods specified in appendix 3.

2.1 Calculation of transverse sectional areas of deck and bottom flanges of hull girder

2.1.1 The transverse sectional areas of deck flange (deck plating and deck longitudinals) and bottom flange (bottom shell plating and bottom longitudinals) of the ship's hull girder is to be calculated by using the thickness measured, renewed or reinforced, as appropriate, during the special survey.

2.1.2 If the diminution of sectional areas of either deck or bottom flange exceeds 10% of their respective as-built area (i.e. original sectional area when the ship was built), either one of the following measures is to be taken:

- .1 to renew or reinforce the deck or bottom flanges so that the actual sectional area is not less than 90% of the as-built area; or
- .2 to calculate the actual section moduli (Z_{act}) of transverse section of the ship's hull girder by applying the calculation method specified in appendix 1, by using the thickness measured, renewed or reinforced, as appropriate, during the special survey.

2.2 Requirements for transverse section modulus of hull girder

2.2.1 The actual section moduli of transverse section of the ship's hull girder calculated in accordance with the foregoing paragraph 2.1.2.2 is to satisfy either of the following provisions, as applicable:

- .1 for ships constructed on or after 1 July 2002, the actual section moduli (Z_{act}) of the transverse section of the ship's hull girder calculated in accordance with the requirements of the foregoing paragraph 2.1.2.2 should be not less than the diminution limits determined by the Classification Society*; or

Z10.4
(cont'd)

- .2 for ships constructed before 1 July 2002, the actual section moduli (Z_{act}) of the transverse section of the ship's hull girder calculated in accordance with the requirements of the foregoing paragraph 2.1.2.2 is to meet the criteria for minimum section modulus for ships in service required by the Classification Society, provided that in no case Z_{act} is to be less than the diminution limit of the minimum section modulus (Z_{mc}) as specified in appendix 2.

-
- * The actual transverse section modulus of the hull girder of oil tankers calculated under paragraph 2.2.1.1 of Annex III to UR Z10.4 is not to be less than 90% of the required section modulus for new buildings specified in IACS Unified Requirements S7* or S11, whichever is the greater.

* $C = 1.0 c_n$ is to be used for the purpose of this calculation.

Z10.4

(cont'd)

APPENDIX 1**CALCULATION CRITERIA OF SECTION MODULI OF MIDSHIP SECTION OF HULL GIRDER**

- 1 When calculating the transverse section modulus of the ship's hull girder, the sectional area of all continuous longitudinal strength members is to be taken into account.
- 2 Large openings, i.e. openings exceeding 2.5m in length or 1.2m in breadth and scallops, where scallop welding is applied, are always to be deducted from the sectional areas used in the section modulus calculation.
- 3 Smaller openings (manholes, lightening holes, single scallops in way of seams, etc.) need not be deducted provided that the sum of their breadths or shadow area breadths in one transverse section does not reduce the section modulus at deck or bottom by more than 3% and provided that the height of lightening holes, draining holes and single scallops in longitudinals or longitudinal girders does not exceed 25% of the web depth, for scallops maximum 75mm.
- 4 A deduction-free sum of smaller opening breadths in one transverse section in the bottom or deck area of $0.06(\sum B - b)$ (where B = breadth of ship, $\sum b$ = total breadth of large openings) may be considered equivalent to the above reduction in sectional modulus.
- 5 The shadow area will be obtained by drawing two tangent lines with an opening angle of 30° .
- 6 The deck modulus is related to the moulded deck line at side.
- 7 The bottom modulus is related to the base line.
- 8 Continuous trunks and longitudinal hatch coamings are to be included in the longitudinal sectional area provided they are effectively supported by longitudinal bulkheads or deep girders. The deck modulus is then to be calculated by dividing the moment of inertia by the following distance, provided this is greater than the distance to the deck line at side:

$$y_t = y \left(0.9 + 0.2 \frac{x}{B} \right)$$

where:

- y = distance from neutral axis to top of continuous strength member,
 x = distance from top of continuous strength member to centreline of the ship.
 x and y to be measured to the point giving the largest value of y_t .

- 9 Longitudinal girders between multi-hatchways will be considered by special calculations.

Z10.4

(cont'd)

APPENDIX 2**DIMINUTION LIMIT OF MINIMUM LONGITUDINAL STRENGTH
OF SHIPS IN SERVICE**

1 The diminution limit of the minimum section modulus (Z_{mc}) of oil tankers in service is given by the following formula:

$$Z_{mc} = cL^2B(C_b + 0.7)k \quad (\text{cm}^3)$$

where

L = Length of ships. L is the distance, in metres, on the summer load waterline from the fore side of stem to the after side of the rudder post, or the centre of the rudder stock if there is no rudder post. L is not to be less than 96%, and need not be greater than 97%, of the extreme length on the summer load waterline. In ships with unusual stern and bow arrangement the length L may be specially considered.

B = Greatest moulded breadth in metres.

C_b = Moulded block coefficient at draught d corresponding to summer load waterline, based on L and B . C_b is not to be taken less than 0.60.

$$C_b = \frac{\text{moulded displacement (m}^3\text{) at draught } d}{L \times B \times d}$$

$$c = 0.9 c_n$$

$$c_n = 10.75 - \left(\frac{300 - L}{100} \right)^{1.5} \quad \text{for } 130 \text{ m} \leq L \leq 300 \text{ m}$$

$$c_n = 10.75 \quad \text{for } 300 \text{ m} < L < 350 \text{ m}$$

$$c_n = 10.75 - \left(\frac{L - 350}{150} \right)^{1.5} \quad \text{for } 350 \text{ m} \leq L \leq 500 \text{ m}$$

k = material factor, e.g.

$k = 1.0$ for mild steel with yield stress of 235N/mm² and over;

$k = 0.78$ for high tensile steel with yield stress of 315N/mm² and over;

$k = 0.72$ for high tensile steel with yield stress of 355N/mm² and over.

Z10.4
(cont'd)

2 Scantlings of all continuous longitudinal members of the ship's hull girder based on the section modulus requirement in 1 are to be maintained within 0.4L amidships. However, in special cases, based on consideration of type of ship, hull form and loading conditions, the scantlings may be gradually reduced towards the end of 0.4L part, bearing in mind the desire not to inhibit the ship's loading flexibility.

3 However, the above standard may not be applicable to ships of unusual type or design, e.g. for ships of unusual main proportions and/or weight distributions.

Z10.4

(cont'd)

APPENDIX 3**SAMPLING METHOD OF THICKNESS MEASUREMENTS
FOR LONGITUDINAL STRENGTH EVALUATION
AND REPAIR METHODS****1 Extent of longitudinal strength evaluation**

Longitudinal strength should be evaluated within 0.4L amidships for the extent of the hull girder length that contains tanks therein and within 0.5L amidships for adjacent tanks which may extend beyond 0.4L amidships, where tanks means ballast tanks and cargo tanks.

2 Sampling method of thickness measurement

2.1 Pursuant to the requirements of section 2.4 of Z10.4, transverse sections should be chosen such that thickness measurements can be taken for as many different tanks in corrosive environments as possible, e.g. ballast tanks sharing a common plane boundary with cargo tanks fitted with heating coils, other ballast tanks, cargo tanks permitted to be filled with sea water and other cargo tanks. Ballast tanks sharing a common plane boundary with cargo tanks fitted with heating coils and cargo tanks permitted to be filled with sea water should be selected where present.

2.2 The minimum number of transverse sections to be sampled should be in accordance with Table II of Z10.4. The transverse sections should be located where the largest thickness reductions are suspected to occur or are revealed from deck and bottom plating measurements prescribed in 2.3 and should be clear of areas which have been locally renewed or reinforced.

2.3 At least two points should be measured on each deck plate and/or bottom shell plate required to be measured within the cargo area in accordance with the requirements of Table II of Z10.4.

2.4 Within 0.1D (where D is the ship's moulded depth) of the deck and bottom at each transverse section to be measured in accordance with the requirements of Table II of Z10.4, every longitudinal and girder should be measured on the web and face plate, and every plate should be measured at one point between longitudinals.

2.5 For longitudinal members other than those specified in 2.4 to be measured at each transverse section in accordance with the requirements of Table II of Z10.4, every longitudinal and girder should be measured on the web and face plate, and every plate should be measured at least in one point per strake.

2.6 The thickness of each component should be determined by averaging all of the measurements taken in way of the transverse section on each component.

3 Additional measurements where the longitudinal strength is deficient

3.1 Where one or more of the transverse sections are found to be deficient in respect of the longitudinal strength requirements given in this annex, the number of transverse sections for thickness measurement should be increased such that each tank within the 0.5L amidships region has been sampled. Tank spaces that are partially within, but extend beyond, the 0.5L region, should be sampled.

Z10.4
(cont'd)

3.2 Additional thickness measurements should also be performed on one transverse section forward and one aft of each repaired area to the extent necessary to ensure that the areas bordering the repaired section also comply with the requirements of Z10.4.

4 Effective repair methods

4.1 The extent of renewal or reinforcement carried out to comply with this annex should be in accordance with 4.2.

4.2 The minimum continuous length of a renewed or reinforced structural member should be not less than twice the spacing of the primary members in way. In addition, the thickness diminution in way of the butt joint of each joining member forward and aft of the replaced member (plates, stiffeners, girder webs and flanges, etc.) should not be within the substantial corrosion range (75% of the allowable diminution associated with each particular member). Where differences in thickness at the butt joint exceed 15% of the lower thickness, a transition taper should be provided.

4.3 Alternative repair methods involving the fitting of straps or structural member modification should be subject to special consideration. In considering the fitting of straps, it should be limited to the following conditions:

- .1 to restore and/or increase longitudinal strength;
- .2 the thickness diminution of the deck or bottom plating to be reinforced should not be within the substantial corrosion range (75% of the allowable diminution associated with the deck plating);
- .3 the alignment and arrangement, including the termination of the straps, is in accordance with a standard recognized by the Classification Society;
- .4 the straps are continuous over the entire 0.5L amidships length; and
- .5 continuous fillet welding and full penetration welds are used at butt welding and, depending on the width of the strap, slot welds. The welding procedures applied should be acceptable to the Classification Society.

4.4 The existing structure adjacent to replacement areas and in conjunction with the fitted straps, etc. should be capable of withstanding the applied loads, taking into account the buckling resistance and the condition of welds between the longitudinal members and hull envelope plating.

End of Annex III

Z10.4
(cont'd)

ANNEX IV

Z10.4

(cont'd)

ANNEX IVA**SURVEY PROGRAMME**

Basic information and particulars

Name of ship:

IMO number:

Flag State:

Port of registry:

Gross tonnage:

Deadweight (metric tonnes):

Length between perpendiculars (m):

Shipbuilder:

Hull number:

Classification Society:

Class ID:

Date of build of the ship:

Owner:

Thickness measurement company:

Z10.4

Preamble

(cont'd)

1.1 Scope

1.1.1 The present survey programme covers the minimum extent of overall surveys, close-up surveys, thickness measurements and pressure testing within the cargo area, cargo tanks, ballast tanks, including fore and aft peak tanks, required by UR Z10.4.

1.1.2 The arrangements and safety aspects of the survey are to be acceptable to the attending surveyor(s).

1.2 Documentation

All documents used in the development of the survey programme are to be available onboard during the survey as required by section 6.

2 Arrangement of tanks and spaces

This section of the survey programme is to provide information (either in the form of plans or text) on the arrangement of tanks and spaces that fall within the scope of the survey.

3 List of tanks and spaces with information on their use, extent of coatings and corrosion protection system

This section of the survey programme is to indicate any changes relating to (and is to update) the information on the use of the tanks of the ship, the extent of coatings and the corrosion protective system provided in the Survey Planning Questionnaire.

4 Conditions for survey

This section of the survey programme is to provide information on the conditions for survey, e.g. information regarding cargo hold and tank cleaning, gas freeing, ventilation, lighting, etc.

5 Provisions and method of access to structures

This section of the survey programme is to indicate any changes relating to (and is to update) the information on the provisions and methods of access to structures provided in the Survey Planning Questionnaire.

6 List of equipment for survey

This section of the survey programme is to identify and list the equipment that will be made available for carrying out the survey and the required thickness measurements.

7 Survey requirements

7.1 Overall survey

This section of the survey programme is to identify and list the spaces that are to undergo an overall survey for the ship in accordance with 2.3.1.

Z10.4**7.2 Close-up survey**

(cont'd)

This section of the survey programme is to identify and list the hull structures that are to undergo a close-up survey for the ship in accordance with 2.3.2.

8 Identification of tanks for tank testing

This section of the survey programme is to identify and list the tanks that are to undergo tank testing for the ship in accordance with 2.5.

9 Identification of areas and sections for thickness measurements

This section of the survey programme is to identify and list the areas and sections where thickness measurements are to be taken in accordance with 2.4.1.

10 Minimum thickness of hull structures

This section of the survey programme is to specify the minimum thickness for hull structures of this ship that are subject to UR Z10.4 (indicate either (a) or preferably (b), if such information is available):

- (a) Determined from the attached wastage allowance table and the original thickness to the hull structure plans of the ship;
- (b) Given in the following table(s):

Area or location	Original as-built thickness (mm)	Minimum thickness (mm)	Substantial corrosion thickness (mm)
Deck			
Plating			
Longitudinals			
Longitudinal girders			
Bottom			
Plating			
Longitudinals			
Longitudinal girders			
Ship side			
Plating			
Longitudinals			
Longitudinal girders			
Longitudinal bulkhead			
Plating			
Longitudinals			
Longitudinal girders			
Inner bottom			
Plating			
Longitudinals			
Longitudinal girders			
Transverse bulkheads			
Plating			
Stiffeners			

Z10.4
(cont'd)

Transverse web frames, floors and stringers			
Plating			
Flanges			
Stiffeners			
Cross ties			
Flanges			
Webs			

Note: The wastage allowance tables are to be attached to the survey programme.

For vessels built under IACS Common Structural Rules, the renewal thickness of the hull structure elements is indicated in the appropriate drawings.

11 Thickness measurement company

This section of the survey programme is to identify changes, if any, relating to the information on the thickness measurement company provided in the Survey Planning Questionnaire.

12 Damage experience related to the ship

This section of the survey programme is to, using the tables provided below, provide details of the hull damages for at least the last three years in way of the cargo and ballast tanks and void spaces within the cargo area. These damages are subject to survey.

Hull damages sorted by location for the ship

Tank or space number or area	Possible cause, if known	Description of the damages	Location	Repair	Date of repair

Z10.4 Appendices

(cont'd)

Appendix 1 - List of plans

Paragraph 5.1.3.2 requires that main structural plans of cargo and ballast tanks (scantling drawings), including information regarding use of high tensile steel (HTS), to be available. This appendix of the survey programme is to identify and list the main structural plans which form part of the survey programme.

Appendix 2 - Survey Planning Questionnaire

The Survey Planning Questionnaire (annex IVB), which has been submitted by the owner, is to be appended to the survey programme.

Appendix 3 - Other documentation

This part of the survey programme is to identify and list any other documentation that forms part of the Plan.

Prepared by the owner in co-operation with the Classification Society for compliance with 5.1.3.

Date:..... (name and signature of authorized owner's representative)

Date:..... (name and signature of authorized representative of the Classification Society)

Z10.4

(cont'd)

ANNEX IVB**SURVEY PLANNING QUESTIONNAIRE**

The following information will enable the owner in co-operation with the Classification Society to develop a survey programme complying with the requirements of UR Z10.4. It is essential that the owner provides, when completing the present questionnaire, up-to-date information. The present questionnaire, when completed, is to provide all information and material required by UR Z10.4.

Particulars

Ship's name:

IMO number:

Flag State:

Port of registry:

Owner:

Classification Society:

Class ID:

Gross tonnage:

Deadweight (metric tonnes):

Date of build:

Information on access provision for close-up surveys and thickness measurement:

The owner is to indicate, in the table below, the means of access to the structures subject to close-up survey and thickness measurement. A close-up survey is an examination where the details of structural components are within the close visual inspection range of the attending surveyor, i.e. normally within reach of hand.

Tank No.	Structure	C(Cargo)/ B(Ballast)	Permanent Means of Access	Temporary staging	Rafts	Ladders	Direct access	Other means (please specify)
F.P.	Fore Peak							
A.P.	Aft Peak							
Wing Tanks	Under deck							
	Side shell							
	Bottom transverse							
	Longitudinal							
	Transverse							
Centre Tanks	Underdeck							
	Bottom transverse							
	Transverse							

Z10.4

(cont'd)

History of cargo with H₂S content or heated cargo for the last 3 years together with indication as to whether cargo was heated and, where available, Marine Safety Data Sheets (MSDS)*

* Refer to resolution MSC. 150(77) on Recommendation for material safety data sheets for MARPOL Annex I cargoes and marine fuel oils.

Owner's inspections

Using a format similar to that of the table below (which is given as an example), the owner is to provide details of the results of their inspections for the last 3 years on all cargo and ballast tanks and void spaces within the cargo area, including peak tanks.

Tank No.	Corrosion protection (1)	Coating extent (2)	Coating condition (3)	Structural deterioration (4)	Tank damage history (5)
Cargo centre tanks					
Cargo wing tanks					
Slop					

Z10.4

(cont'd)

Tank No.	Corrosion protection (1)	Coating extent (2)	Coating condition (3)	Structural deterioration (4)	Tank damage history (5)
Ballast tanks					
Aft peak					
Fore peak					
Miscellaneous spaces					

Note: Indicate tanks which are used for oil/ballast.

- 1) HC=hard coating; SC=soft coating;
SH=semi-hard coating; NP=no protection
- 2) U=upper part; M=middle part;
L=lower part; C=complete
- 3) G=good; F=fair; P=poor;
RC=recoated (during the last 3 years)
- 4) N=no findings recorded; Y=findings recorded,
description of findings is to be attached to the questionnaire
- 5) DR=damage & repair; L=leakages;
CV=conversion
(description is to be attached to this questionnaire)

Name of owner's representative:

Signature:

Date:

Z10.4

(cont'd)

ANNEX IVC**OWNER'S INSPECTION REPORT****Structural condition**

Ship's name:

For tank No:

Grade of steel:

deck:

side:

bottom:

longitudinal bulkhead:

Elements	Cracks	Buckles	Corrosion	Coating condition	Pitting	Modification/ repair	Other
Deck							
Bottom							
Side							
Longitudinal bulkhead							
Transverse bulkhead							

Repairs carried out due to:

Thickness measurements carried out

(dates):

Results in general:

Overdue surveys:

Outstanding conditions of class:

Comments:

Date of inspection:

Inspected by:

Signature:

Annex IV end Document end
