



## **BULK CARRIERS**

# **Guidance and Information on Bulk Cargo Loading and Discharging to Reduce the Likelihood of Over-stressing the Hull Structure**

Rev.1 July 2018

**© IACS – the International Association of Classification Societies, 1997 and International Association of Classification Societies Limited 2018**

All rights reserved.

Except as permitted under current English legislation no part of this work may be photocopied, stored in a retrieval system, published, performed in public, adapted, broadcast, transmitted, recorded or reproduced in any form or by any means, without prior permission of the copyright owner.

Where IACS has granted written permission for any part of this publication to be quoted such quotation must include acknowledgement to IACS.

Enquiries should be addressed to;

~~The Permanent Secretary,  
International Association of Classification Societies,  
5 Old Queen Street,  
London,  
SW1H 9JA~~

Telephone: ~~+(44) 171 976 0660~~  
Telefax ~~+(44) 171 976 0440~~  
Internet ~~permsec@iacs.org.uk~~

The Secretary General,  
International Association of Classification Societies Ltd,  
36 Broadway, London, SW1H 0BH

Telephone: +(44)(0) 20 7976 0660  
Telefax: +(44)(0) 20 7808 1100  
Internet: permsec@iacs.org.uk

## **ACKNOWLEDGEMENT**

IACS acknowledges the contributions ~~make~~ made by a variety of marine industry sources in the preparation of this text and specifically acknowledges the kind contribution of the International Bulk Journal for the provision of a photograph for the front cover of this edition.

## **DISCLAIMER**

The IACS members, their affiliates and subsidiaries and their respective officers, employees or agents (on behalf of whom this disclaimer is given) are, individually and collectively, referred to in this disclaimer as the "IACS Members". The IACS Members assume no responsibility and shall not be liable whether in contract or in tort (including negligence) or otherwise to any person for any liability, or any direct, indirect or consequential loss, damage or expense caused by or arising from the use and/or availability of the information expressly or impliedly given in this document, howsoever provided, including for any inaccuracy or omission in it. For the avoidance of any doubt, this document and the material contained in it are provided as information only and not as advice to be relied upon by any person. Any dispute concerning the provision of this document or the information contained in it is subject to the exclusive jurisdiction of the English courts and will be governed by English law.

## **TERMS AND CONDITIONS**

~~"The International Association of Classification Societies (IACS), its Member Societies and their officers, members, employees, and agents (on behalf of whom this notice is issued) shall be under no liability or responsibility in negligence or otherwise howsoever to any person in respect of any information or advice expressly or impliedly given in this document, or in respect of any inaccuracy herein or omission herefrom or in respect of any act or omission which has caused or contributed to this document being issued with the information or advice it contains (if any).~~

~~Without derogating from the generality of the foregoing, neither IACS nor its Member Societies and their officers, members, employees or agents shall be liable in negligence or otherwise howsoever for any indirect or consequential loss to any person caused by or rising from any information, advice, inaccuracy or omission being given or contained herein or any act or omission causing or contributing to any such information, advice, inaccuracy, or omission being given or contained herein."~~

## EXECUTIVE SUMMARY

This publication is intended to provide the shipping community with guidance and information on the loading and discharging of bulk carriers to remain within the limitations as specified by the ~~classification society~~ Classification Society to reduce the likelihood of over-stressing the ship's structure.

The loads that affect the ship's structure are generally discussed with special reference to the structural strength limitations imposed by the ship's ~~classification society~~ Classification Society.

The process of planning and controlling cargo operations is addressed with special reference to the derivation of the loading and unloading plans and the requirements for ship/shore communication.

A review of the potential problems that could be encountered during cargo operations is presented. Guidance is given on the measures that should be taken to monitor and control cargo and ballasting operations in order to reduce the possibility of over-stressing the ship's structure.

---

# No. 46 Guidance and Information on Bulk Cargo Loading and Discharging to Reduce the Likelihood of Overstressing the Hull Structure

(1996)  
(Rev.1  
July 2018)

- 1 Introduction**
  - 1.1 Factors Contributing to Hull Structural Failure
  - 1.2 Actions Taken by IACS
  - 1.3 Aims of This Publication
  
- 2 Loads and Hull Structure**
  - 2.1 Typical Bulk Carrier Structural Configuration
  - 2.2 Design Limitations
    - 2.2.1 General
    - 2.2.2 Hull Girder Shear Forces and Bending Moments
    - 2.2.3 Local Strength of Transverse Bulkhead, Double Bottom and Cross Deck Structure
  - 2.3 Cargo Distributions Along Ship's Length
    - 2.3.1 General
    - 2.3.2 Homogeneous Hold Loading Conditions (Fully loaded)
    - 2.3.3 Alternate Hold Loading Conditions (Fully loaded)
    - 2.3.4 Block Hold Loading and Part Loaded Conditions
    - 2.3.5 The change of weight distribution arising from fuel and ballast water
  
- 3 Onboard Loading Guidance Information**
  - 3.1 Loading Manual
  - 3.2 Loading Instrument
  
- 4 Planning and Control of Cargo Loading and Unloading Operations**
  - 4.1 Preparation for Cargo operations
    - 4.1.1 Cargo and Port Information
    - 4.1.2 Devising a Cargo Stowage Plan and Loading/Unloading Plan
    - 4.1.3 Ship/Shore Communication Prior to the Commencement of Cargo Operations
    - 4.1.4 Before Commencing Cargo Operations
  - 4.2 Monitoring and Controlling Cargo Operations
    - 4.2.1 Monitoring of Stevedoring Operation
    - 4.2.2 Monitoring the Ship's Loaded Condition
    - 4.2.3 Hull Damage Caused by Cargo Operations
  
- 5 Potential Problems**
  - 5.1 Deviation from the Limitations Given in the Approved Loading Manual
  - 5.2 Loading Cargo in a Shallow Draught Condition
  - 5.3 High Loading Rates
  - 5.4 Asymmetric Cargo and Ballast Distribution
  - 5.5 Lack of Effective Ship/Shore Communication
  - 5.6 Exceeding the Assigned Load Line Marks
  - 5.7 Partially Filled Ballast Holds or Tanks
  - 5.8 Inadequate Cargo Weight Measurement During Loading
  - 5.9 Structural Damage During Loading/Unloading
  
- 6 Ballast Exchange at Sea**

**No.  
46**  
(cont)**1. Introduction****1.1 Factors Contributing to Hull Structural Failure**

As a result of concern regarding the high casualty rate of single side skin dry bulk carriers and the associated loss of life and cargo in the early 90s, where structural failure may have been a contributory factor, the International Association of Classification Societies (IACS) carried out comprehensive investigations in order to identify the likely causes of these ship casualties and introduced measures to minimise their recurrence.

The evidence available indicates that a majority of the ships lost were over 15 years of age and were predominantly carrying iron ore at the time of loss. The investigations identified that the principal factors contributing to the loss of these ships were corrosion and cracking of the structure within the cargo spaces. Other factors which could have contributed to the hull structural failure were over-stressing of the hull structure due to incorrect loading of the cargo holds and physical damage to the side structure during cargo discharging operations.

**1.2 Actions Taken By IACS**

To minimise the possibility of further casualties occurring on dry bulk carriers, a number of actions have already been implemented by the IACS Member Societies and ongoing work is being carried out which will bring further enhancements to the safety of these ships. The following list of actions have been implemented by IACS Member Societies. The results of the ongoing work will be made available to all interested parties in due course.

**1991**

The introduction of corrosion protection coating requirements for all salt water ballast spaces for new ships.

**1992**

Publication of the IACS brochure, 'Bulk Carriers: Guidance and Information to Shipowners and Operators', with the intention of advising the shipping community with regard to the potential problems of this ship type.

**1993**

The introduction of minimum thickness requirements for the webs of side shell frames in cargo areas for new ships.

The introduction of corrosion protection coating requirements for side shell structure and transverse bulkheads in all cargo hold spaces for new ships.

The introduction of more rigorous survey requirements. The implementation of the Enhanced Survey Programme (ESP) for bulk carriers by all IACS Member Societies at the first annual, intermediate or special survey from July 1993.

**1994**

Publication of the IACS Manual, 'Bulk Carriers: Guidelines for Surveys, Assessment and Repair of Hull Structures', providing guidance to surveyors of IACS Member Societies and other interested parties involved in the survey, assessment and repair of hull structures for bulk carriers.

**No.**  
**46**  
(cont)

**1995**

An implementation date of not later than 1st July 1997 has been agreed upon for the requirement that all existing bulk carriers of 150 metres in length and greater are to be fitted with an approved loading instrument.

**1996**

The introduction, as of January 1997, of an accelerated Enhanced Survey Program of the cargo holds of existing single skin bulk carriers which are 10 years of age or older, of 150 metres length or greater, and which have not commenced an enhanced special survey.

Improvements in the Enhanced Survey Program for all existing bulk carriers of 10 years of age or older which will further enhance close-up surveys and thickness measurements at annual, intermediate and special surveys.

A-The review of the requirements for loading instruments.

**2005**

The Common Structural Rules for Bulk Carriers (CSR-BC) were unanimously adopted by the IACS Council for implementation on 1 April 2006. The Rules were based on sound technical grounds, and achieved the goals of more robust and safer ships.

**2015**

IACS decided to harmonise the Common Structural Rules for Oil Tankers (CSR-OT) and the Common Structural Rules for Bulk Carriers (CSR-BC) in a single set of Rules "Common Structural Rules for Bulk Carriers and Oil Tankers" (CSR BC & OT) comprising of two parts; Part One gives requirements common to both Bulk Carriers and Double Hull Oil Tankers and Part Two provides additional specialised requirements specific to either Bulk Carriers or Double Hull Oil Tankers.

### **1.3 Aims of This Publication**

IACS Member Societies and other parties involved in bulk cargo shipping are concerned with the possible damage and loss of bulk carriers carrying heavy cargoes. Of particular concern are the potential problems which may result during operations such as the introduction of very high capacity loading systems, lack of communication between ship and terminal and inadequate planning of cargo operations. It is also of concern to IACS Members that some seafarers, and ship and cargo operators do not have a clear understanding of the limitations imposed by the ship's classification society regarding the strength capability of the hull structure.

IACS considers that a positive step must now be taken to provide adequate guidance and information to all parties involved in the loading and unloading of dry bulk carriers so that there is an awareness and better understanding of the possible problems that may be encountered. To serve this purpose, it is the intention of IACS to make this publication available to all shipowners, ship masters, ship and cargo terminal operators and other interested parties worldwide.



# No. 46

(cont)

## 2. Loads and Hull Structure

### 2.1 Typical Bulk Carrier Structural Configuration

The most widely recognised structural arrangement identified with bulk carriers is a single deck ship with a double bottom, hopper tanks, single skin transverse framed side shell, topside tanks and deck hatchways. For guidance on the structural terminology adopted in this publication, a typical structural arrangement of a bulk carrier cargo hold space is illustrated in Figure 1. In addition, a typical transverse section in way of a cargo hold and a longitudinal section of a typical corrugated transverse watertight bulkhead are illustrated in Figures 2 and 3 respectively.

Bulk carrier design does not alter significantly with size; fundamentally, a bulk carrier of 30,000 tonnes deadweight usually has the same structural configuration as that of a ship of 80,000 tonnes deadweight.

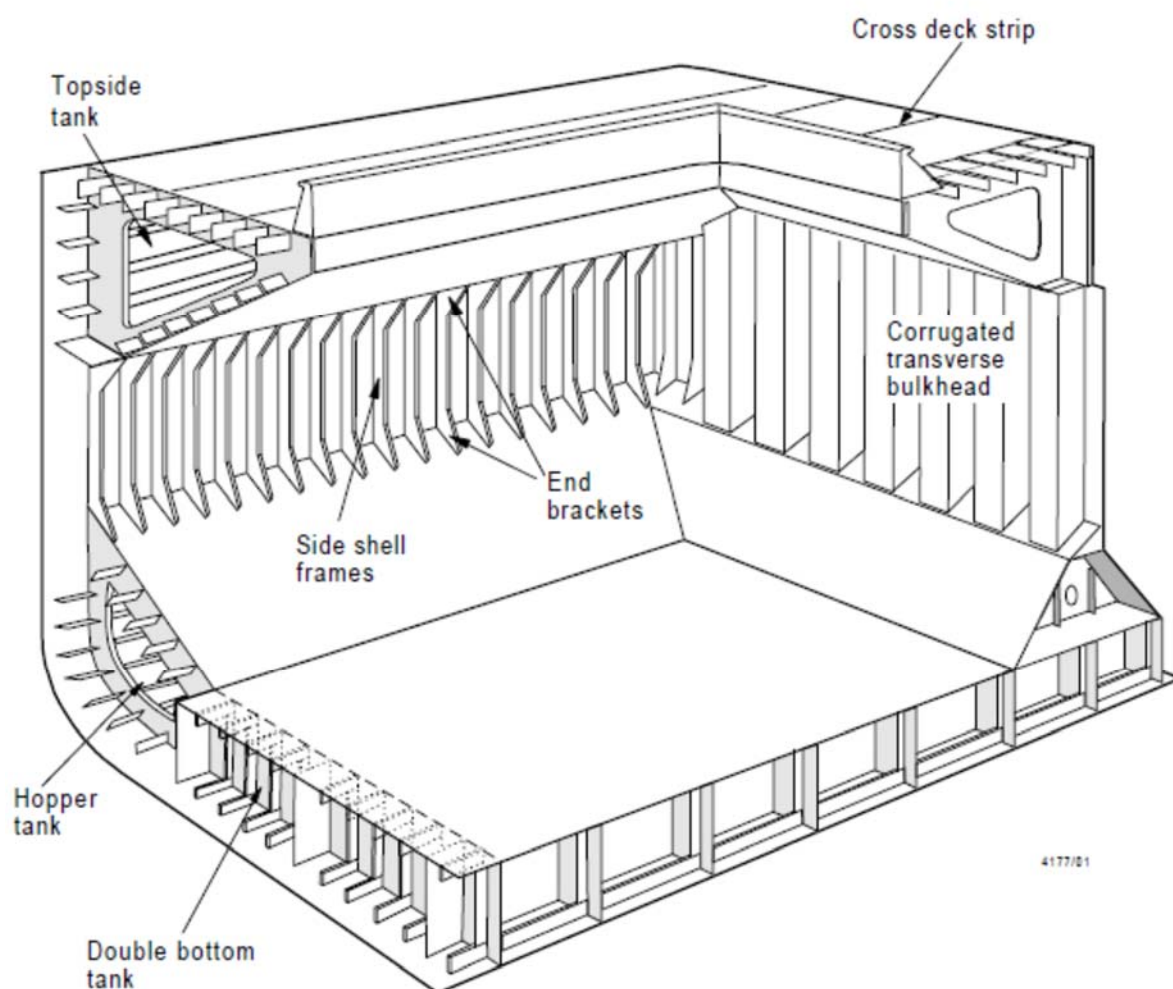

**Figure 1: Typical Cargo Hold Structural Configuration for a Single Side Skin Bulk Carrier**



# No. 46

(cont)

In general, the plating comprising structural items such as the side shell, bottom shell, strength deck, transverse bulkheads, inner bottom and topside and hopper tank sloping plating provides local boundaries of the structure and carries static and dynamic pressure loads exerted by, for example, the cargo, bunkers, ballast and the sea. This plating is supported by secondary stiffening members such as frames or longitudinals. These secondary members transfer the loads to primary structural members such as the double bottom floors and girders or the transverse web frames in topside and hopper tanks, etc. see figure 2.

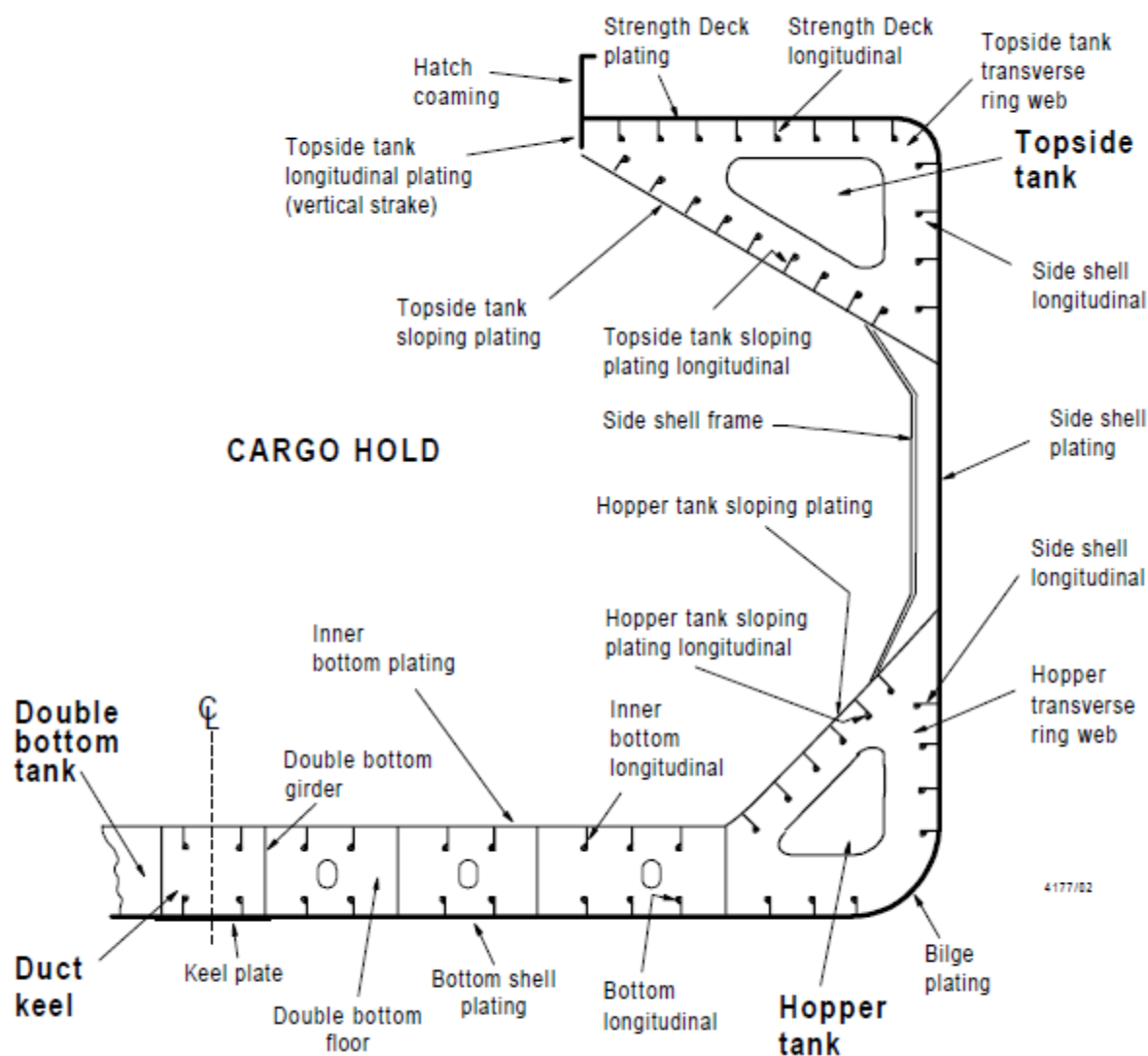
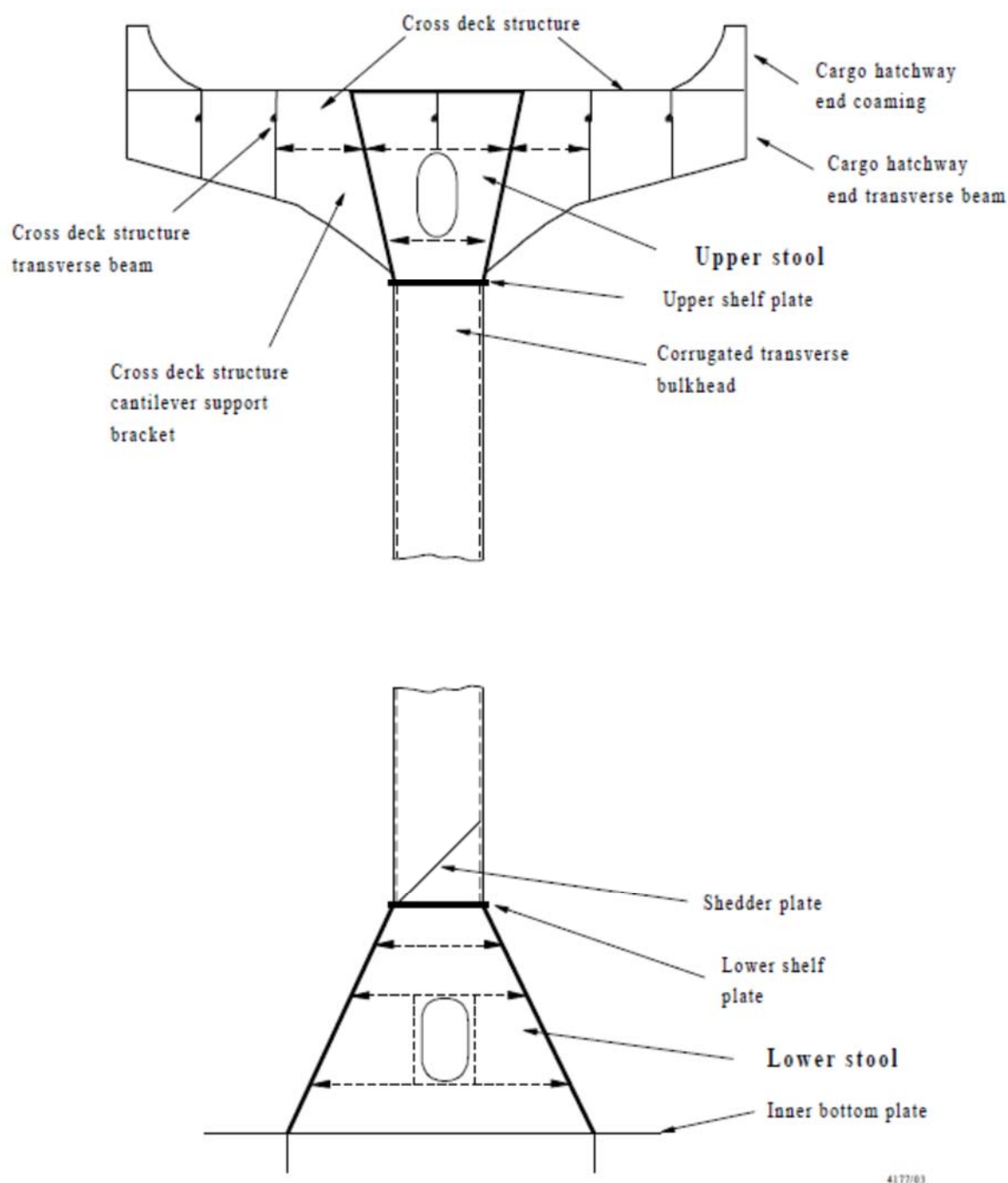

Figure 2: Nomenclature for Typical Transverse Section in way of a Cargo Hold

**No.  
46**  
(cont)

The transverse bulkhead structures, including its upper and lower stools, see figure 3, together with the cross deck and the double bottom structures are the main structural members which provide the transverse strength of the ship to prevent the hull section from distorting. In addition, if ingress of water into any one hold has occurred, the transverse watertight bulkheads prevent progressive flooding of other holds.



**Figure 3: Nomenclature for Typical Corrugated Transverse Watertight Bulkhead**

# No. 46

(cont)

## 2.2 Design Limitations

### 2.2.1 General

All ships are designed with limitations imposed upon their operability to ensure that the structural integrity is maintained. Therefore, exceeding these limitations may result in over-stressing of the ship's structure which may lead to catastrophic failure. The ship's approved loading manual provides a description of the operational loading conditions upon which the design of the hull structure has been based. The loading instrument provides a means to readily calculate the still water shear forces and bending moments, in any load or ballast condition, and assess these values against the design limits.

A ship's structure is designed to withstand the static and dynamic loads likely to be experienced by the ship throughout its service life.

The loads acting on the hull structure when a ship is floating in still (~~calm~~) water are static loads. These loads are imposed by the:

- Actual weight of the ship's structure, outfitting, equipment and machinery.
- Cargo load (weight).
- Bunker and other consumable loads (weight).
- Ballast load (weight).
- Hydrostatic pressure (sea water pressure acting on the hull).

Dynamic loads are those additional loads exerted on the ship's hull structure through the action of the waves and the effects of the resultant ship motions (i.e. acceleration forces, slamming and sloshing loads). Sloshing loads may be induced on the ship's internal structure through the movement of the fluids in tanks/holds whilst slamming of the bottom shell structure forward may occur due to emergence of the fore end of the ship from the sea in heavy weather.

Cargo over-loading in individual hold spaces will increase the static stress levels in the ship's structure and reduce the strength capability of the structure to sustain the dynamic loads exerted in adverse sea conditions.

Carriage of intended cargoes which may liquefy at moisture content in excess of the transportable moisture limit or by any other causes will be specially considered in the strength of the cargo hold boundaries.

### 2.2.2 Hull Girder Shear Forces and Bending Moments

All bulk carriers classed with IACS Member Societies are assigned permissible still water shear forces (SWSF) and still water bending moment (SWBM) limits. There are normally two sets of permissible SWSF and SWBM limits assigned to each ship, namely:

- Seagoing (~~at sea~~) SWSF and SWBM limits (at sea).
- Harbour (~~in port~~) SWSF and SWBM limits (in port).

In addition, the permissible SWSF and SWBM limits in the hold flooded conditions are assigned to BC-A and BC-B ships defined in 2.3.1

The seagoing SWSF and SWBM limits in the normal or the flooded conditions, whichever is applicable and/or more stringent, are not to be exceeded when the ship ~~puts to sea~~ leaves the harbour or during any part of a seagoing voyage. In harbour, where the ship is in sheltered water and is subjected to reduced dynamic loads, the hull girder is permitted to

# No. 46

(cont)

carry a higher level of stress imposed by the static loads. The harbour SWSF and SWBM limits are not to be exceeded during any stage of harbour cargo operations.

When a ship is floating in still water, the ship's lightweight (the weight of the ship's structure and its machinery) and deadweight (all other weights, such as the weight of the bunkers, ballast, provisions and cargo) are supported by the global buoyancy ~~up thrust~~ up thrust acting on the exterior of the hull. Along the ship's length there will be local differences in the vertical forces of buoyancy and the ship's weight. These unbalanced net vertical forces acting along the length of the ship will cause the hull girder to shear and to bend, see figures 4, 5 and 6, inducing a vertical still water shear force (SWSF) and still water bending moment (SWBM) at each section of the hull.

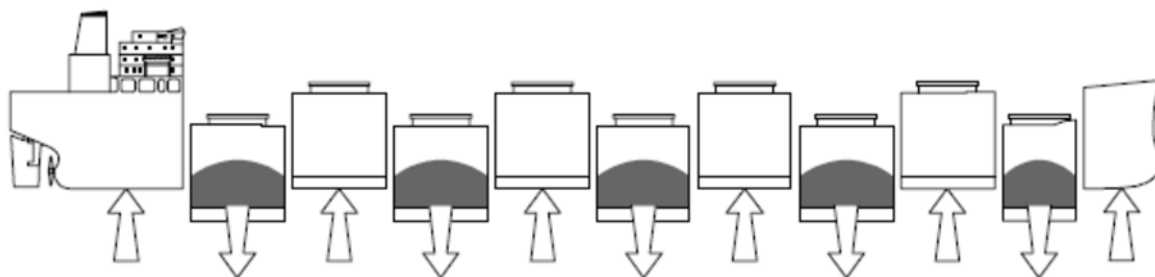

**Figure 4: Shearing Action of the Hull Girder in Still Water**

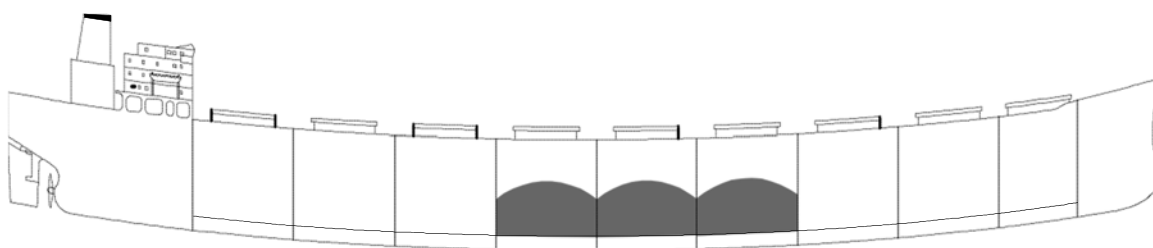

**Figure 5: Bending Action of the Hull Girder "Sagging" in Still Water  
(Exaggerated Condition - Illustration Purposes Only)**

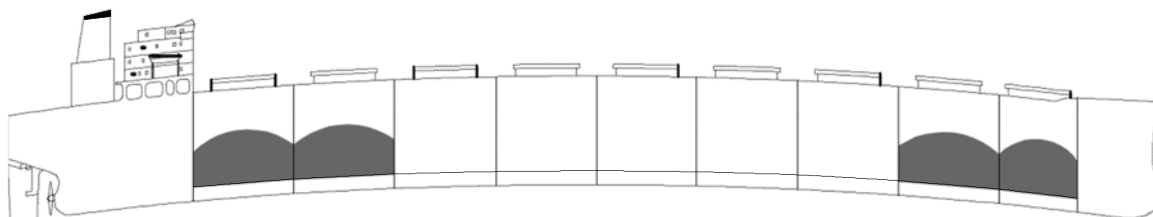

**Figure 6: Bending Action of the Hull Girder "Hogging" in Still Water  
(Exaggerated Condition - Illustration Purposes Only)**

At sea, the ship is subjected to cyclical shearing and bending actions induced by continuously changing wave pressures acting on the hull. These cyclical shearing and bending actions give rise to an additional component of dynamic, wave induced, shear force and bending moment in the hull girder. At any one time, the hull girder is subjected to a combination of still water and wave induced shear forces and bending moments.

# No. 46

(cont)

The stresses in the hull section caused by these shearing forces and bending moments are carried by continuous longitudinal structural members. These structural members are the strength deck, side shell and bottom shell plating and longitudinals, inner bottom plating and longitudinals, double bottom girders and topside and hopper tank sloping plating and longitudinals, which are generally defined as the ship hull girder.

Examples of permissible and calculated SWSF and SWBM are shown in figures 7 and 8 respectively.

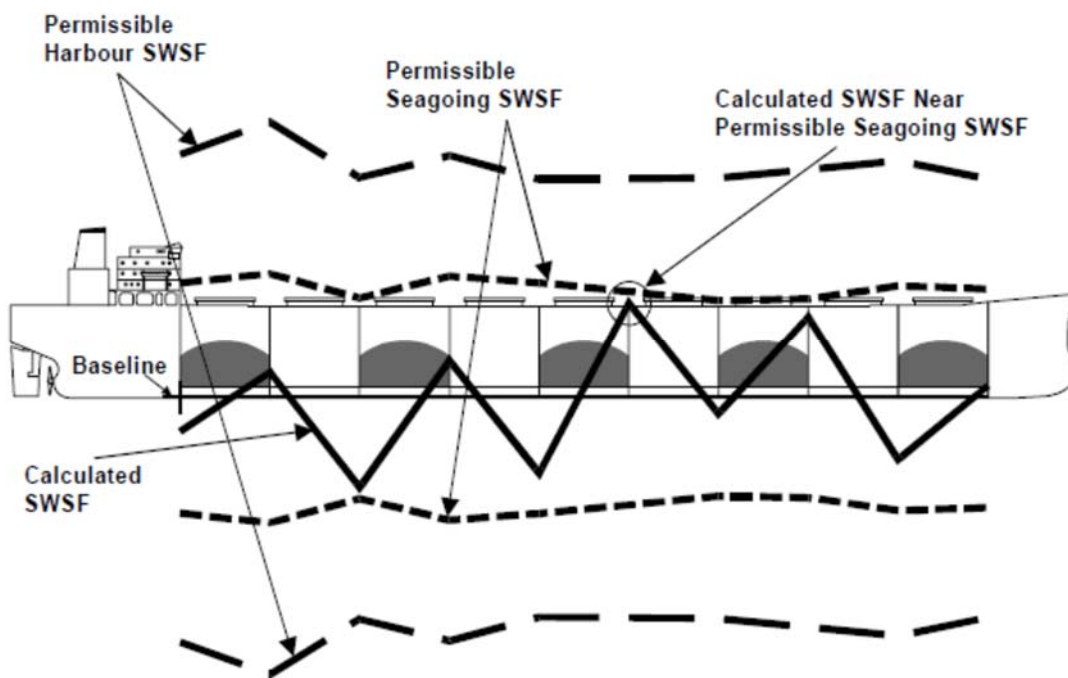

Figure 7: Relationship of the Permissible SWSF and the Calculated SWSF

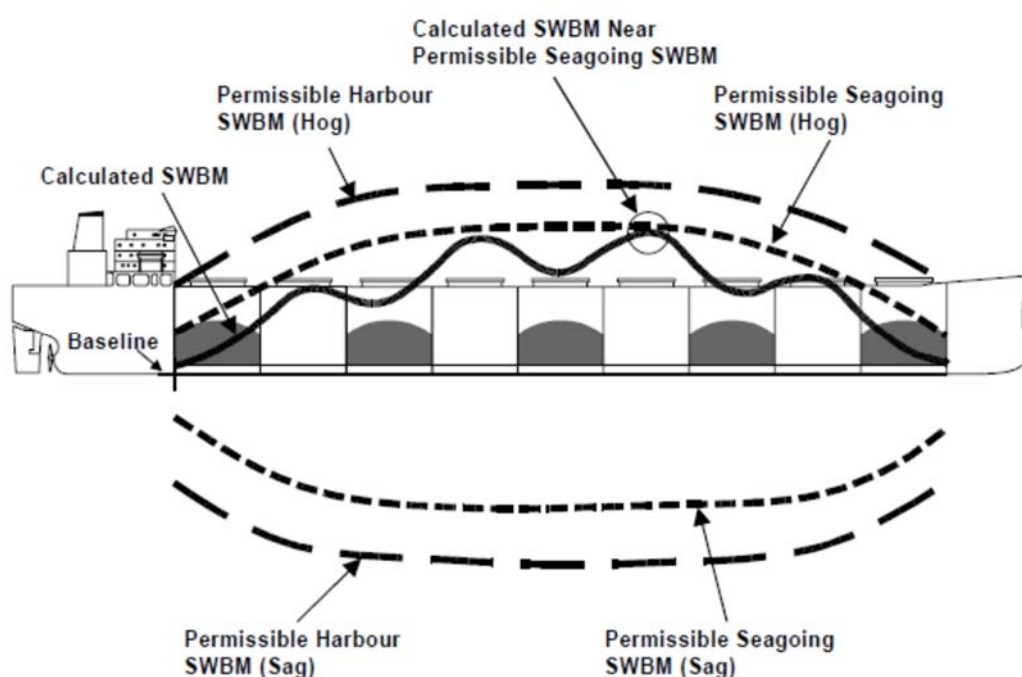

Figure 8: Relationship of the Permissible SWBM and the Calculated SWBM

# No. 46

(cont)

## 2.2.3 Local Strength of Transverse Bulkhead, Double Bottom and Cross Deck Structure

To enhance safety and flexibility, ~~some~~ all bulk carriers of 150m in length and above are provided with local loading criteria which define the maximum allowable cargo weight in each cargo hold, and each pair of adjacent cargo holds (i.e. block hold loading condition), for various ship draught conditions. The local loading criteria is normally provided in tabular and diagrammatic form (hold mass curves).

Over-loading will induce greater stresses in the double bottom, transverse bulkheads, hatch coamings, hatch corners, main frames and associated brackets of individual cargo holds, see figure 9.

The double bottom, cross deck and transverse bulkhead structures are designed for specific cargo loads and sailing draught conditions. These structural configurations are sensitive to the net vertical load acting on the ship's double bottom. The net vertical load is the difference between the vertical downward weight of the cargo and water ballast in the double bottom and the hopper ballast tanks in way of the cargo hold and the upward buoyancy force which is dependent on the ship's draught.

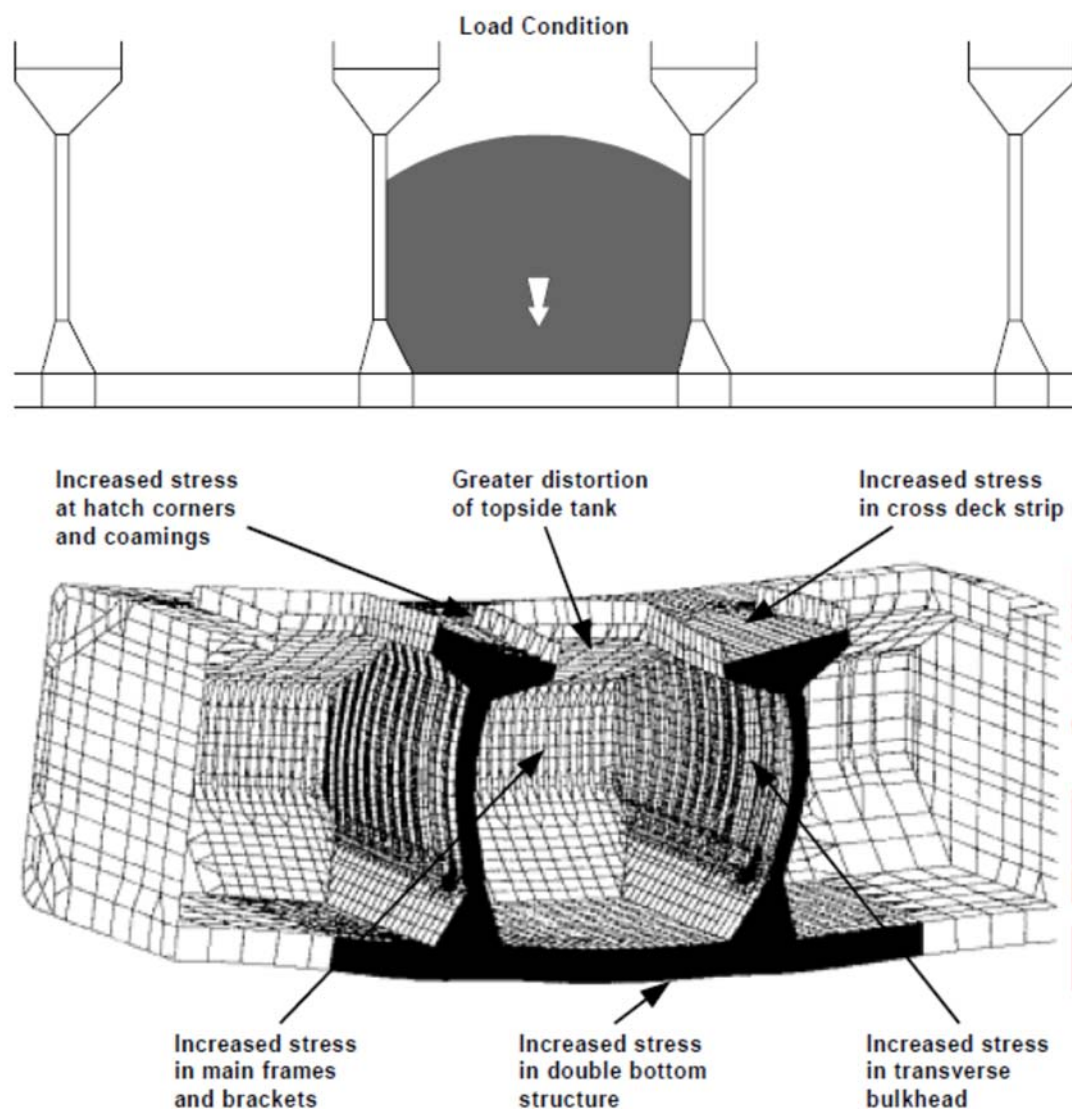
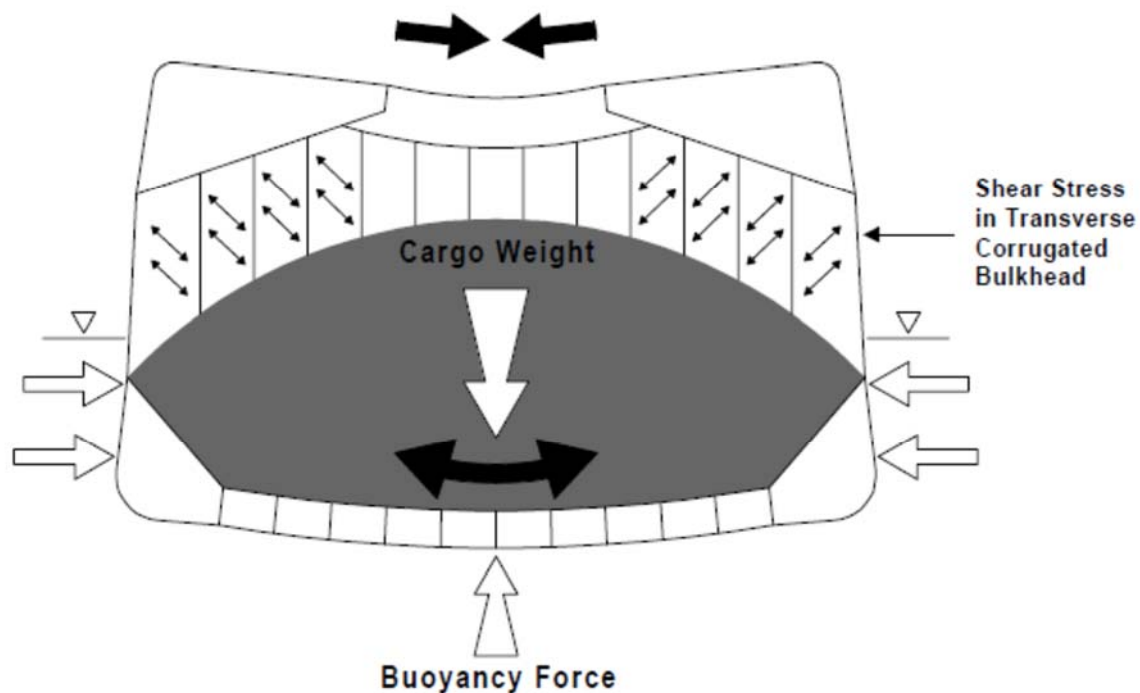

**Figure 9: Exaggerated Deformation of the Localised Structure due to Overloading of the Cargo Hold**

**No.  
46**

(cont)

Overloading of the cargo hold in association with insufficient draught will result in an excessive net vertical load on the double bottom which may distort the overall structural configuration in way of the hold, see figures 10 and 11.



**Figure 10: Shearing of the Transverse Corrugated Bulkhead and Compression of the Cross Deck**

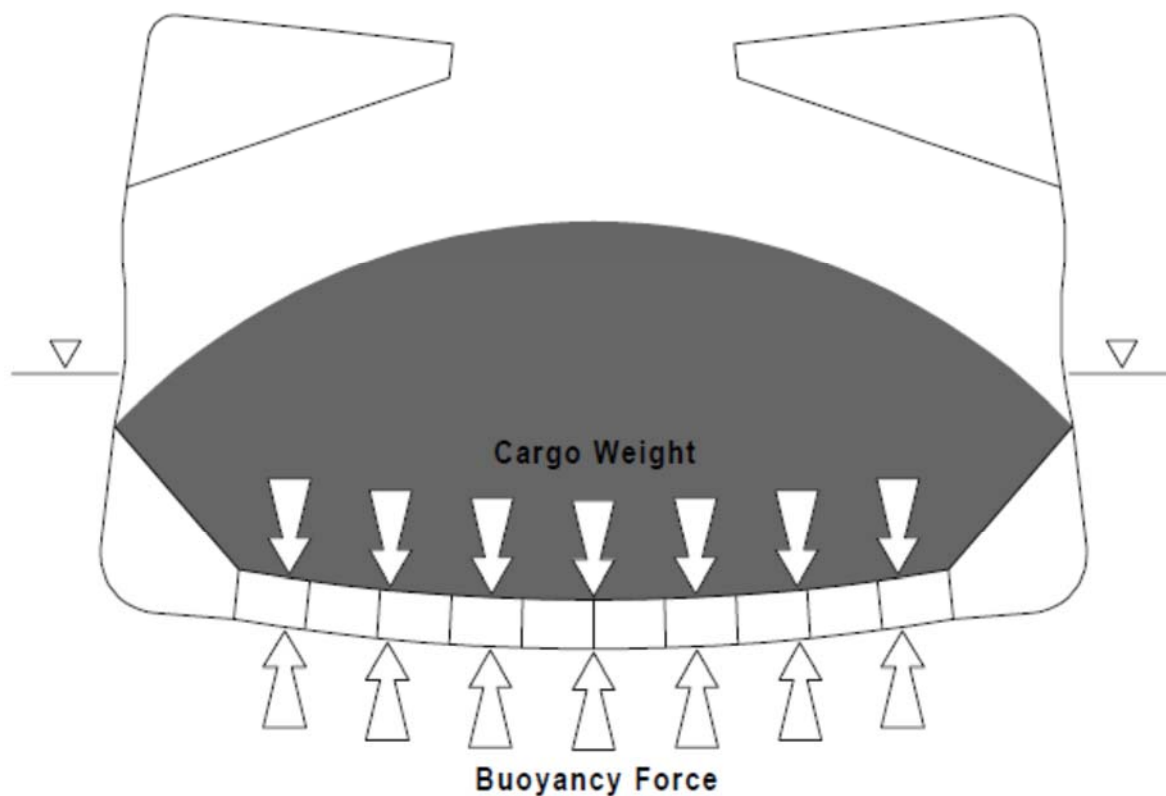

**Figure 11: Excessive Flexural Deformation of the Double Bottom Structure**



# No. 46

(cont)

A typical Local Loading Diagram for a cargo hold (strengthened hold) combined with the adjacent hold limits, of a bulk carrier, are shown in figure 12.

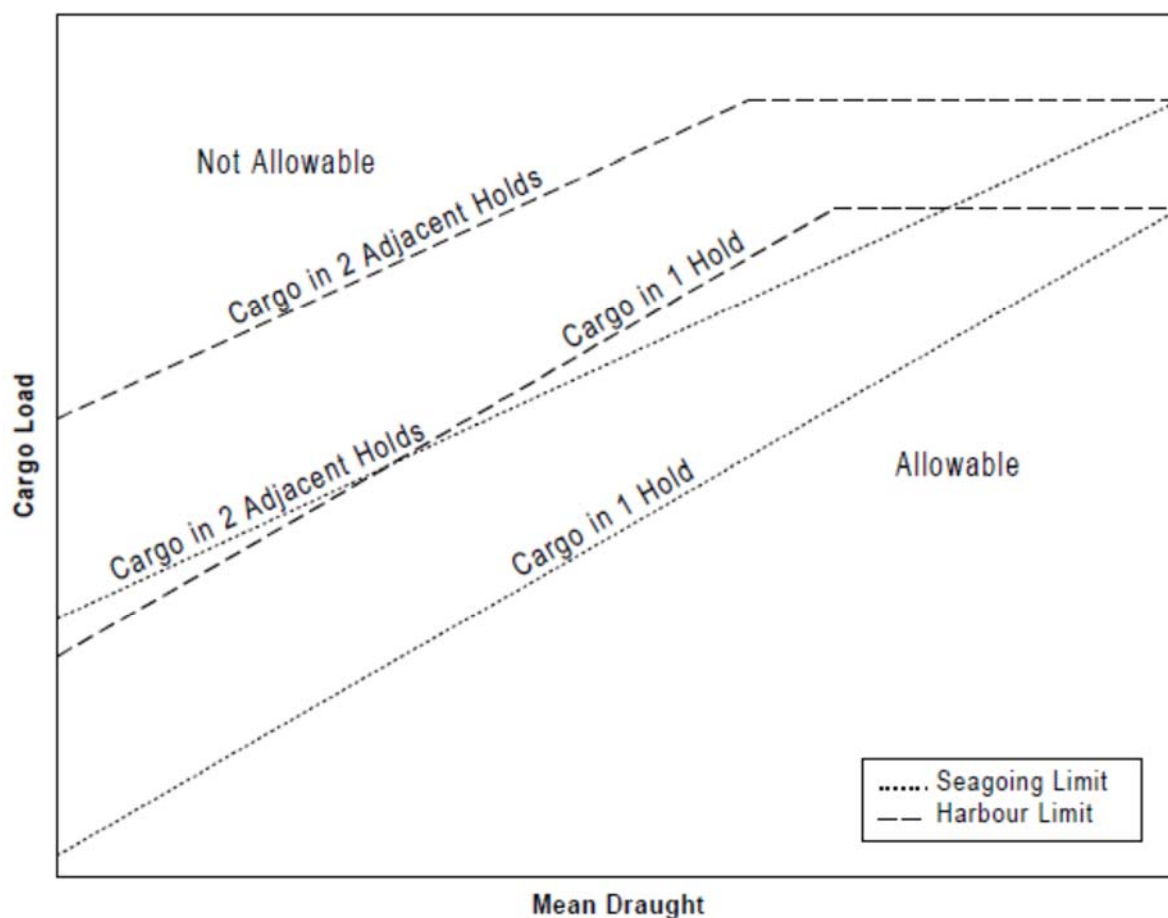

**Figure 12: An Example of a Local Loading Diagram for a Bulk Carrier**

The important trend to note from the local loading diagram is that there is a reduction in the cargo carrying capacity of a hold with a reduction in the mean draught. To exceed these limits will impose high stresses in the ship's structure in way of the over-loaded cargo hold. There are two sets of local loading criteria depending upon the cargo load distribution namely, individual hold loading or two adjacent hold loading.

The allowable cargo loads for each hold or combined cargo loads in two adjacent holds are usually provided in association with empty double bottom and hopper wing ballast tanks directly in way of the cargo hold. When water ballast is carried in the double bottom and hopper wing tanks, the maximum allowable cargo weight should be obtained by deducting the weight of water ballast being carried in the tanks in way of the cargo hold.

The maximum cargo loads given in the Local Loading Criteria should be considered in association with the mean draught in way of the cargo hold(s). In the case of a single cargo hold, the ship draught at the mid-length of the hold should be used. For two adjacent cargo holds, the average of the draught in the mid-length of each cargo hold should be used.

# No. 46

(cont)

## 2.3 Cargo Distributions Along Ship's Length

### 2.3.1 General

Bulk carriers are designed and approved to carry a variety of cargoes. The distribution of cargo along the ship's length has a direct influence on both the global bending and shearing of the hull girder and on the stress in the localised hull structures.

The more commonly adopted cargo distributions are:

- Homogeneous hold loading condition.
- Alternate hold loading condition.
- Block hold loading condition.
- Part hold loading condition.

It is noted that there are additional service features for assigned BC-A, BC-B and BC-C notations with following requirements for bulk carrier having the ship rule length L of 150 m or above:

- a) BC-A: For bulk carriers designed to carry dry bulk cargoes of cargo density 1.0 t/m<sup>3</sup> and above with specified holds empty at maximum draught in addition to BC-B conditions.
- b) BC-B: For bulk carriers designed to carry dry bulk cargoes of cargo density of 1.0 t/m<sup>3</sup> and above with all cargo holds loaded in addition to BC-C conditions.
- c) BC-C: For bulk carriers designed to carry dry bulk cargoes of cargo density less than 1.0 t/m<sup>3</sup>.

As per the CSR BC&OT, Pt 1, Ch 4, Sec 8, [4.1] and [4.2], the following additional service features are to be provided giving further detailed description of limitations to be observed during operation as a consequence of the design loading condition applied during the design in the following cases:

- {Maximum cargo density in t/m<sup>3</sup>} for additional service features BC-A and BC-B if the maximum cargo density is less than 3.0 t/m<sup>3</sup>
- {No MP} for all additional service features when the ship has not been designed for loading and unloading in multiple ports
- {Holds a, b, ... may be empty} for additional service feature BC-A
- {Block loading} for additional service feature BC-A, when the ship is intended to operate in alternate block load condition

For CSR bulk carriers contracted for construction before 1 July 2015, the requirements in CSR BC, Ch 4, Sec 8, [2] (when applicable) and Ch 4, Sec 8, [4] should be complied with, so has to satisfy with the hull girder longitudinal strength requirements.

**No.**  
**46**  
(cont)

### 2.3.2 Homogeneous Hold Loading Conditions (Fully Loaded)

A homogeneous hold loading condition refers to the carriage of cargo, evenly distributed in all cargo holds, see figure 13. This loaded distribution, in general, is permitted for all bulk carriers and is usually adopted for the carriage of light (low density) cargoes, such as coal and grain. However, heavy (high density) cargoes such as iron ore may be carried homogeneously for BC-A and BC-B ships. For large ships (e.g. VLOC) the fully loaded condition is currently the most commonly utilized loading condition and should be preferably adopted in order to reduce the shear force occurrence between cargo holds.

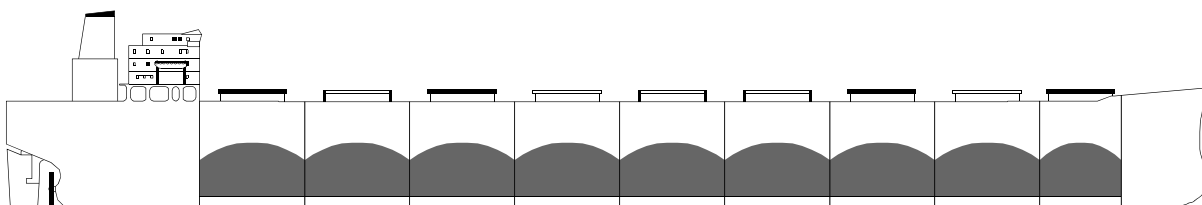
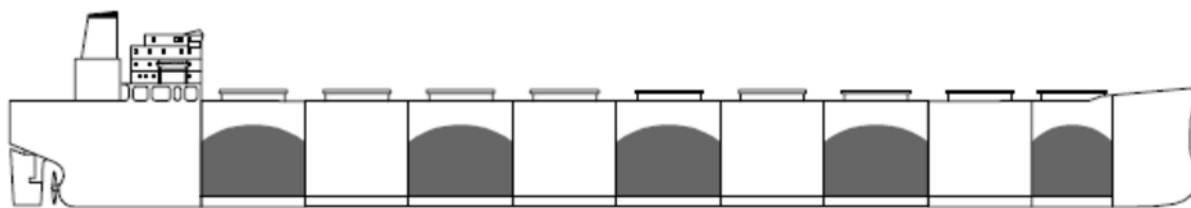

**Figure 13: Homogeneous Hold Loading Condition (Fully Loaded)**

### 2.3.3 Alternate Hold Loading Conditions (Fully Loaded)

Heavy cargo, such as iron ore, is often carried in alternate cargo holds on bulk carriers, see figure 14. It is common for large bulk carriers to stow high density cargo in odd numbered holds with the remaining holds empty. This type of cargo distribution will raise the ship's centre of gravity, which eases the ship's rolling motion. When high density cargo is stowed in alternate holds, the weight of cargo carried in each hold is approximately double that carried in a homogeneous load distribution. To support the loading of the heavy cargo in the holds, the local structure needs to be specially designed and reinforced. It is important to note that the holds which remain empty, with this type of cargo distribution, have not been reinforced for the carriage of heavy cargoes with a non-homogeneous distribution.

Ships not approved for the carriage of heavy cargoes in alternate holds by their classification society must not adopt this cargo load distribution.

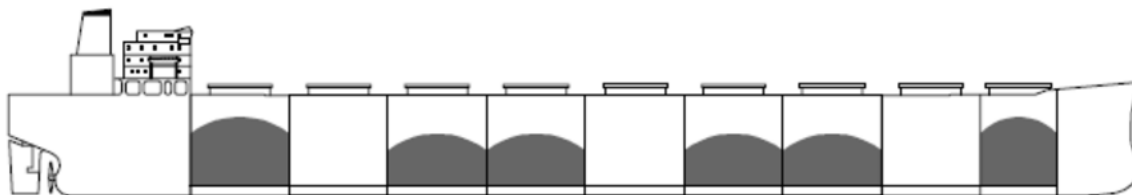

**Figure 14: Alternate Hold Loading Condition (Fully Loaded)**

### 2.3.4 Block Hold Loading and Part Loaded Conditions

A block hold loading condition refers to the stowage of cargo in a block of two or more adjoining cargo holds with the cargo holds adjacent to the block of loaded cargo holds empty, see figure 15. In many cases, block hold loading is adopted when the ship is partly loaded. Part loaded and block hold loading conditions are not usually described in the ship's loading manual unless they are specially requested to be considered in the design of the ship. When adopting a part loaded condition, to avoid over-stressing of the hull structure, careful consideration needs to be given to the amount of cargo carried in each cargo hold and the anticipated sailing draught.

**No.  
46**  
(cont)



**Figure 15: Block Hold Loading Condition**

When a ship is partly loaded, the cargo transported is less than the full cargo carrying capacity of the ship. Hence, the sailing draught of the ship is likely to be less than its maximum design draught.

The weight of cargo in each hold must be adequately supported by the buoyancy ~~upthrust~~ up thrust acting on the bottom shell. A reduction in the ship's draught causes a reduction in the buoyancy ~~upthrust~~ up thrust on the bottom shell to counteract the downward force exerted by the cargo in the hold. Therefore, when a ship is partly loaded with a reduced draught, it may be necessary to reduce the amount of cargo carried in any hold.

To enable cargoes to be carried in blocks, the cross deck and double bottom structure needs to be specially designed and reinforced. Block loading results in higher stresses in the localised structures in way of the cross deck and double bottom structures and higher shear stress in the transverse bulkheads between the block loaded holds. The weight of cargo that can be carried in the block of cargo holds needs to be specially considered against the ship's sailing draught and the capability of the structure. In general, the cargo load that can be carried in blocks is much less than the sum of the full cargo capacity of the individual holds at the maximum draught condition.

Part loaded and block hold loading conditions should only be adopted in either of the following situations:

- The loading distributions are described in the ship's loading manual. In this case, the ship's structure has been approved for the carriage of cargo in the specified loading condition and the loading conditions described in the ship's loading manual should be adhered to, or,
- The ship is provided with a set of approved local loading criteria which define the maximum cargo weight limit as a function of ship's mean draught for each cargo hold and block of cargo hold(s). In this case, it is necessary to ensure that the amount of cargo carried in each hold satisfies the cargo weight and draught limits specified by the local loading criteria and the hull girder SWSF and SWBM values are within their permissible limits.

It is noted that for both alternative and block/part hold loadings, even the loading conditions have been approved and listed in the loading manual and meet the requirements of the loading instrument, the ship owners/operators are generally still unwilling to adopt these loading conditions in practice. This is because the alternative and block/part hold loadings have the significant impact on the localized structures due to the higher shear stress as mentioned above.

### **2.3.5 The change of weight distribution arising from fuel and ballast water**

The loads induced by fuel and ballast water can have an effect on the weight distribution along the ship length. Therefore, considerations should be also given to the weight of fuel and/or ballast water, and its change. In particular, the longitudinal stress increased during the process of the ballast water exchange requires a special attention by a master or a ship's officer in charge.

# No. 46

(cont)

## 3. Onboard Loading Guidance Information

### 3.1 Loading Manual

It is a statutory requirement of the International Load Line Convention that, noting exemptions, "the Master of every new vessel be supplied with sufficient information, in an approved form, to enable him to arrange for the loading and ballasting of his ship in such a way as to avoid the creation of any unacceptable stresses in the ship's structure."

Where the Master feels that he has insufficient information regarding the structural limitations or requires advice on the interpretation of the classification society's structural limitations imposed on his ship, advice should be sought from the ship's classification society.

The ship's approved loading manual is an essential onboard documentation for the planning of cargo stowage, loading and discharging operations. This manual, for bulk carriers describes:

- ~~The loading conditions on which the design of the ship has been based, including permissible limits of still water bending moments and shear force and bending-moments.~~
- ~~The results of calculations of SWSF and SWBM for each included loading condition.~~
- ~~The allowable local loading of the structure.~~
- The results of calculations of still water bending moments (SWBM), shear forces (SWSF) and where applicable, limitations due to torsional and lateral loads. SWSF and SWBM for each included loading condition.
- Envelope results and permissible limits of still water bending moments and shear forces in the hold flooded as applicable.
- The cargo hold(s) or combination of cargo holds that might be empty at full draught. If no cargo hold is allowed to be empty at full draught, this is to be clearly stated in the loading manual.
- Maximum allowable and minimum required mass of cargo and double bottom contents of each hold as a function of the draught at mid-hold position.
- Maximum allowable and minimum required mass of cargo and double bottom contents of any two adjacent holds as a function of the mean draught in way of these holds. This mean draught may be calculated by averaging the draught of the two mid-hold positions.
- Maximum allowable tank top loading together with specification of the nature of the cargo for cargoes other than bulk cargoes.
- Maximum allowable load on deck and hatch covers, where applicable.
- The maximum rate of ballast change together with the advice that a load plan is to be agreed with the terminal on the basis of the achievable rates of change of ballast.
- Operational limits The relevant operational limitations.

The ship's loading manual is a ship specific document, the data contained therein is only

# No. 46

(cont)

applicable to the ship for which it has been approved.

## 3.2 Loading Instrument

The loading instrument is an invaluable shipboard calculation tool which assists the ship's cargo officer in:

- Planning and controlling cargo and ballasting operations.
- Rapidly calculating SWSF and SWBM for any load condition.
- Identifying the imposed structural limits which are not to be exceeded.

It is important to note that the loading instrument is not a substitute for the ship's loading manual. Therefore, the officer in charge should also refer to the loading manual when planning or controlling cargo operations.

A loading instrument or loading computer is an instrument, which can be either an analogue or digital system, by means of which it can be easily and quickly ascertained that, at specified read-out points, the still water bending moments, shear forces, and the still water torsional moments and lateral loads, where applicable, in any load or ballast condition will not exceed the specified permissible values. Modern loading instruments consist of approved computational software operating on a shipboard digital PC computer. ~~The ship's loading instrument is a ship-specific onboard equipment and the results of the calculations are only applicable to the ship for which it has been approved.~~

In addition to these requirements, it shall ascertain as applicable that:

- the mass of cargo and double bottom contents in way of each hold as a function of the draught at mid-hold position
- the mass of cargo and double bottom contents of any two adjacent holds as a function of the mean draught in way of these holds
- the still water bending moment and shear forces in the hold flooded conditions, are within permissible values

The ship's loading instrument is a ship specific onboard equipment and the results of the calculations are only applicable to the ship for which it has been approved. Single point loading instruments are not acceptable.

An operational manual is always to be provided for the loading instrument

~~The operation manual is an essential part of the loading instrument and should be kept onboard at all times. The ship's deck officers should familiarise themselves with the operation of the onboard loading instrument.~~

The loading instrument is to be checked for accuracy at regular intervals by the ship's Master by applying test loading conditions.

At each Special Survey this checking is to be done in the presence of the Surveyor.

~~IACS Member Societies urge the ship's Master to check the accuracy of the loading instrument against the test cargo loading conditions at regular intervals.~~

# No. 46 (cont)

## 4. Planning and Control of Cargo Loading and Unloading Operations

### 4.1 Preparation for Cargo Operations

#### 4.1.1 Cargo and Port Information

To make it possible to plan the cargo stowage, loading and unloading sequences, the cargo terminal should provide the ship with the following information well in advance:

- Cargo characteristics; stowage factor, angle of repose, amounts and special properties.
- Cargo availability and any special requirements for the sequencing of cargo operations.
- Characteristics of the loading or unloading equipment including number of loaders and unloaders to be used, their ranges of movement, and the terminal's nominal and maximum loading and unloading rates, where applicable.
- Minimum depth of water alongside the berth and in the fairway channels.
- Water density at the berth.
- Air draught restrictions at the berth.
- Maximum sailing draught and minimum draught for safe manoeuvring permitted by the port authority.
- The amount of cargo remaining on the conveyor belt which will be loaded onboard the ship after a cargo stoppage signal has been given by the ship.
- Terminal requirements/procedures for shifting ship.
- Local port restrictions, for example, bunkering and deballasting requirements etc.

Cargo trimming is a mandatory requirement for some cargoes, especially where there is a risk of the cargo shifting ~~or where liquefaction could take place~~. IACS recommends that the cargo in all holds be trimmed in an attempt to minimise the risk of cargo shift.

Transportation of mineral concentrates, such as copper, iron, lead nickel or bauxite could be hazardous. The attention is drawn to the applicable requirements of the International Maritime Solid Bulk Cargoes (IMSBC) code. Depending on the cargo categories (A, B or C) of the code, test of Transportable Moisture Limit (TML) is to be performed to mitigate the risks of cargo liquefaction creating large free surface effect in cargo hold.

The ship's Master should be aware of the harmful effects of corrosive and high temperature cargoes and any special cargo transportation requirements. Ship Masters, deck officers, charterers and stevedores should be familiar with the relevant IMO Codes (for example, the IMO Code of Safe Practice for Solid Bulk Cargoes, the IMO Code of Practice for the Safe Loading and Unloading of Dry Bulk Carriers (~~to be published~~ BLU Code) and the SOLAS Convention).



**No.**  
**46**  
(cont)

#### 4.1.2 Devising a Cargo Stowage Plan and Loading/Unloading Plan

The amount and type of cargo to be transported and the intended voyage will dictate the proposed departure cargo and/or ballast stowage plan. The officer in charge should always refer to the loading manual to ascertain an appropriate cargo load distribution, satisfying the imposed limits on structural loading.

There are two stages in the development of a safe plan for cargo loading or unloading:

- Stage 1: Given the intended voyage, the amount of cargo and/or water ballast to be carried and imposed structural and operational limits, devise a safe departure condition, known as the stowage plan.
- Stage 2: Given the arrival condition of the ship and knowing the departure condition (stowage plan) to be attained, devise a safe loading or unloading plan that satisfies the imposed structural and operational limits.

In the event that the cargo needs to be distributed differently from that described in the ship's loading manual, stress and displacement calculations are always to be carried out to ascertain, for any part of the intended voyage, that:

- The still water shear forces and bending moments along the ship's length are within the permissible Seagoing limits.
- If applicable, the weight of cargo in each hold, and, when block loading is adopted, the weights of cargo in two successive holds are within the allowable Seagoing limits for the draught of the ship. These weights include the amount of water ballast carried in the hopper and double bottom tanks in way of the hold(s).
- The load limit on the tanktop and other relevant limits, if applicable, on local loading are not exceeded.

The consumption of ship's bunkers during the voyage should be taken into account when carrying out these stress and displacement calculations.

Whilst deriving a plan for cargo operations, the officer in charge must consider the ballasting operation to ensure:

- Correct synchronisation with the cargo operation.
- That the deballasting/ballasting rate is specially considered against the loading rate and the imposed structural and operational limits.
- That ballasting and deballasting of each pair of symmetrical port and starboard tanks is carried out simultaneously.

During the planning stage of cargo operations, stress and displacement calculations should be carried out at incremental steps commensurate with the number of pours and loading sequence of the proposed operation to ensure that:

- The SWSF and SWBM along the ship's length are within the permissible Harbour limits.
- If applicable, the weight of cargo in each hold, and, when block loading is adopted, the weights of cargo in two adjacent holds are within the allowable Harbour limits for the

# No. 46

(cont)

draught of the ship. These weights include the amount of water ballast carried in the hopper and double bottom tanks in way of the hold(s).

- The load limit on the tanktop and other relevant limits, if applicable, on local loading are not exceeded.
- At the final departure condition, the SWSF and SWBM along the ship's length are within the permissible Seagoing stress limits.

During the derivation of the cargo stowage, and the loading or unloading plan, it is recommended that the hull stress levels be kept below the permissible limits by the greatest possible margin.

A cargo loading/unloading plan should be laid out in such a way that for each step of the cargo operation there is a clear indication of:

- The quantity of cargo and the corresponding hold number(s) to be loaded/unloaded.
- The amount of water ballast and the corresponding tank/hold number(s) to be discharged/loaded.
- The ship's draughts and trim at the completion of each step in the cargo operation.
- The calculated value of the still water shear forces and bending moments at the completion of each step in the cargo operation.
- Estimated time for completion of each step in the cargo operation.
- Assumed rate(s) of loading and unloading equipment.
- Assumed ballasting rate(s)

The loading/unloading plan should indicate any allowances for cargo stoppage (which may be necessary to allow the ship to deballast when the loading rate is high), shifting ship, bunkering, draught checks and cargo trimming.

### 4.1.3 Ship/Shore Communication Prior to the Commencement of Cargo Operations

Effective means of communication are to be established between the ship's deck officers and the cargo terminal which shall remain effective throughout the cargo operation. This communication link should establish:

- An agreed procedure to STOP cargo operations.
- Personnel responsible for terminal cargo operations.
- The ship's officer responsible for the cargo loading/unloading plan and the officer in charge responsible for the on deck cargo operation.
- Confirmation of information received in advance.
- An agreed procedure for the terminal to provide the officer in charge with the loaded cargo weight, at frequent intervals and at the end of each pour.
- An agreed procedure for draught checking.

**No.  
46**  
(cont)

- The reporting of any damage to the ship from the cargo operations.

The ship's officer responsible for the cargo operation plan should submit the proposed loading/unloading plan to the cargo terminal representative at the earliest opportunity to allow sufficient time for any subsequent modifications and to enable the terminal to prepare accordingly. The ship's officers should be familiar with the IMO Ship/Shore Safety Checklist.

~~From 1st July 1998, it will be a mandatory requirement of~~The SOLAS Convention required that:

- the plan, and any subsequent amendments thereto, shall be lodged with the appropriate authority of the port state,
- the ship's Master and the terminal representative shall ensure that the cargo operations are conducted in accordance with the agreed plan.

#### **4.1.4 Before Commencing Cargo Operations**

The cargo terminal should not commence any cargo operations until the loading/unloading plan and all relevant procedures have been agreed and the ship's Master has, where necessary, received a Certificate of Readiness issued by the respective maritime authorities.

Prior to the commencement of cargo loading operations, it should be determined that:

- No structural damage exists. Any such damage is to be reported to the respective classification society and cargo operations are not to be undertaken.
- The bilge and ballast systems are in satisfactory working condition.
- Moisture content of the intended cargoes which may liquefy is less than the transportable moisture limit (TML). The cargo shall comply with the requirement of IMSBC.

**No.  
46**

(cont)

**4.2 Monitoring and Controlling Cargo Operations****4.2.1 Monitoring of Stevedoring Operation**

The officer in charge has responsibility for the monitoring of the stevedoring operation and should ensure that:

- The agreed loading/unloading sequence is being followed by the terminal.
- Any damage to the ship is reported.
- The cargo is loaded, where possible, symmetrically in each hold and, where necessary, trimmed.
- Effective communication with the terminal is maintained.
- The terminal staff advise of pour completions and movement of shoreside equipment in accordance with the agreed plan.
- The loading rate does not increase beyond the agreed rate for the loading plan.

If there is likely to be a change by the terminal to either the loading/unloading sequences or the cargo loading/unloading rate, the officer in charge is to be informed with sufficient notice. Changes to the agreed loading/unloading plan are to be implemented with the mutual agreement of both the ship and the terminal.

If a deviation from the loading/unloading plan is observed, the officer in charge should advise the cargo terminal immediately so that necessary corrective actions are implemented without delay. If considered necessary, cargo and ballasting operations must stop.

**4.2.2 Monitoring the Ship's Loaded Condition**

The officer in charge should closely monitor the ship's condition during cargo operations to ensure that if a significant deviation from the agreed loading/unloading plan is detected all cargo and ballast operations must STOP.

The officer in charge should ensure that,

- the cargo operation and intended ballast procedure are synchronised.
- draught surveys are conducted at appropriate steps of the loading plan to verify the ship's loading condition. The draught readings, usually taken at amidships and the fore and aft perpendiculars, should be in good agreement with values calculated in the loading plan.
- ballast tanks are sounded to verify their contents and rate of ballasting/deballasting.
- the cargo load is in agreement with the figures provided by the terminal.
- the cargo is loaded/unloaded in compliance with the ship's approved Local Loading Diagram (Hold Mass Curve) for each cargo hold, where applicable.
- the SWSF, SWBM and, where appropriate, hold cargo weight versus draught calculations are performed at intermediate stages of the cargo operation. These results should be logged, for recording purposes, against the appropriate position in the

**No.**  
**46**  
(cont)

loading plan.

Following a deviation from the loading plan, the officer in charge should take all necessary corrective actions to:

- Restore the ship to the original loading/unloading plan, if possible, or
- Replan the rest of the loading/unloading operation, ensuring that the stress and operational limits of the ship are not exceeded at any intermediate stages.

The modified loading/unloading plan should be agreed by both the officer responsible for the loading plan and the cargo terminal representative. Cargo operations should not resume until the officer in charge gives a clear indication to the terminal of his readiness to proceed with the cargo operation.

#### **4.2.3 Hull Damage Caused by Cargo Operations**

All damages should be reported to the ship's Master. Where hull damage is identified, which may affect the integrity of the hull structure and the seaworthiness of the ship, the ship's owner and classification society must be informed.

A general inspection of the cargo spaces, hatch covers and deck is recommended to identify any physical damage of the hull structure. Any structural damage found is to be reported to the classification society and for major damage, cargo operations are not to be undertaken.

**No.**  
**46**  
(cont)**5. Potential Problems****5.1 Deviation from the Limitations Given in the Approved Loading Manual**

Exceeding the permissible limits specified in the ship's approved loading manual will lead to over-stressing of the ship's structure and may result in catastrophic failure of the hull structure. When deviating from the cargo load conditions contained in the ship's approved loading manual, it is necessary to ensure that both the global and local structural limits are not exceeded. It is important to be aware that over-stressing of local structural members can occur even when the hull girder still water shear forces (SWSF) and bending moments (SWBM) are within their permissible limits.

Exceeding the maximum permissible cargo load in any hold will lead to over-stressing of local structure. Over-stressing of the local structure will occur when:

- The weight of cargo loaded into a hold exceeds the maximum permissible value specified at full draught.
- The weight of cargo loaded into adjacent holds exceeds the maximum combined value at full or reduced draught.

Over-stressing of the local structure may also occur when the weight of cargo loaded into an individual hold has insufficient support of upward buoyancy force; this circumstance can occur when cargo is transported by the ship in a shallow draught condition (for example, partial load condition with some holds full and remaining holds empty).

**5.2 Loading Cargo in a Shallow Draught Condition**

To minimise the risks of over-stressing the local structure, the largest possible number of non-successive pours should be used for each cargo hold.

Loading cargo in a shallow draught condition can impose high stresses in the double bottom, cross deck and transverse bulkhead structures if the cargo in the hold is not adequately supported by the buoyancy ~~up thrust~~ up thrust. If applicable, the cargo weight limits for each cargo hold, and two adjacent cargo holds, as a function of draught, (the local loading criteria) are not to be exceeded.

**5.3 High Loading Rates**

High loading rates may cause significant overloading within a very short space of time. The officer in charge should be prepared to STOP cargo operations if the loading operation deviates from the agreed loading plan.

There are three main problems associated with high loading rates which may result in over-stressing the ship's structure, namely:

- The sensitivity of the global hull girder SWSF and SWBM (An example is presented in Table 1 for illustration purpose only and may not reflect a realistic loading condition).
- Overloading the local structure.
- Synchronisation of the ballasting operations.

# No. 46

(cont)

From the example given in Table 1, the inadvertent loading of 900 tonnes into each of the holds numbered 1 and 7 took 5.4 minutes if two loaders were in operation. The re-distribution of cargo causes the SWSF and SWBM to exceed the allowable limits by 17 and 33 percent respectively.

**Table 1: An Example of the Sensitivity of the Hull Girder to Cargo Distribution of a Bulk Carrier with 7 Holds.**

Loading Condition	Hold 1 (tonnes) <i>see note 1</i>	Hold 3 (tonnes)	Hold 5 (tonnes)	Hold 7 (tonnes) <i>see note 1</i>	Maximum SWSF (tonnes) <i>see note 2</i>	Maximum SWBM (tonnes-m) <i>see note 2</i>
Approved ore load condition	16,000	18,000	18,000	16,000	4,900 (97%)	144,700 (99%)
10% cargo of No.5 hold evenly loaded to holds 1&7	16,900 (5.4 mins)	18,000	16,200	16,900 (5.4 mins)	5,900 (117%)	193,500 (133%)
Notes:						
1. The time taken to load the additional cargo is presented in the parenthesis under the respective hold cargo weight, assuming a loading rate of 10,000 tonnes per hour.						
2. Figures in parenthesis in the SWSF and SWBM columns are the respective percentages of permissible.						

High cargo loading rates may create problems with the ballasting operation as the pumping capacity of the ship may be relatively low compared to the cargo loading rate. In such cases the cargo operation must be stopped to ensure synchronisation with the ballasting operation is maintained. When necessary, the loading rate must be adjusted to synchronise with the ship's pumping capacity.

## 5.4 Asymmetric Cargo and Ballast Distribution

It is recommended that high density cargo be stowed uniformly over the cargo space and trimming be applied to level the cargo, as far as practicable, to minimise the risk of damage to the hull structure and cargo shift in heavy weather.

The distribution of cargo in a hold, and water ballast distribution, have an important influence on the resultant stress in the hull structure. The double bottom and the cross deck structure are designed based upon a trimmed cargo distributed symmetrically in a hold space. Still water shear forces and bending moments given in the ship's loading manual and the corresponding calculations from onboard loading instruments are based on an even distribution of cargo in a hold space, unless otherwise indicated.

Still water shear force and bending moments calculated with an onboard loading instrument do not consider the torsional loads acting on the hull girder resulting from asymmetrical cargo or ballast loading



**No.**  
**46**  
(cont)

When heavy cargo is poured into a cargo space at one end of the cargo hold, the lateral cargo pressure acting on the transverse bulkhead, as a result of the cargo piling up at one end of the cargo space (see figure 16), will increase the loads carried by the transverse bulkhead structure and the magnitude of transverse compressive stresses in the cross deck.

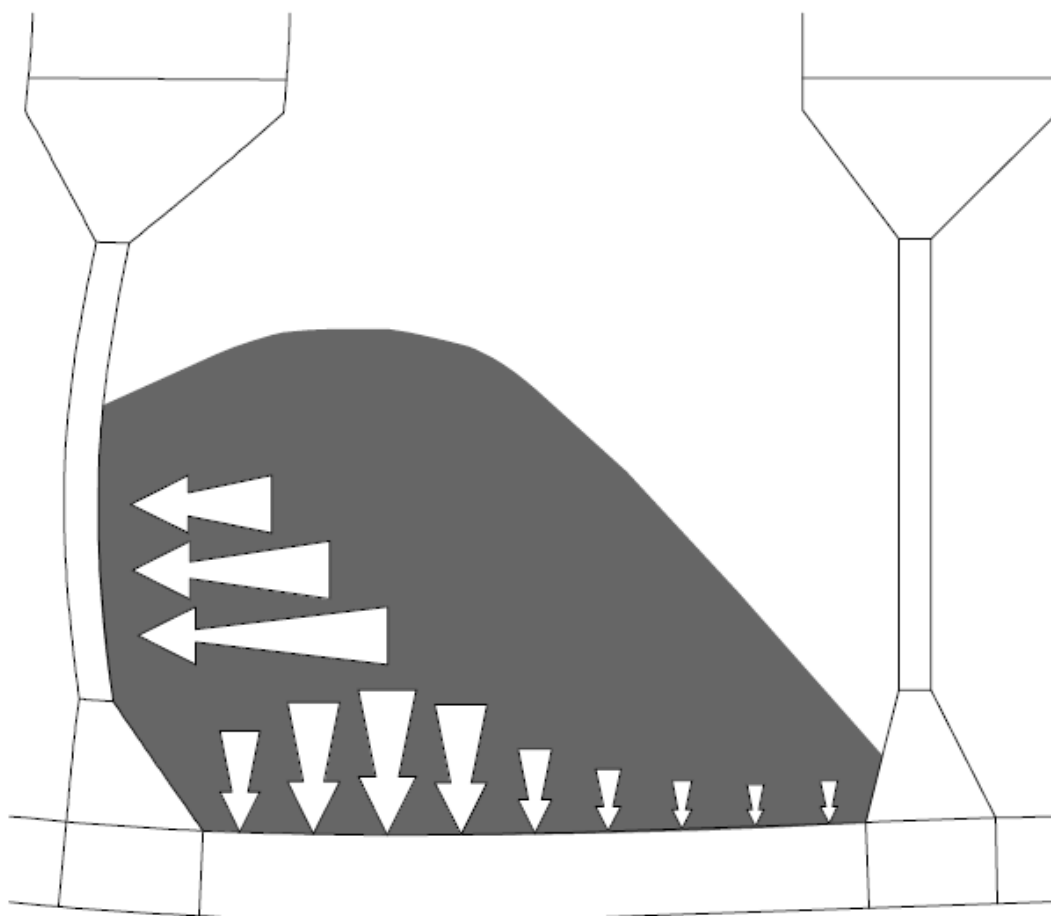
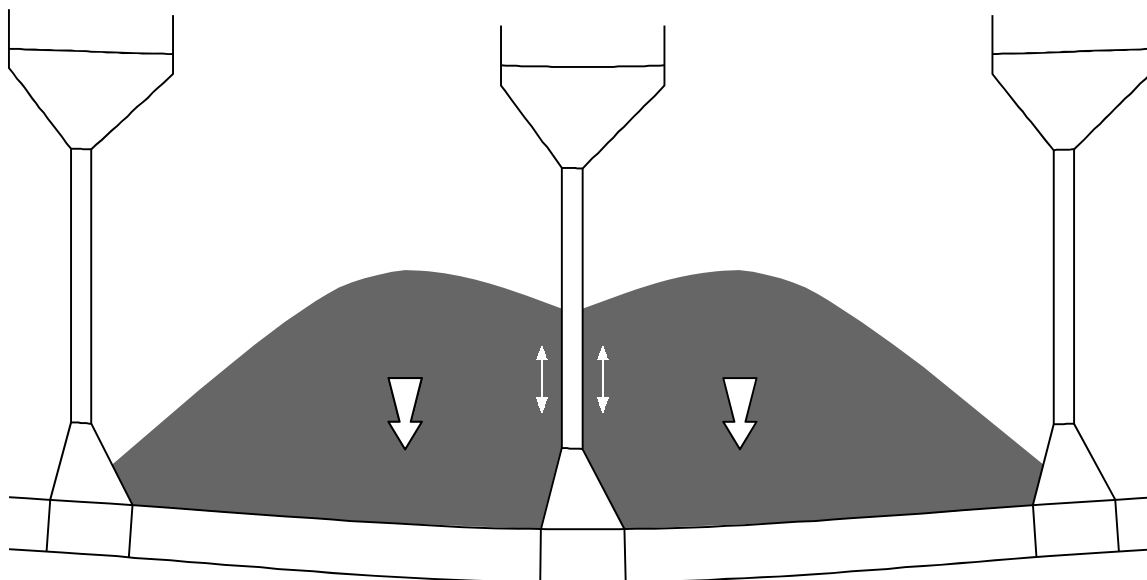

**Figure 16: Asymmetric Longitudinal Cargo Distribution Within a Hold**

# No. 46

(cont)

When the same loading pattern is also adopted for the adjacent cargo hold (Figure 17), the lateral cargo pressure acting on the transverse bulkhead will be largely cancelled out. However, in this situation, a large proportion of the vertical forces on the double bottom is transferred to the bulkhead between the two loaded holds which could lead to shear buckling of the transverse bulkhead structure, compression buckling of the cross deck and increased SWBM in way of the transverse bulkhead. Cargo should always be stowed symmetrically in the longitudinal direction, and trimmed, as far as practical.



**Figure 17: Asymmetric Longitudinal Cargo Distribution Within Adjacent Holds**

Stowing cargo asymmetrically about the ship's centre line in a cargo space (see figure 18) induces torsional loads into the structure which causes twisting of the hull girder. When the hull girder is subjected to torsion, warping of the hull section occurs which gives rise to shearing and bending of the cross deck structure.

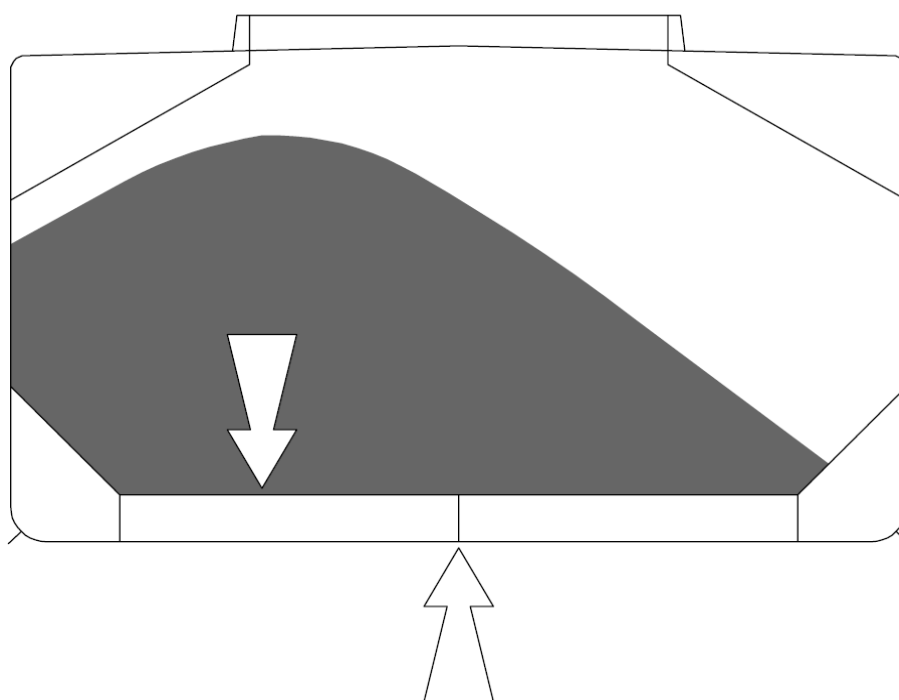

**Figure 18: Asymmetric Transverse Cargo Distribution Within a Hold**

# No. 46

(cont)

Water ballast should always be carried symmetrically in port and starboard tanks with equal levels of filling. The final fill level of all water ballast tanks and holds must satisfy the requirements specified in the ship's approved loading manual to avoid damage to the internal structure due to sloshing effects.

The ballasting and deballasting of port and starboard ballast tanks should be carried out simultaneously so that the amount of water ballast in each corresponding pair of port and starboard ballast tanks remains the same through-out ballasting or deballasting operations, see figures 19 and 20. Asymmetrical distribution of water ballast induces torsional loads, causing twisting of the hull girder.

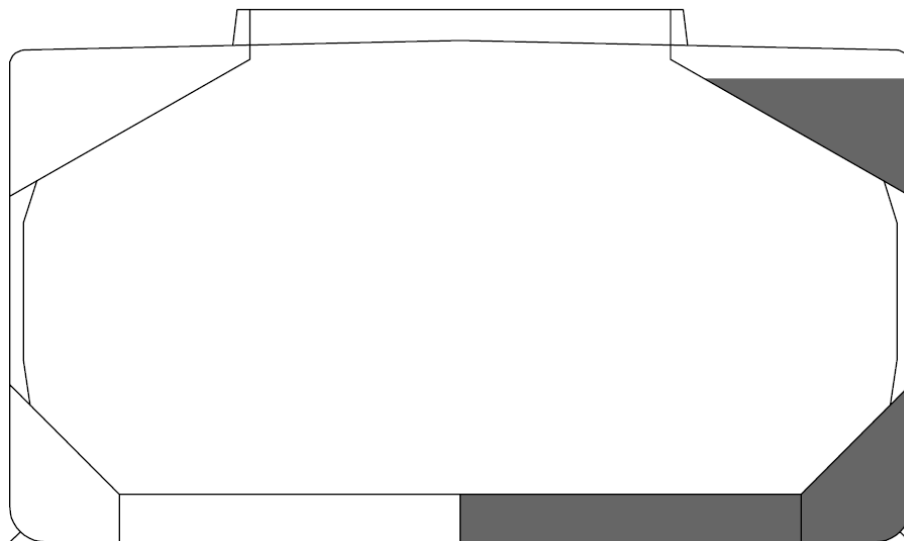

**Figure 19: Asymmetric Transverse Distribution of Water Ballast**

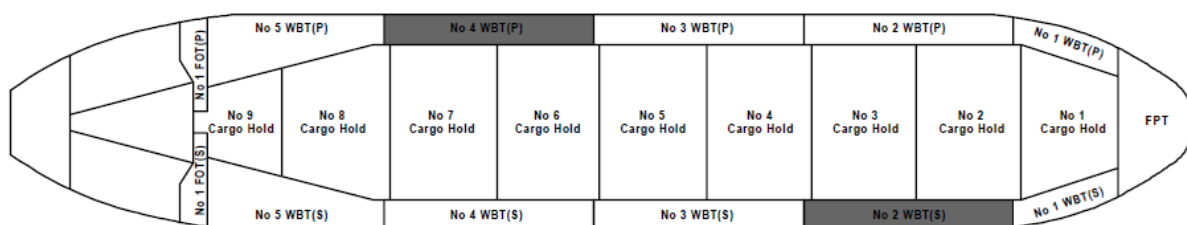

**Figure 20: Asymmetric Longitudinal Distribution of Water Ballast**

Torsional loading of the hull girder is considered to be an important contributory factor to recurring cracking at the hatch corners and to problems associated with hatch cover alignment and fittings. In extreme cases, this can lead to extensive buckling of the cross deck structure between the hatch openings.

## 5.5 Lack of Effective Ship/Shore Communication

The lack of effective ship/shore communication may increase the risk of inadvertent overloading of the ship's structure. It is important that there is an agreed procedure between the ship's officers and the terminal operators to STOP cargo operations. The communication link established between the ship and the terminal should be maintained throughout the cargo operation.

**No.**  
**46**  
(cont)

### **5.6 Exceeding the Assigned Load Line Marks**

All ships engaged on international voyages are assigned with load line marks in accordance with the provisions of the International Load Line Convention 1966. The appropriate lines marked on the ship's side shall not be loaded to submerged the appropriate load line marks at any time during the seagoing voyage. To allow for the difference between the dock water density and the sea water density, the ship may be loaded beyond the appropriate mark by the dock water allowance. The dock water allowance is only applicable in a port environment. It is a statutory requirement that the ship is not to be loaded beyond the limits specified in the Load Line Certificate.

The practice of inducing a hogging deflection of the hull girder by end hold(s) trimming to maximise the cargo carrying capacity of the ship to the appropriate marks is to be avoided as this may result in the over-loading of the end holds beyond the allowable limit and an increase in both the local and global stresses.

### **5.7 Partially Filled Ballast Holds or Tanks**

Sailing with partially filled ballast holds is prohibited unless the approved loading manual approves of such a practice. Cargo holds designed for partially filled in harbour for the purpose of reducing the ship's air draught are not to contain any water ballast while at sea.

Where ballast holds, and in some instances ballast tanks, are partially filled, there is the likelihood of sloshing. Sloshing is the violent movement of the fluid's surface in partially filled tanks or holds resulting from the motion of the ship in a seaway. Sloshing will result in the magnification of dynamic internal pressures acting on the hold/tank boundaries. For any tank design, dimensions, internal stiffening and filling level, a natural period (frequency) of the fluid exists, which, if excited by the ship's motions, can result in very high pressure magnification (resonance) which can result in damage to the tank/hold's internal structure.

To minimise the effects of sloshing, the liquid's motion needs to be controlled by ensuring that tanks are either pressed up or empty (sloshing can occur at low filling levels).

Where a ship has been specially designed for partially filled ballast tanks and/or hold(s) whilst at sea, the filling levels specified in the ship's loading manual are to be followed.

### **5.8 Inadequate Cargo Weight Measurement During Loading**

During cargo loading operations it is important to ascertain the cargo weight loaded into each individual cargo hold and the associated loading rate. Overloading the cargo hold will increase the stress levels in the ship's structure. At high loading rate ports, where there is no suitably positioned cargo weighing equipment, the ship's cargo officer should request that the terminal stops loading to allow draught surveys and displacement calculations to be performed to ensure compliance with the agreed loading plan.

An appropriately positioned cargo weighing device, which can provide continuously, or at least at each step, an accurate indication of the weight of cargo that has been loaded into each individual hold, is an important piece of equipment which can be used to avoid overloading of individual cargo holds. Therefore, IACS recommends that suitably positioned weighing equipment is installed at all terminals, especially those terminals with high loading rates.

The weight of cargo loaded onboard a ship is normally determined from the ship's draughts and, where fitted, shoreside weighing equipment.

**No.**  
**46**  
(cont)

Overloading of the ship's structure, can result from:

- Inaccurate terminal weighing equipment providing incorrect data.
- The limited time available to check the draught and determine the load onboard especially at high loading rate terminals.
- Loading cargo in a hold, in excessive of the allowable limit, to compensate for partial bunkers.

At some terminals the cargo weighing equipment is positioned at a location, remote from the loading operating position. In such cases it is difficult for the officer in charge to determine how much cargo has been loaded into a specific hold and this equipment may not provide the necessary accurate information.

### 5.9 Structural Damage During Cargo Loading/Unloading

Terminal operators should be aware of the damage that their cargo handling equipment can inflict on the ship's structure. It is important that the protective coatings in cargo holds and water ballast tanks are maintained. The cargo holds and deck areas should be inspected by the ship's deck officers upon completion of cargo discharge to identify any signs of physical damage, corrosion or coating damage to the ship's structure. Where hull damage is identified, which may affect the integrity of the hull structure and the seaworthiness of the ship, it should be reported accordingly to the classification society.

The internal hold structure and protective coatings in the cargo hold and the adjacent double bottom are vulnerable to damage when the cargo is discharged using grabs. The weight of empty grabs can be 35 tonnes. For ships having one of the additional service features BC-A or BC-B the additional class notation GRAB [X] is mandatory, where X is an empty grab weight in tons. The bulk carriers shall be designed for the most extreme grab weight that can be expected during ship life, and it is assumed that larger vessels are more likely to encounter the largest grabs as they will more frequently carry coal and iron ore than handy size ships. For CSR ships contracted for construction on or after 1st July 2015, the minimum mass of the grab is taken as 35 t for vessels with length exceeding 250 m, 30 t for ships between 200 m and 250 m and 20t for smaller vessels. For CSR ships contracted for construction before 1st July 2015, the Grab requirement is applicable to BC-A and BC-B ships and the mass of the grab is taken as 20 t.

Other types of equipment employed to free and clear cargo, including hydraulic hammers fitted to extending arms of tractors and bulldozers can inflict further damage to the ship's structure, especially in way of the side shell and the associated frames and end brackets. Chipping (sharp indentations) and the local buckling or detachment of side frames at their lower connection could lead to cracking of the side shell plating which would allow the ingress of water in to the cargo space.

The protective coatings which that may be required to be applied in the cargo hold are also subject to deterioration caused by the corrosive nature of the cargo, high temperature cargoes, cargo settlement during the voyage and the abrasive action of the cargo. Where no protective coatings have been applied or the applied protective coatings have broken down, the rate of corrosion in that area will greatly increase, especially when carrying corrosive cargoes, such as coal. Corrosion will weaken the ship's structure and may, eventually, seriously affect the ship's structural integrity. The severity of the corrosion attained by a structural member may not be easily detected without close- up inspection or until the corrosion causes serious structural problems such as the collapse or detachment of hold frames resulting in cracks propagating in the side shell.

Impact damage to the inner bottom plating or the hopper sloping plating will result in the

# No. 46

(cont)

breakdown of coatings in the adjacent water ballast tanks, thereby intensifying the rate of structural deterioration.

## 6 Ballast Exchange at Sea

~~It is recommended that approval of a procedure for exchanging ballast water at sea be obtained from the ship's classification society.~~

The International Convention for the Control and Management of Ships' Ballast Water and Sediments, 2004, entered into force globally on 8 September 2017. From the date of entry into force, ships in international traffic are required to manage their ballast water and sediments to a certain standard, according to a ship-specific ballast water management plan.

Ships have to carry:

- A ballast water management plan - specific to each ship, the ballast water management plan includes a detailed description of the actions to be taken to implement the ballast water management requirements and supplemental ballast water management practices;
- A ballast water record book - to record when ballast water is taken on board; circulated or treated for ballast water management purposes; and discharged into the sea. It should also record when ballast water is discharged to a reception facility and accidental or other exceptional discharges of ballast water; and
- An International Ballast Water Management Certificate (ships of 400 gt and above) – this is issued by or on behalf of the Administration (flag State) and certifies that the ship carries out ballast water management in accordance with the BWM Convention and specifies which standard the ship is complying with, as well as the date of expiry of the Certificate.

There are two ballast water management standards (D-1 and D-2).

The D-1 standard requires ships to exchange their ballast water in open seas, away from coastal areas. Ideally, this means at least 200 nautical miles from land and in water at least 200 metres deep. By doing this, fewer organisms will survive and so ships will be less likely to introduce potentially harmful species when they release the ballast water. The D-2 standard specifies the maximum amount of viable organisms allowed to be discharged, including specified indicator microbes harmful to human health.

From the date of entry into force of the BWM Convention, all ships must conform to at least the D-1 standard; and all new ships, to the D-2 standard. Eventually, all ships will have to conform to the D-2 standard. For most ships, this involves installing special equipment to treat the ballast water. A ship undergoing a renewal survey linked to the ship's International Oil Pollution Prevention Certificate after 8 September 2019 will need to meet the D-2 standard by the date of this renewal survey.

A major hazard when carrying out ballast exchange at sea is the sloshing of seawater in ballast tanks and holds, see section 5.7. The variability of the sea and swell conditions in a short period of time is an important factor in deciding whether to exchange ballast water at sea. Responsibility for deciding on whether to exchange ballast at sea must rest with the ship's Master, taking into account the permissible limits in respect of structural strength and stability and the sea and weather conditions prevailing at the time.

**No.  
46**

(cont)

IACS recommends, where the exchange of ballast water at sea is to be carried out, that the following guidelines be followed:

- The ship's Master must ensure that the necessary calculations are carried out at each intermediate step so that:
  - Adequate intact transverse stability is maintained.
  - The permissible seagoing SWSF and SWBM are not exceeded.
  - For each cargo hold and block of cargo hold(s), the combined weight of the cargo in the hold(s) and the water ballast in the double bottom and hopper wing ballast tanks directly in way of that hold(s) does not exceed the allowable Seagoing limits for all intermediate draught conditions.
  - The present and forecast sea and swell conditions must be favourable to ensure that significant sloshing loads, which could cause structural damage to holds or tanks, cannot be generated.
- If the ship has been provided with a ballast exchange sequence and procedure approved by the classification society, it should always be used and followed.
- To minimise the risk of structural damage, the exchange of water ballast at sea should always be carried out in calm weather conditions. All available weather forecasting should be utilised to determine that the weather condition is likely to stay calm within the 'weather window' of the ballast water exchange operation. This 'weather window' should be determined based upon the ballast water exchange sequence and the achievable ballasting/deballasting rates. A sufficient time margin should always be included to allow for any unexpected circumstances such as the breakdown of ballast pumps.
- Ballasting and deballasting of each pair of symmetrical port and starboard wing and double bottom ballast tanks should always be carried out simultaneously, such that the amount of water ballast carried in each tank is always the same, to avoid the introduction of twisting and torsional loads into the hull girder, see section 5.4.
- The progress of the ballast/deballast operation and the weather and sea condition should be closely monitored throughout the ballast exchange operation.
- The practice of continuously pumping in new ballast water from the sea and allowing the old ballast water in the tank to overflow through the tank's ventilation pipes may be considered. However, caution should be exercised as over pressurisation of the ballast tank could result if one or more of the vent lines are obstructed and lead to structural damage.
- If there is any difficulty in establishing a safe ballast exchange sequence, or if there is any doubt in the interpretation of an approved procedure or the stress limits imposed on the ship, no attempt should be made to exchange water ballast at sea.

## Back Cover

The International Association of Classification Societies (IACS) represents the world's major classification societies. Their primary objective is to promote the highest standards of ship safety.

Dedicated to safe ships and clean seas, and with an unrivalled knowledge of the world fleet, IACS makes a unique contribution to maritime safety and regulation - through technical support, compliance verification and research and development.

More than 90% of the world's cargo carrying ships tonnage are is covered by the classification design, construction and through-life compliance Rules and standards set by the eleven twelve Member Societies and two Associates of IACS.

IACS Members classify over 95% of the international fleet of approximately 4,600 bulk-carriers — which represent about 30% of the world's total cargo carrying capacity.